

CITY OF SIMPSONVILLE: CITY COUNCIL BUSINESS MEETING
— AGENDA —

Council Chambers, Simpsonville City Hall | April 14, 2026 | 6 p.m.

1. CALL TO ORDER

Presiding Officer: Paul Shewmaker, Mayor

2. ROLL CALL

Recorder: Ashley Clark, City Clerk

3. PLEDGE OF ALLEGIANCE

4. APPROVAL OF MINUTES

Business Meeting on March 10, 2026

5. CITIZEN COMMENTS

(Code of Ordinances: Chapter 2, Article II, Division 2, Sec. 2-69.b.1) Citizens of the City or others who have standing in the City, such as business owners, shall be entitled to appear before council at regular meetings. Such persons may speak regarding matters that are within the jurisdiction of the City, except for personnel matters. At least 10 minutes prior to the time the meeting is scheduled to commence, such person wishing to appear before council must place his or her name, address, and topic to be addressed on the public comments sign-up list maintained by the City Clerk. Individual comments shall be limited to three minutes.

6. BUSINESS

A. Second Reading of Ordinance Z-2025-02, to propose rezoning of properties located at 118 N.E. Main St. and 124 N.E. Main St.

Jon Derby, Planning Director

B. Second Reading of Ordinance O-2026-03, to amend Division 2 (Junk or Abandoned Vehicles) of Article 2 (Nuisances) of Chapter 18 (Environment)

Jon Derby, Planning Director

C. First Reading of Ordinance Z-2026-01, to propose rezoning of property located at 206 Ladean Court

Jon Derby, Planning Director

D. Resolution R-2026-08, to accept the allocation of Community Development Block Grant and Home Funds from Greenville County Redevelopment Authority as set for Program Year 2026

Tee Coker, City Administrator

E. Resolution R-2026-09, to approve funding for an impact fee study and capital improvement plan that will fund certain municipal facilities and equipment, public safety needs, and recreation facilities (park)

Councilmember Tim Pinkerton, Ward 5

F. Resolution R-2026-10, to include in the Fiscal Year 2026-2027 budget and make immediately effective an approved updated fee schedule for processing public records requests per S.C. Code § 30-4-30(B) of South Carolina Freedom of Information Act, S.C. Code § Title 30, Chapter 4

Justin Campbell, Community Relations Specialist

7. ADJOURNMENT



**CITY OF SIMPSONVILLE: CITY COUNCIL BUSINESS MEETING
— MINUTES —**

Council Chambers, Simpsonville City Hall | March 10, 2026 | 6 p.m.

1. CALL TO ORDER

Presiding Officer: Paul Shewmaker, Mayor

2. ROLL CALL

<u>Councilmember</u>	<u>Present</u>	<u>Absent</u>
Ward 1 – Chad O’Rear	✓	
Ward 2 – Aaron Rupe	✓	
Ward 3 – Shannon Williams		✓
Ward 4 – Sherry Roche	✓	
Ward 5 – Tim Pinkerton	✓	
Ward 6 – Jerry Tuso	✓	
Mayor Paul Shewmaker	✓	



3. PLEDGE OF ALLEGIANCE

4. PRESENTATIONS

A. Heart Huddle AED Awareness through AED Placement and CPR Education

Connor Shaw, Founder of Heart Huddle, gave a presentation on Heart Huddle and awareness of AED placement and CPR education. Mr. Shaw explained he worked with Simpsonville Parks & Recreation Department Director Robbie Davis and Simpsonville Fire Department Training Officer Caleb Carter to place AED units in Simpsonville parks. Mr. Carter was presented with the Life Saving Award for his heroic efforts in saving Mr. Shaw’s life.

B. Greenville County Redevelopment Authority Annual Action Plan

Francisco Arnaiz, Program Manager for Greenville County Redevelopment Authority, presented the GCRA Annual Action Plan for Program Year 2026.

5. APPROVAL OF MINUTES

Minutes from the Business Meeting on Feb. 10, 2026 were approved as written.

6. CITIZEN COMMENTS

There were no citizen comments.

7. BUSINESS ITEMS

A. Second Reading of Ordinance O-2026-01, Proposed ordinance for the issuance and sale of City of Simpsonville, South Carolina Sewer System Revenue Refunding Bond, Series 2026 not exceeding six-million seven-hundred fifty-thousand dollars (\$6,750,000) and other matters relating thereto

Motion by Councilmember Pinkerton with a second by Councilmember Roche to approve Second Reading of Ordinance O-2026-01, Proposed ordinance for the issuance and sale of City of Simpsonville, South Carolina Sewer System Revenue Refunding Bond, Series 2026 not exceeding six-million seven-hundred fifty-thousand dollars (\$6,750,000) and other matters relating thereto. Yes – 6, No – 0. Motion carried.

B. First Reading of Ordinance O-2026-02, Mayor and Council Compensation

Motion by Mayor Shewmaker with a second by Councilmember Roche to approve First Reading of Ordinance O-2026-02, Mayor and Council Compensation. Yes – 2, N – 4. Dissenting: Councilmembers O’Rear, Pinkerton, Rupe, and Tuso. Motion Failed.

C. First Reading of Ordinance O-2026-03, to amend Division 2 (Junk or Abandoned Vehicles) of Article 2 (Nuisances) of Chapter 18 (Environment)

Motion by Councilmember Roche with a second by Councilmember O'Rear to approve First Reading of Ordinance O-2026-03, to amend Division 2 (Junk or Abandoned Vehicles) of Article 2 (Nuisances) of Chapter 18 (Environment) to the next business meeting. Yes – 6, N – 0. Motion Carried.

D. Resolution R-2026-06, to approve a Second Amendment to the Amphitheatre Naming Rights and Banking Services Agreement and authorize the Mayor to execute the Second Amendment

Motion by Councilmember Roche with a second by Councilmember Rupe to adopt Resolution R-2026-06, to approve a Second Amendment to the Amphitheatre Naming Rights and Banking Services Agreement and authorize the Mayor to execute the Second Amendment. Y – 6. N – 0. Motion Carried.

E. Resolution R-2026-07, to authorize a Local Fund Match for Hazard Mitigation Grant projects to support stormwater improvements including the acquisition of real property in the City of Simpsonville

Motion by Councilmember Pinkerton with a second by Councilmember Roche to approve Resolution R-2026-07, to authorize a Local Fund Match for Hazard Mitigation Grant projects to support stormwater improvements including the acquisition of real property in the City of Simpsonville. Y – 6. N – 0. Motion Carried.

8. ADJOURNMENT 6:46PM



City of Simpsonville – Submission of Agenda Item

(Due at 12 p.m. on the Tuesday prior to the meeting)

To: Ashley Clark, Clerk of Council

From: Jon Derby

Department: Planning

Date Submitted: 02/17/2026

Please include the following item on the agenda for:

Committee of the Whole Meeting (4th Tuesday of the month) **Date:**

Business Meeting (2nd Tuesday of the month) **Date:** 04/14/2026

Second Reading, Ordinance Z-2025-02_118 N.E. Main St. Old City Hall

Agenda Item Title:

Summary of Item / Purpose:

Rezoning of parcels located at 118 N.E. Main St. and 124 N.E. Main St. from B-U, Business Urban to ID, Innovative Development for a mixed-use development of multi-family and commercial retail within our city center

Action Requested of Council:

Discussion Only

First Reading

Second Reading

Approval / Vote

Other:

Are supporting documents attached?

Yes No

AGENDA ITEM

To: City Council –Second Reading

Meeting Date: 4/14/2026

Agenda Item: Proposed rezoning to ID

Subject: Z-2025-02 Proposed rezoning to property located at 118 & 124 NE Main St. Tax Map# 0315.00.02.004.00 & 0315.00.02.001.00

Applicant/Owner: Blue Ridge Land Holdings, LLC

Attachments: Proposed Ordinance Proposed Concept Plan
Proposed Statement of Intent Applicant Material
Consent Letter Locations Maps Development Agreement Traffic Study Renderings

Existing Zoning	Requested Zoning	Surrounding Zoning	Extraterritorial Land Use	Size of Property
B-U, Business Urban	ID	B-U & B-G	Town Center Mixed-Use	2.44 +/- Acres

Brief Description of request

The City of Simpsonville has received a signed petition requesting the rezoning of parcels of land pursuant to Section 7.5 of the Simpsonville Zoning Ordinance. This petition is for two parcels located at 118 & 124 NE Main St (tax map # 0315.00.02.004.00 & 315.00.02.001.00)

The applicant has requested that these two parcels be rezoned from B-U, Business Urban to ID (Innovative Development). The developer is looking to create a mixed-use development of multifamily and commercial retail within our city center.

Nothing has changed since the first reading on December 9th, 2025. Staff has been coordinating with Walker Consultants to conduct a downtown parking study. This study will provide the City a better understanding of its current and future availability for parking. Once complete, staff plans to present this study to council.

Z-2025-02

Location & Site Description

These parcels contain the prior City Hall site and the vacant AAA/Suntrust building, with surface parking on the rear portions. These parcels will be combined as one tax parcel in the future, fronting NE Main St., E. College St., & Hedge St.

Statement of Intent

The Statement of Intent details a three-story, multifamily, mixed-use project, with surfacing parking on the eastern side near Hedge St. The development will consist of a maximum 80 residential units comprised of studio, one, two, & three-bedroom units. 18,000 square feet of commercial space will be provided on the main level, fronting NE Main St. & E. College St. Access points will be installed on E. College St. and on Hedge St. 144 surface parking spaces are being provided, hidden from Main St, behind the structure. Coworking spaces and flexible office units will be integrated into the project. The development will incorporate public art and streetscape elements to coincide with the city's downtown streetscape project. The development is proposing the use of EV (Electric Vehicle) charging stations as well as solar power concepts to promote renewable energy options.

Comprehensive Plan

The City's Comprehensive Plan identifies this area as Town Center Mixed Use. This designation applies only in and around Downtown Simpsonville. It emphasizes the urban character and the mix and intensity of activities uniquely suited to the town center. This designation is intended to permit a true mix of all uses, except industrial, at the highest levels of scale and density within the City and with unique development standards tailored to the urban character of Downtown. It is particularly important to move the Downtown towards becoming a center of activity not only in the day, but also at night and during weekends, by promoting a mix of commercial, entertainment, residential, and other uses. To help achieve this goal, creative forms of housing, such as lofts and residential units in second-stories above ground level retail, should be encouraged....

Zoning District

Per Section 2.11.1 of the Simpsonville Zoning Ordinance: "the ID, Innovative Development District is established to provide flexibility in the planning and construction of development

Z-2025-02

projects in accordance with an approved plan. In return for greater flexibility in site design requirements, innovative development are expected to demonstrate exceptional quality community designs that:

- A. Preserve critical environmental resources;
- B. Provide above-average open space amenities;
- C. Demonstrate innovative and creative site planning techniques that improve upon the layout and design of buildings, open space and circulation that would otherwise be achieved by the standards of other allowable zoning districts;
- D. Assure compatibility with surrounding land uses and neighborhood character; and
- E. Provide greater efficiency in the layout and provision of roads, utilities, and other infrastructure.”

Site Improvements

The current overhead transmission lines, running in front of the old AAA/Suntrust building will be placed underground to allow for maximum use of the site. This will allow for this project to have a 0’ build line, along Main St and E. College St. Current vehicle access points along Main St will be removed, allowing for more fluid traffic movement for this stretch of Main St., while encouraging more walkability along the streetscape.

Public Hearing Proceeding

A public hearing regarding this petition was conducted on November 6th, 2025, before the body of the Simpsonville Planning Commission. There was only one public comment, in favor of the request with recommendation of color and pattern design.

Planning Commission Review

The Simpsonville Planning Commission reviewed the request to rezone the property at their November 6th, 2025, meeting. The Commission discussed the ingress/egress along with the proposed unit counts. The topic of parking was discussed, and their Traffic Engineer was available to answer other questions. By a vote of 4-0, the Planning Commission recommends approval of Z-2025-02.

Staff Comments

A traffic study has been conducted by the developers to determine potential impact from the proposed project. This project will be the first ground-up construction in the commercial core of the city in several years. The proposed design of the project will incorporate the materials and colors accustomed to our city theme, while introducing

Z-2025-02

fresh, innovative design elements that breathe new life into the area.

STAFF RECOMMENDATION: Approval of the requested rezoning set forth in Ordinance Z-2025-02.

ORDINANCE NO. Z-2025-02

AN ORDINANCE TO AMEND THE ZONING MAP OF THE CITY OF SIMPSONVILLE, SOUTH CAROLINA OF LAND AT 118 NE MAIN STREET, & 124 NE MAIN STREET., TAX MAP# 0315.00-02-004.00, & 0315.00-02-001.00 OWNED BY BLUE RIDGE LAND HOLDINGS, LLC

WHEREAS, the South Carolina Code of Laws of 1976, as amended, Chapter 23 Title 5 provides for the process for municipalities to rezone property; and

WHEREAS, the City of Simpsonville has enacted a Zoning Ordinance which governs amendments to the Official Zoning Map; and

WHEREAS, the hereinafter described property was advertised on October 19, 2025, and the City of Simpsonville Planning Commission held a public hearing on November 6, 2025.

NOW, THEREFORE, BE IT ORDAINED BY THE CITY COUNCIL OF THE CITY OF SIMPSONVILLE THAT:

1. **ZONING CLASSIFICATION:** The Official Zoning Map of the City of Simpsonville is hereby amended to assign Tax Map # 0315.00-02-004.00 depicted in the deed contained in Book 2759 on Page 834, & Tax Map# 0315.00-02-001.00 depicted in the deed contained in Book 2623 on Page 2891, of the official records of Greenville County Register of Deeds and as depicted in Exhibit "A" & "B", attached hereto, the zoning classification of I-D, Innovative Development District.

2. **PROVISION SEVERAGE:** It is hereby declared to be the intention of the governing authority of this municipality that the sections, subsections, paragraphs, sentences, clauses and phrases are severable, and if any phrase, clause, sentence, paragraph, subsection, or section of this Ordinance shall be declared invalid or unconstitutional by the valid judgment or decree of any court or competent jurisdiction, such invalidity or unconstitutionality shall not effect any of the remaining portions of this Ordinance so held to be invalid.

3. **ORDINANCE SUPERSEDES PREVIOUS INCONSISTENT LEGISLATION:** All Ordinances or parts of Ordinances inconsistent herewith, which may have heretofore been passed by the Simpsonville City Council, are hereby repealed.

(SIGNATURE PAGE FOLLOWS)

ORDINANCE NO.: Z-2025-02

Page 2

This Ordinance shall be effective upon second and final reading by the City Council.

SIGNATURE OF MAYOR:

Paul Shewmaker

ATTEST:

APPROVED AS TO FORM:

Ashley Clark
City Clerk

Daniel Hughes
City Attorney

First Reading: December 9, 2025
Second Reading: April 14, 2026

EXHIBIT B

Z-2025-02 118 & 124 NE. Main St Rezoning to I-D



October 30, 2025

1:1,600

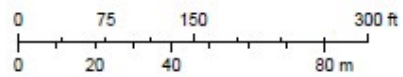
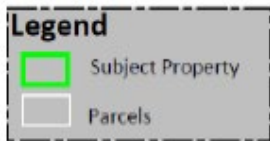



SITE INFORMATION:
 TM#: 0315000200100, 0315000200400
 SIZE: ±2.52 ACRES
 EXISTING ZONING: B-U (BUSINESS - URBAN)
 PROPOSED ZONING: ID (INNOVATIVE DEVELOPMENT)
 SETBACKS: -FRONT = NONE
 -SIDE = NONE
 -REAR = NONE
PARKING REQUIREMENTS:
 STALL WIDTH
 90-DEGREE STALL= 9-FT X 18FT 24-FT AISLE
 PROVIDED PARKING COUNT: 144 SPACES
 PASSENGER: 139 SPACES
 ADA: 5 SPACES
PROPOSED BUILDING:
 MIXED USE DEVELOPMENT
 3 STORIES

PROPOSED BUILDING INFORMATION:

	RESIDENTIAL	AMENITY	RETAIL	COMMERCIAL	TOTAL
LEVEL 1	13,994	6,147	8,991	3,823	32,955
LEVEL 2	32,955				32,955
LEVEL 3	32,955				32,955
TOTAL	79,904	6,147	8,991	3,823	98,865

RESIDENTIAL UNIT COUNT: 73

NOTE: BOUNDARIES, TOPOGRAPHY, WETLANDS, AND STREAMS LOCATIONS ARE APPROXIMATE BASED OFF GEOGRAPHIC INFORMATION SYSTEMS (GIS). A BOUNDARY AND TOPOGRAPHIC SURVEY ALONG WITH A WETLAND DELINEATION SHOULD BE PERFORMED TO DETERMINE ACCURATE BOUNDARY, TOPOGRAPHIC, AND WETLAND LOCATIONS.

Documents prepared or furnished by Alliance Consulting Engineers, Inc. are instruments of service, and Alliance Consulting Engineers, Inc. retains an ownership and property interest (including the copyright and the right of reuse) in such documents, whether or not the project is completed.

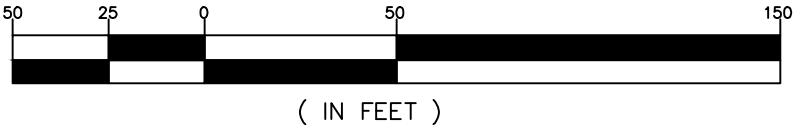

Project No.: 25195-0023
 October 9, 2025



±99,000-SF Mixed-Use Development
Located Along North East Main Street
City of Simpsonville
Greenville County, South Carolina

Blue Ridge Land Holdings, LLC



Burdette North

Statement of Intent for Innovative Development (ID) Rezoning

Project Name: Burdette North

Location: Southeast corner of NE Main Street and E. College Street, Simpsonville, SC

Parcels: Tax Map #0315000200400 (+/- 1.09-Acres) and #0315000200400 (+/- 1.43-Acres)

Current Zoning: Business-Urban

Proposed Zoning: Innovative Development (ID)

Developer: Blue Ridge Land Holdings, LLC

Architect: SHLTR Architects

Civil/Site Design: Alliance Consulting Engineers, Inc.

Traffic Impact Analysis: Impact Designs, Inc.

Surveying: Site Design, Inc.

Project Overview

Burdette North is proposed as a vibrant, mixed-use redevelopment designed to bring new life and economic energy to the north end of Downtown Simpsonville. The project will include up to **80 residential units** (a mix of studios, one-bedroom, and two-bedroom apartments) and **+/-18,000 square feet of commercial space** dedicated to retail, restaurant, amenities, and coworking uses. The building will be a total of three (3) stories.

As shown on the included Conceptual Site Plan, the development will include **144 surface parking spaces**. Both existing structures on the site will be demolished to make way for this new, cohesive urban development that aligns with the City's vision for a more walkable, connected, and active downtown district.

Innovative Features

Burdette North exemplifies the goals of the Innovative Development (ID) zoning by introducing design and sustainability features that are new to the City of Simpsonville's Central Business District and Business Urban (B-U) zones. The project will include at least two (2) of the following innovative components:

- **Coworking Space:** Dedicated coworking suites and flexible office amenities will serve local entrepreneurs, small businesses, and remote professionals, providing modern workspace solutions within a walkable downtown setting.

- **Public Art:** The project will feature integrated public art installations—such as murals, sculptures, or artist-designed streetscape elements—that contribute to placemaking and enhance the visual identity of NE Main and College Streets.
- **Pervious Pavement:** Portions of the parking and pedestrian areas will utilize pervious pavement systems to reduce stormwater runoff, promote infiltration, and improve site sustainability.
- **EV Charging Stations:** Electric Vehicle (EV) charging infrastructure will be provided to support the growing demand for sustainable transportation options.
- **Solar Power:** Where feasible, solar panels will be integrated to supplement building energy use and demonstrate commitment to renewable energy innovation.

These innovative elements will provide a unique character and forward-thinking design approach, establishing Burdette North as a model for sustainable, mixed-use redevelopment in the city.

Community Impact and Vision

Burdette North will bring a new level of vibrancy and activity to NE Main Street and College Street, reinforcing the urban fabric of Downtown Simpsonville. The project’s blend of residential and commercial uses will:

- Activate the public-facing street level with restaurants, retail, and coworking spaces
- Provide diverse housing options that appeal to young professionals, empty nesters, retirees and small households
- Encourage walkability and connectivity with nearby businesses and public amenities
- Support the continued revitalization of the downtown corridor through attractive design and public engagement features

As the second major downtown investment by Blue Ridge Land Holdings, LLC, following the successful redevelopment of Burdette Central, this project continues the developer’s commitment to high-quality, community-oriented growth in the City of Simpsonville. Working with SHLTR Architects and Alliance Consulting Engineers, Inc., the design team will deliver a well-integrated, visually appealing, and environmentally conscious project that enhances both the aesthetic and economic vitality of the city.

Integrating residential uses into the City of Simpsonville’s downtown core brings vitality, economic stability, and a stronger sense of community to the urban environment. Residents living downtown provide support to local businesses, restaurants, and cultural venues, helping sustain activity beyond typical business hours and creating a lively, 24-hour district.

This mix of living, working, and leisure spaces reduces reliance on cars, encourages walking, and fosters a more sustainable urban form. Moreover, downtown living attracts a diverse range of people - young professionals, small families, and retirees alike—who contribute to the social and cultural vibrancy of the area. By combining residential and commercial space, this project will be dynamic, safe, and engaging to the City of Simpsonville’s downtown, and serve as the center of urban life.

Property Access & Traffic Flow Coordination

Vehicle access to Burdette North will be on E. College and Hedge Streets (one ingress/egress on each street). The project team has designed internal circulation to align with the City’s soon-to-be implemented counterclockwise one-way circulation pattern. The Traffic Impact Analysis has accounted for the City’s new traffic pattern. The plan is to have Burdette North’s construction occurring simultaneously with Simpsonville’s Downtown Revitalization and Traffic Realignment strategy and construction. Existing curb cuts along NE Main Street and East College Street will be eliminated, along with one curb cut on Hedge Street.

Eliminating multiple vehicle access points with this development offers several important benefits for safety, efficiency, and overall site design. By consolidating access to two (2) well-designed entrances/exits along E. College Street and Hedge Street, traffic movement becomes more predictable and easier to manage, reducing potential conflict points between vehicles, pedestrians, and cyclists. Fewer access points also enhance roadway safety by minimizing turning movements and improving sight distances along adjacent streets. Overall, limiting vehicle access points contributes to a safer, more attractive, and functionally efficient development.

Utilities

This project will be served by Greenville Water, City of Simpsonville Sewer, and Duke Energy. Duke Energy will locate transformers on the development site. Existing utilities and connections will be used wherever possible. The Development Agreement between Blue Ridge Holdings, LLC and the City of Simpsonville states that the City will use its best efforts to relocate utilities in the public right-of-way, creating a cleaner, less-cluttered aesthetic.

Stormwater

Because the site consists of mostly impervious surface, major stormwater infrastructure improvements are not anticipated being needed, as this project assumes zero increase in runoff. If required through Detailed Design, additional Stormwater Management will be coordinated and compliant with Greenville County under its Stormwater Standards.

Signage

Burdette North will utilize monument signage where feasible on the site and within the City’s Sign Ordinance requirements. The signage type and design will closely resemble existing signage at Burdette Central to maintain consistency of brand.

Landscaping

The developer and design team will adhere to all landscaping requirements as required by City Ordinance. Wherever possible, with Client direction, the team will strive to exceed requirements.

Conclusion

Burdette North represents the next evolution of downtown Simpsonville—an innovative, mixed-use community that strengthens the city’s identity, supports local business, and creates a vibrant, connected environment for residents and visitors alike.

Through thoughtful design, sustainable features, and a commitment to quality development, this project will serve as a catalyst for continued downtown growth and exemplify the purpose and intent of the **Innovative Development (ID) zoning designation**.



E COLLEGE STREET - EXTERIOR ELEVATION
1" = 10'-0"



NE MAIN STREET - EXTERIOR ELEVATION
1" = 10'-0"

NOTE:
SIGNAGE IS SUBJECT TO CHANGE. DRAWINGS REPRESENT CONCEPTS AND POTENTIAL LOCATIONS AT THIS PHASE
FINAL SELECTION OF MATERIALS AND COLOR MAY VARY



VIEW @ CORNER OF NE MAIN STREET & E COLLEGE STREET

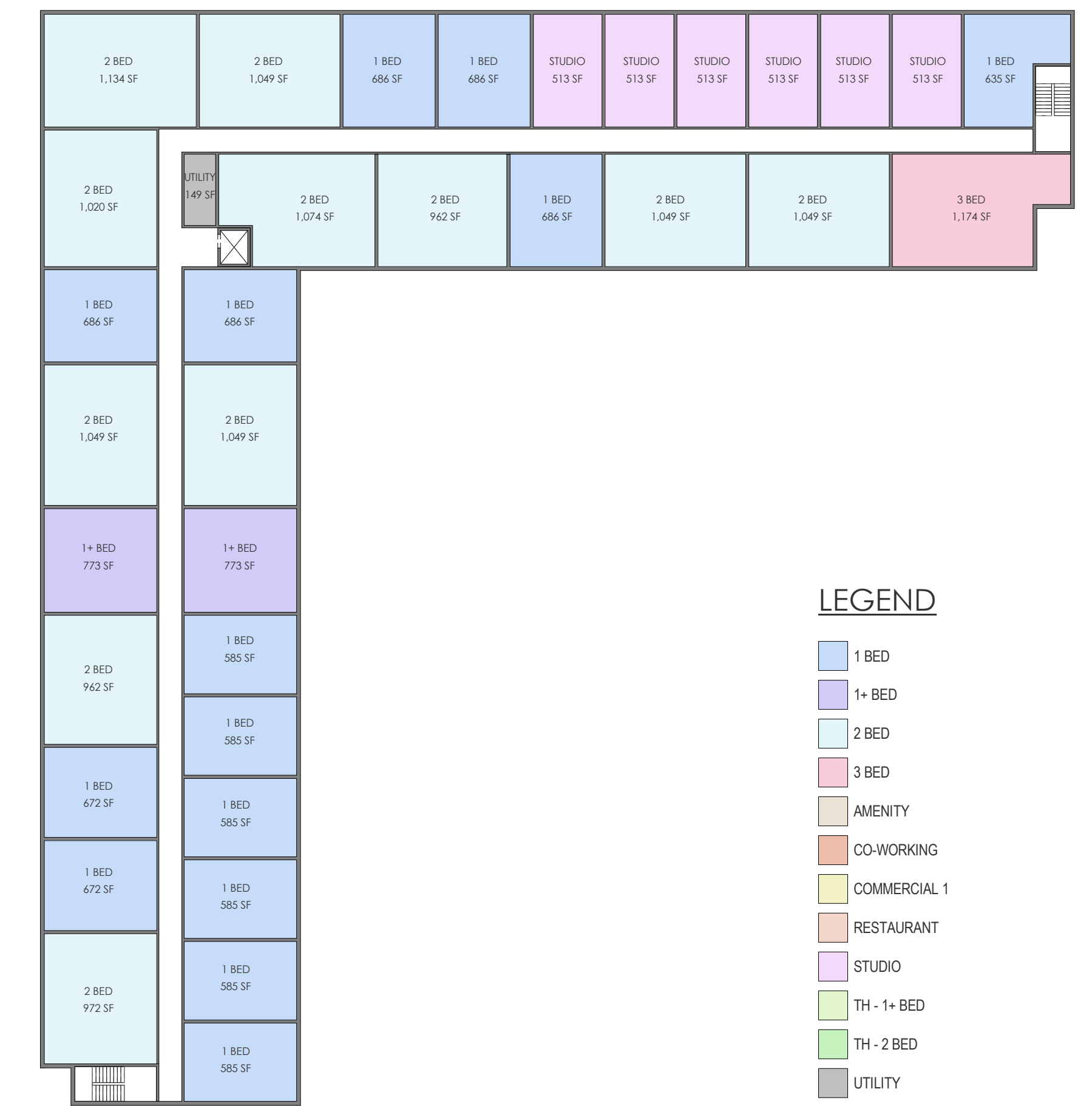
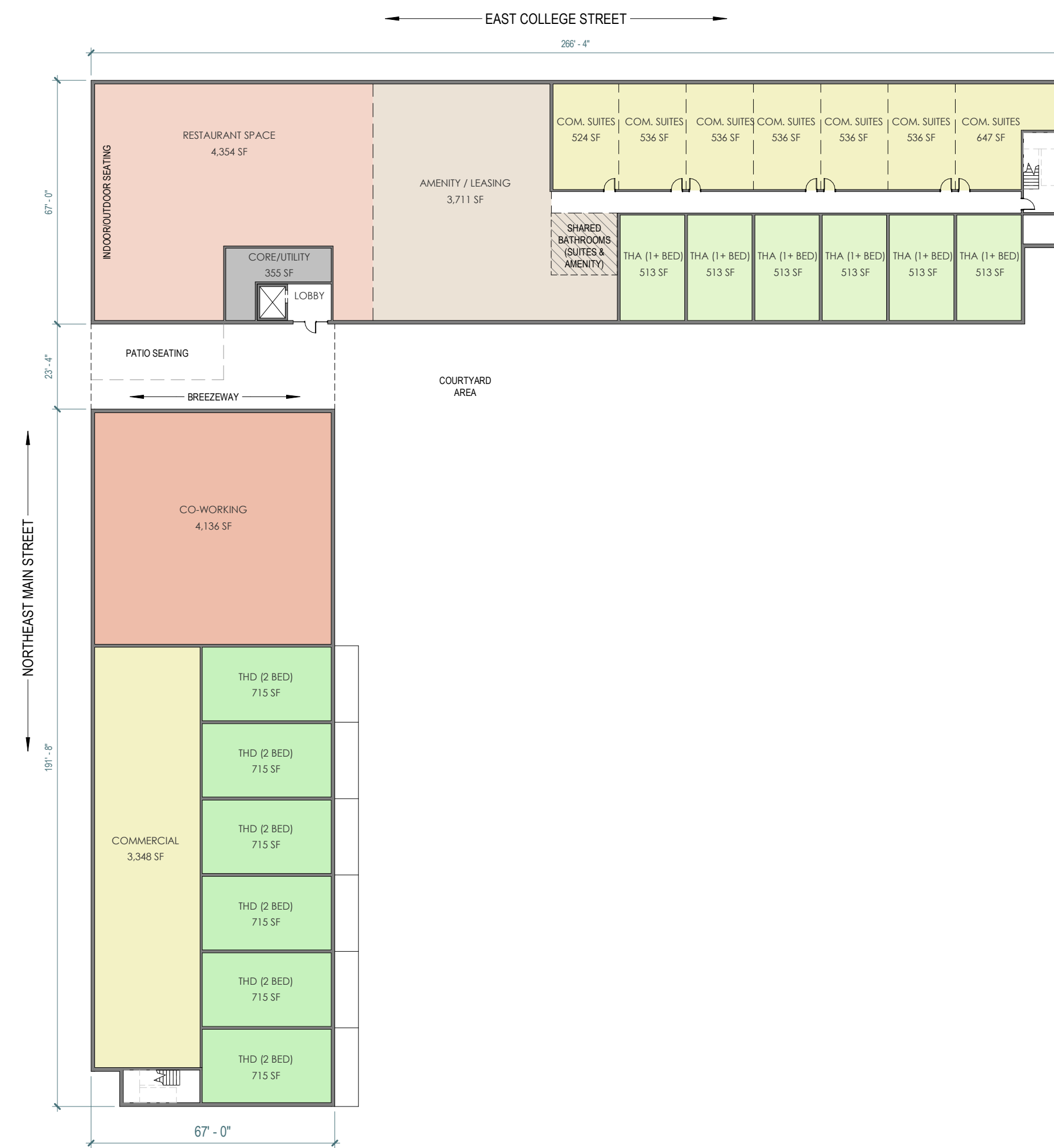

- LEGEND**
- 1 BED
 - 1+ BED
 - 2 BED
 - 3 BED
 - AMENITY
 - CO-WORKING
 - COMMERCIAL 1
 - RESTAURANT
 - STUDIO
 - TH - 1+ BED
 - TH - 2 BED
 - UTILITY

1 OPTION 1 - LEVEL 1
1" = 30'-0"

2 OPTION 1 - LEVEL 2
1" = 30'-0"

3 OPTION 1 - LEVEL 3
1" = 30'-0"



OPTION 1

	STUDIO	1 BED	1+ BED	2 BED	3 BED	TOTAL
L1			6	6		12
L2	6	8	2	9		25
L3	6	14	2	11	1	34
	12	22	10	26	1	71
	17%	31%	14%	37%	1%	

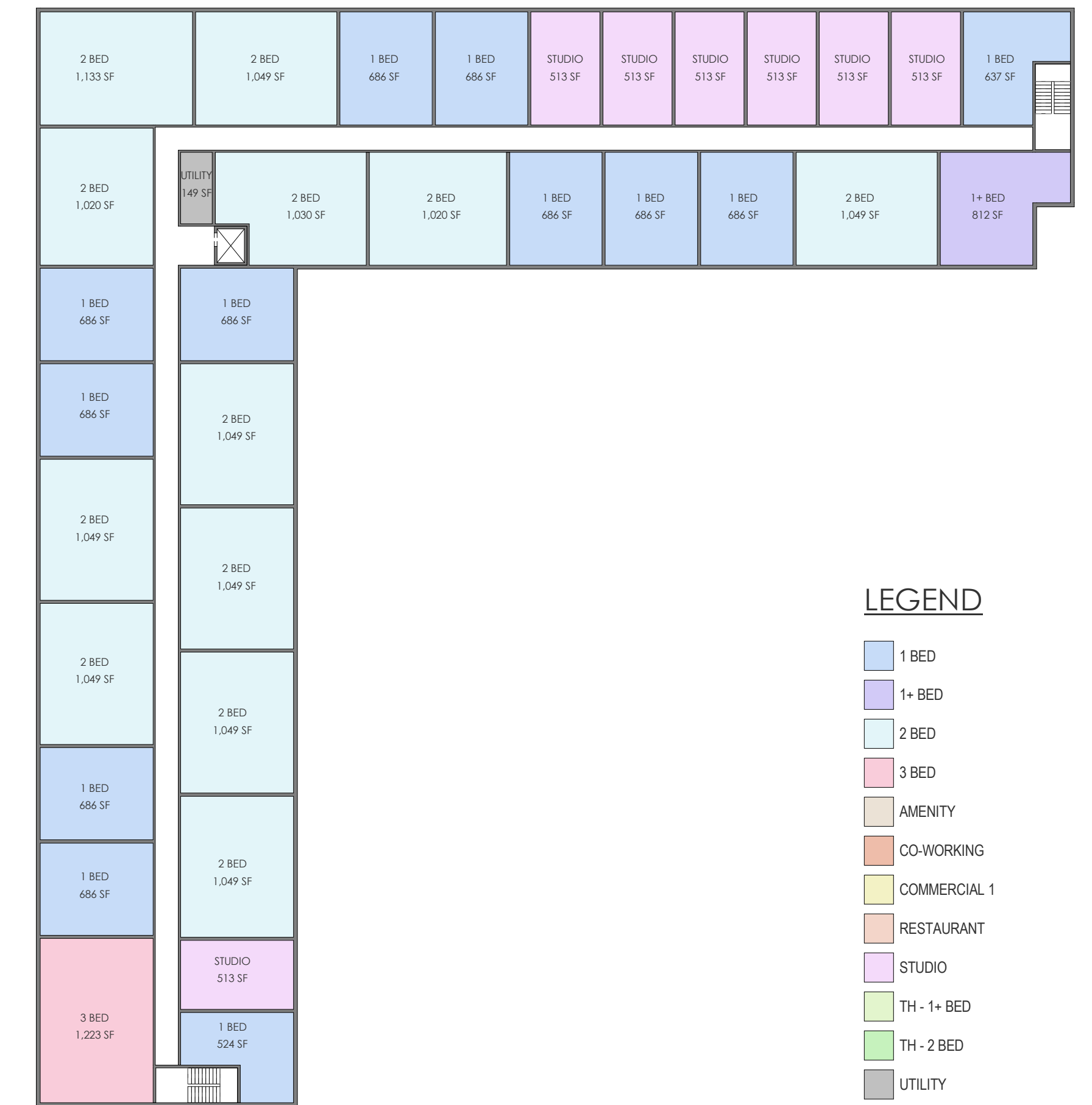
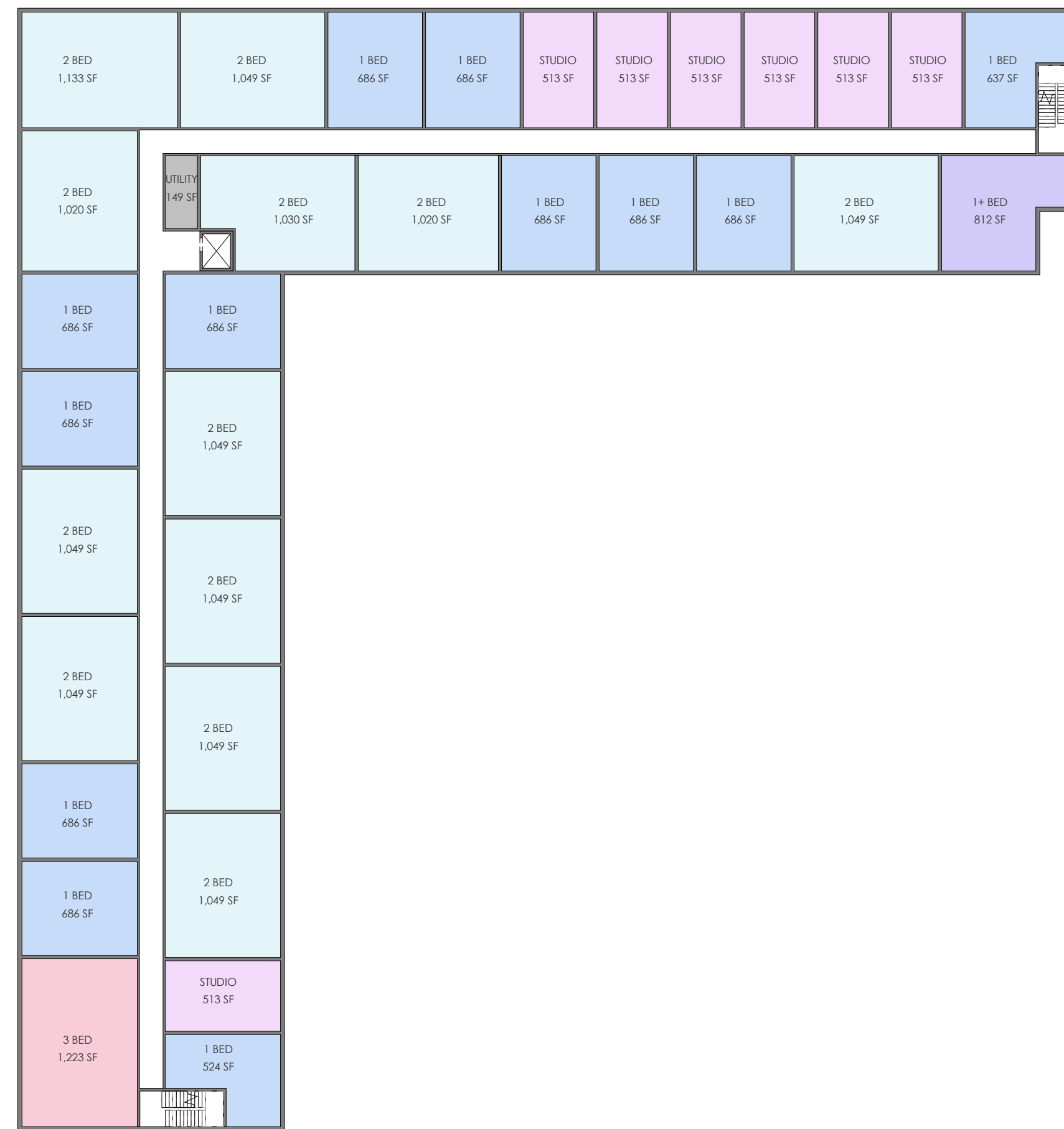

LEGEND

- 1 BED
- 1+ BED
- 2 BED
- 3 BED
- AMENITY
- CO-WORKING
- COMMERCIAL 1
- RESTAURANT
- STUDIO
- TH - 1+ BED
- TH - 2 BED
- UTILITY

1 OPTION 3 - LEVEL 1
1" = 30'-0"

2 OPTION 3 - LEVEL 2
1" = 30'-0"

3 OPTION 3 - LEVEL 3
1" = 30'-0"



OPTION 3

	STUDIO	1 BED	1+ BED	2 BED	3 BED	TOTAL
L1	1	3	1	3		8
L2	7	12	1	12	1	33
L3	7	12	1	12	1	33
	15	27	3	27	2	74
	20%	36%	4%	37%	3%	



CITY OF SIMPSONVILLE
ZONING AMENDMENT (REZONING)
APPLICATION

SITE/PROPERTY LOCATION:

Property Address: 1182124 NE Main St Simpsonville, SC 29681
Tax Map Number: 0315000200100 0315 000200400

APPLICANT: Ryan D. Jones, P.E. Alliance Consulting Engineers, Inc.

Mailing Address: 124 Verdae, Suite 505 City, State, Zip: Greenville, SC 29607

Phone Number: 864-284-1740 E-mail Address: rjones@alliancece.com

PROPERTY OWNER (if different from Applicant): Kenneth Reiter/John Pazdan

Mailing Address: Blue Ridge Land Holdings, LLC Attn: John Pazdan City, State, Zip: PO Box 8856 Greenville, SC 29604

Phone Number: 864-430-6081 E-mail Address: kreiter@belmontsayre.com chanticleer18@gmail.com

Table with 3 columns: Field, Current, Requested. Rows: Zoning District (B-U, ID), 'Future Land Use Map' Designation (N/A, N/A)

Project Description (be specific): Demolition of an existing/former Bank & City Hall and construction of a new Multi/Mixed Use Development in it's place over the two adjoining parcels.

No. of Parcels: 2 Acreage of Parcel(s): +/- 2.52

- Submittal Checklist*: [] Consent Letter from Property Owner... [x] Cover Letter explaining your request in detail [x] Application Fee... [x] Survey/Boundary Map...

*Staff reserves the right to request additional information and/or materials as necessary

I do hereby certify as property owner/authorized agent that the information shown on this application and any attached forms and/or plans is correct.

Signature: [Handwritten Signature] Printed Name: Kenneth M Reiter Date: October 17, 2025

FOR CITY STAFF USE ONLY
Date Received: By: Docket #: Zoning District:
Comments: PC Review: CC Review:
[] APPROVED ([] with conditions) [] DENIED

Z-2025-02 118 & 124 NE. Main St Rezoning to I-D



October 30, 2025

1:1,600

Legend

- Subject Property
- Parcels

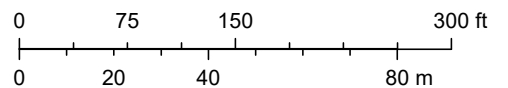

Greenville County GIS Division, Greenville, South Carolina, Greenville County GIS Division, Greenville County, South Carolina GIS Division

Z-2025-02 118 & 124 NE. Main St Rezoning to I-D



October 30, 2025

1:1,600

Legend

- Subject Property
- Parcels

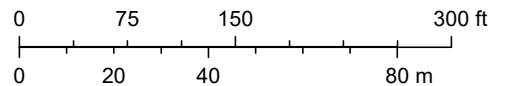

Greenville County GIS Division, Greenville, South Carolina, Greenville County GIS Division, Greenville County, South Carolina GIS Division

NOTE: EXCEPT AS SPECIFICALLY STATED OR SHOWN ON THIS PLAN, THIS SURVEY DOES NOT PURPORT TO REFLECT ANY OF THE FOLLOWING WHICH MAY BE APPLICABLE TO THE SUBJECT REAL ESTATE: RIGHTS-OF-WAY, EASEMENTS, OTHER THAN POSSIBLE EASEMENTS THAT WERE VISIBLE AT THE TIME OF MAKING THIS SURVEY; BUILDING SETBACK LINES; RESTRICTIVE COVENANTS, SUBDIVISION RESTRICTIONS; ZONING OR OTHER LAND USE REGULATIONS AND ANY OTHER FACTS THAT AN ACCURATE AND CURRENT TITLE SEARCH MAY DISCLOSE. - ANY FLOOD PLAIN DATA SHOWN HEREON IS AN APPROXIMATE LOCATION GRAPHICALLY PLOTTED FROM THE REFERENCED FEMA MAP UNLESS OTHERWISE NOTED. - THIS SURVEY DOES NOT CONSTITUTE A TITLE RESEARCH, FLOOD STUDY, WETLAND DELINEATION OR ENVIRONMENTAL INSPECTION BY SURVEYOR.

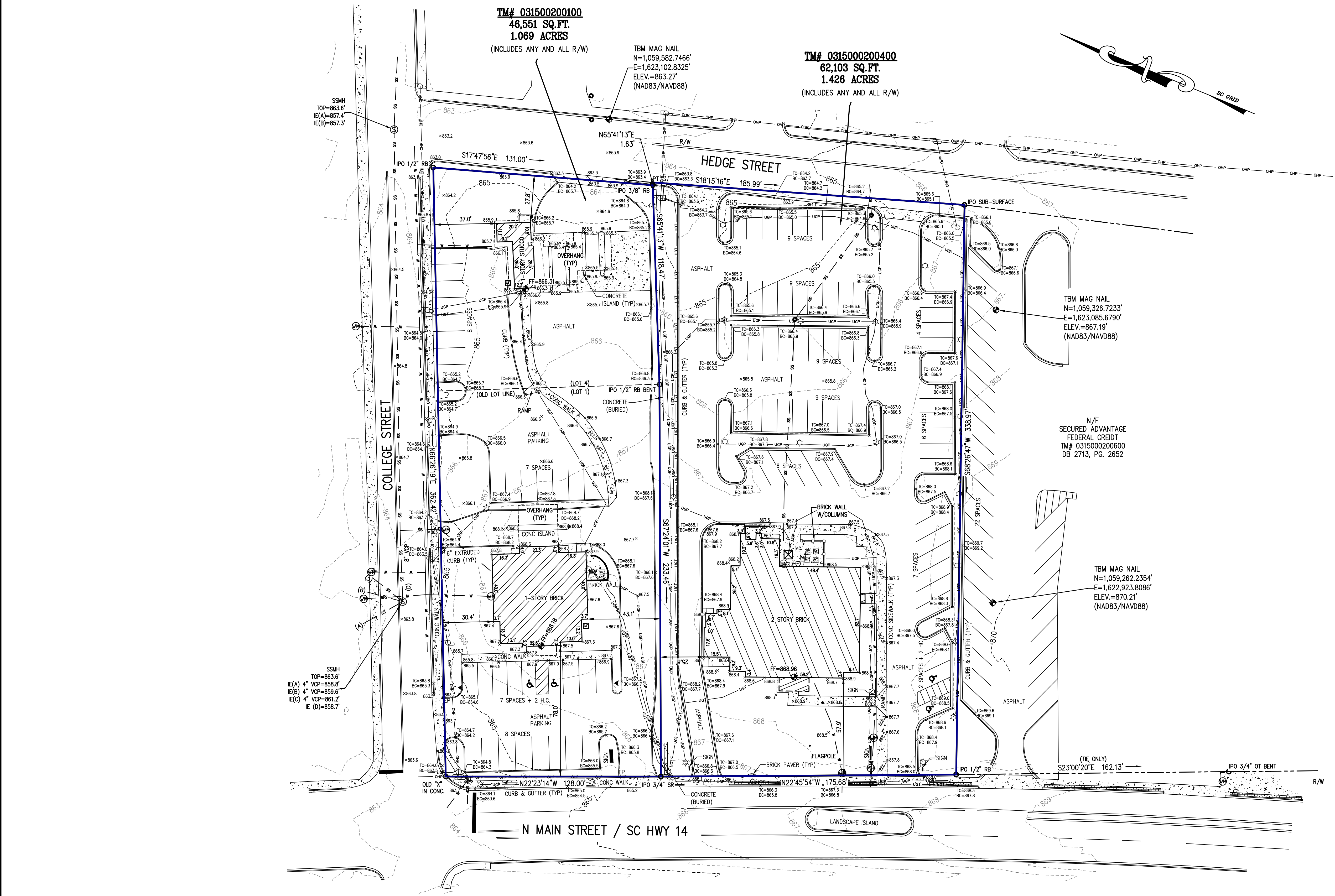
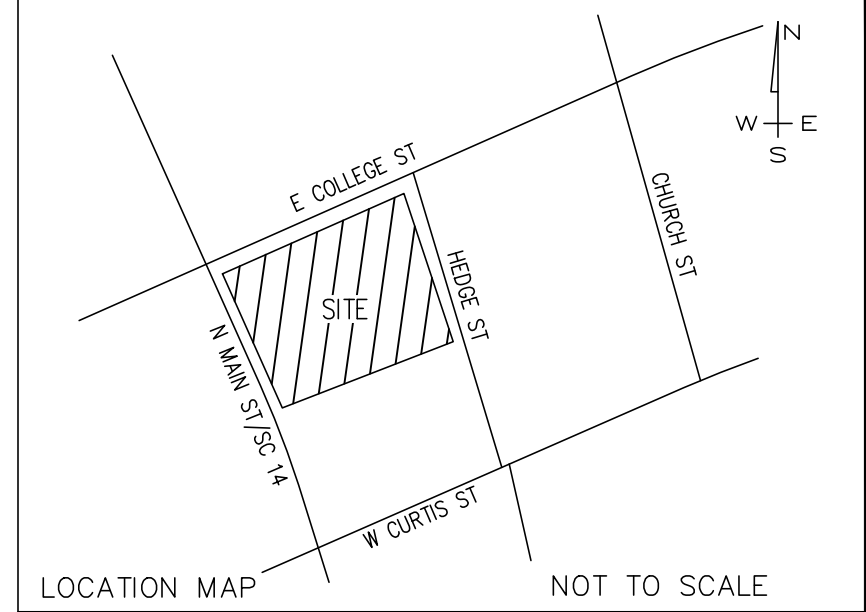

I HEREBY STATE THAT TO THE BEST OF MY PROFESSIONAL KNOWLEDGE, INFORMATION, AND BELIEF, THE SURVEY SHOWN HEREIN WAS MADE IN ACCORDANCE WITH THE REQUIREMENTS OF THE STANDARDS OF PRACTICE MANUAL FOR SURVEYING IN SOUTH CAROLINA, AND MEETS OR EXCEEDS THE REQUIREMENTS FOR A CLASS "A" SURVEY AS SPECIFIED THEREIN; ALSO THERE ARE NO VISIBLE ENCROACHMENTS OR PROJECTIONS OTHER THAN SHOWN.

REFERENCE:
DB. 2623, PG. 2891
PB. 1397, PG. 56
DB. 2759, PG. 834
PB. 1522, PG. 21

A. CLAY JONES, P.L.S.
S.C. REG. NO. 26210

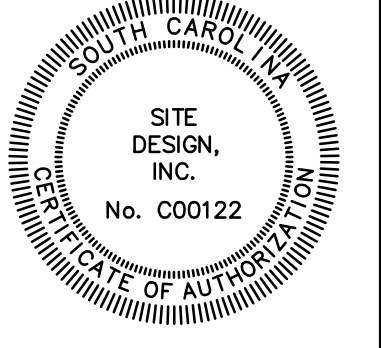

TOPO NOTES:
1. ELEVATIONS ARE BASED ON NAVD88 (SCVRS)
2. CONTOURS ARE SHOWN AT 1' INTERVALS

CAUTION

THE UTILITIES SHOWN ARE SHOWN FOR THE CONTRACTOR'S CONVENIENCE ONLY. THERE MAY BE OTHER UTILITIES NOT SHOWN ON THESE PLANS. THE SURVEYOR ASSUMES NO RESPONSIBILITY FOR THE LOCATIONS SHOWN AND IT SHALL BE THE CONTRACTOR'S RESPONSIBILITY TO VERIFY THE LOCATIONS OF ALL UTILITIES WITHIN THE LIMITS OF THE WORK. ALL DAMAGE MADE TO EXISTING UTILITIES BY THE CONTRACTOR SHALL BE THE SOLE RESPONSIBILITY OF THE CONTRACTOR.

LEGEND		
BH BUILDING HEIGHT	TC/BC TOP/BOTTOM CURB	GT GREASE TRAP MH
BL BUILDING LINE	TW/BW TOP/BOTTOM WALL	PIV POST VALVE INDICATOR
CL CENTERLINE	CO CLEAN OUT	UBP URP BOX
CMP CORRUGATED METAL PIPE	CB CATCH BASIN	Y YARD LIGHT
CT CURB TOP	DI DROP INLET	WELL
DE DRAINAGE EASEMENT	EL ELEC TRANS	GA GUY ANCHOR
EP EDGE OF PAVEMENT	EE ELEVATION	EM ELECTRIC METER
IPO IRON PIN OLD	FF FIRE HYDRANT	CTV CABLE TV
IPS IRON PIN SET	GM GAS METER	GS GAS
N&C NAIL & CAP	GV GAS VALVE	FL FENCE LINE
OT OPEN TOP	LP LIGHT POLE	FOC FIBER OPTIC CABLE
RB REBAR	OP OVERHEAD POWER	PR TEL-POWER POLE
ROP REINFORCED CONC PIPE	SMH MANHOLE (SD)	OHP OVERHEAD POWER
R/W RIGHT OF WAY	SMH MANHOLE (SS)	OHT OVERHEAD TELEPHONE
SD STORM DRAIN	TMH MANHOLE (TELEPHONE)	STD STORM DRAIN
SS SANITARY SEWER	TPED TELEPHONE PEDESTAL	SS SANITARY SEWER
SSE SE EASEMENT	W&C WATER METER	UTP UNDERGROUND POWER
VCP VITRIFIED CLAY PIPE	WQI WATER VALVE	UT UNDERGROUND TEL
		W WATER LINE

TOPOGRAPHIC SURVEY FOR
ACE 124-118 NE MAIN
GREENVILLE COUNTY, SOUTH CAROLINA

SCALE 1" = 30'	PROPERTY ADDRESS 124 & 118 NE MAIN STREET	TAX PIN 0315000200100 0315000200400
DATE 10/10/25	FIELD CREW VS/HL	DRAWN BY TBO

SITE DESIGN, INC.
CIVIL ENGINEERS - SURVEYORS - LANDSCAPE ARCHITECTS

225 ROCKY CREEK ROAD, GREENVILLE, SC 29615
PH: (864)271-0496
www.sitedesign-inc.com

TRAFFIC IMPACT STUDY

Burdette North Simpsonville, South Carolina

NOVEMBER 5, 2025

IMPACT DESIGNS, INC.

Prepared by: Allen J. Reid, PE

TRAFFIC IMPACT STUDY

Burdette North

SIMPSONVILLE, SOUTH CAROLINA

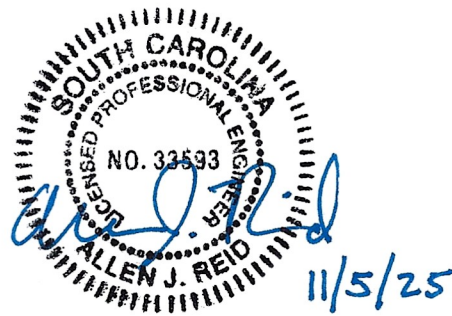

REPORT PREPARED FOR:
Alliance Consulting Engineers, Inc.
124 Verdae Boulevard, Suite 505
Greenville, SC 29607

REPORT PREPARED BY
Impact Designs Inc.
172 Williamson Road, Unit 3728
Mooresville, NC 28117
nick@impactdesignsinc.com

Table of Contents

- EXECUTIVE SUMMARY iii**
- 1. INTRODUCTION 1**
 - 1.1. Project Summary 1**
 - 1.2. Existing Roadway Conditions 1**
 - 1.3. Planned Roadway Improvements 2**
 - 1.4. Driveway Locations 2**
- 2. TRAFFIC VOLUME DEVELOPMENT 7**
 - 2.1. Existing Traffic Volumes 7**
 - 2.2. Rerouted Traffic Volumes 7**
 - 2.3. Projected Traffic Volumes 7**
 - 2.4. Proposed Development Traffic Volumes 8**
 - 2.5. Future Build Traffic Volumes 8**
- 3. TRAFFIC IMPACT ANALYSIS 16**
 - 3.1. Turn Lane Analysis 16**
 - 3.2. Intersection LOS Analysis 16**
- 4. SUMMARY OF FINDINGS 20**

Tables

Table 1 – Study Area Summary 1

Table 2 – Trip Generation..... 8

Table 3 – *HCM 6th Edition* LOS Criteria for Signalized & Unsignalized Intersections 16

Table 4 – Intersection Capacity Analysis Results..... 17

Figures

Figure 1 – Project Location..... 3

Figure 2 – Conceptual Site Plan..... 4

Figure 3 – Existing Lane Configuration 5

Figure 4 – No-Build Lane Configuration..... 6

Figure 5 – Raw Existing (2025) Traffic Volumes 9

Figure 6 – One-Way Volume Adjustments..... 10

Figure 7 – Adjusted Existing (2025) Traffic Volumes 11

Figure 8 – No-Build (2028) Traffic Volumes 12

Figure 9 – Site Trip Distribution..... 13

Figure 10 – Site Trip Assignments 14

Figure 11 – Build (2028) Traffic Volumes 15

Figure 12 – Recommended Lane Configuration..... 19

Appendices

- A) Traffic Count Data
- B) Turn Lane Analysis
- C) Synchro Analysis Reports
- D) SimTraffic Analysis Reports
- E) Background Improvements

EXECUTIVE SUMMARY

A traffic impact study was conducted for the proposed Burdette North development in accordance with SCDOT guidelines. The proposed development is located on the southeast corner of College Street and NE Main Street (SC 417), in Simpsonville, South Carolina. The development is expected to consist of 12,812 square feet of retail and up to 80 multi-family units and is anticipated to be constructed by the end of 2028. Direct access to Burdette North development is proposed to be provided via two full movement connections: one on Hedge Street and one on College Street. The development is expected to have parallel parking along Hedge Street, however, to be conservative all traffic was assumed to access the site through the site accesses.

A turn lane analysis was conducted at the site accesses utilizing the Build (2028) volumes. Based on build-out volumes, there are no turn lanes warranted at the site accesses.

The capacity analysis indicates that the signalized study intersections approaches are expected to maintain their LOS from No-Build to Build conditions, except for the northbound and southbound approach of NE Main Street (SC 417) and Curtis Street. Although, the approaches are expected to operate at LOS D or better in the Build scenario, which is still considered acceptable. Therefore, there is no mitigation recommended at the signalized intersections.

Additionally, the unsignalized study intersections are expected to operate at an LOS C or better in all scenarios. The site accesses are expected to operate at LOS B or better in the Build scenario. Therefore, there is no mitigation recommended at the study intersections based on the capacity analysis.

Recommendations:

- None

1. INTRODUCTION

The purpose of this report is to summarize the traffic impact study that was completed for the Burdette North site in Simpsonville, South Carolina. The study was developed in accordance with SCDOT guidelines. This report summarizes the procedures and findings of the traffic impact study.

1.1. Project Summary

The proposed development is located on the southeast corner of College Street and NE Main Street (SC 417), in Simpsonville, South Carolina. The development is expected to consist of 12,812 square feet of retail and up to 80 multi-family units and is anticipated to be constructed by the end of 2028. This traffic impact study analyzes the effects of the additional traffic associated with the proposed development during the weekday AM (7:00 AM - 9:00 AM) and the weekday PM (4:00 PM - 6:00 PM) peak periods. The study area for the purpose of the analysis includes:

- NE Main Street (SC 417) and College Street
- NE Main Street (SC 417) and Curtis Street
- Hedge Street and College Street
- Hedge Street and Curtis Street
- Main Street and College Street
- Main Street and Curtis Street
- Hedge Street and Access A
- College Street and Access B

The proposed development is expected to be built out by the end of 2028; therefore, 2028 was considered as the future year for the purpose of this analysis. Refer to Figures 1 and 2 for the site location and the conceptual site plan.

1.2. Existing Roadway Conditions

The primary roadways within the study area include NE Main Street (SC 417), Curtis Street and College Street. A summary of their existing characteristics is shown in Table 1.

Table 1 – Study Area Summary

Facility Name	Route #	Typical Cross Section	Posted Speed Limit	Maintained By	2024 AADT
College Street	N/A	2-lane undivided	25 MPH	Local	No Data
Curtis Street		2-lane undivided	25 MPH	SCDOT/Local	6,200
NE Main Street	SC 417	2-lane undivided	35 MPH	SCDOT	19,400

Refer to Figure 3 for an illustration of the existing geometry and traffic control at the study intersections.

1.3. Planned Roadway Improvements

The City of Simpsonville and SCDOT intend to construct a project to convert Curtis Street and College Street to a one-way pair with counterclockwise circulation. Based on the information provided by SCDOT and City staff, the following geometric improvements are proposed:

Curtis Street

- Convert the existing 2-lane road to a one-way two-lane road travelling eastbound.
- Adjust all intersections along Curtis Street to account for the approach restrictions.

College Street

- Convert the existing 2-lane road to a one-way two-lane road travelling westbound.
- Adjust all intersections along College Street to account for the approach restrictions.

College Street and NE Main Street (SC 417)

- Extend the northbound left turn lane to have 150 feet of storage.

Curtis Street and NE Main Street (SC 417)

- Extend the southbound left turn lane to have 225 feet of storage.



It was assumed that these projects would be completed prior to the build out of the Burdette North development. Refer to Figure 4 for an illustration of the background improvements. Refer to Appendix E for improvement plans and drawings.

1.4. Driveway Locations

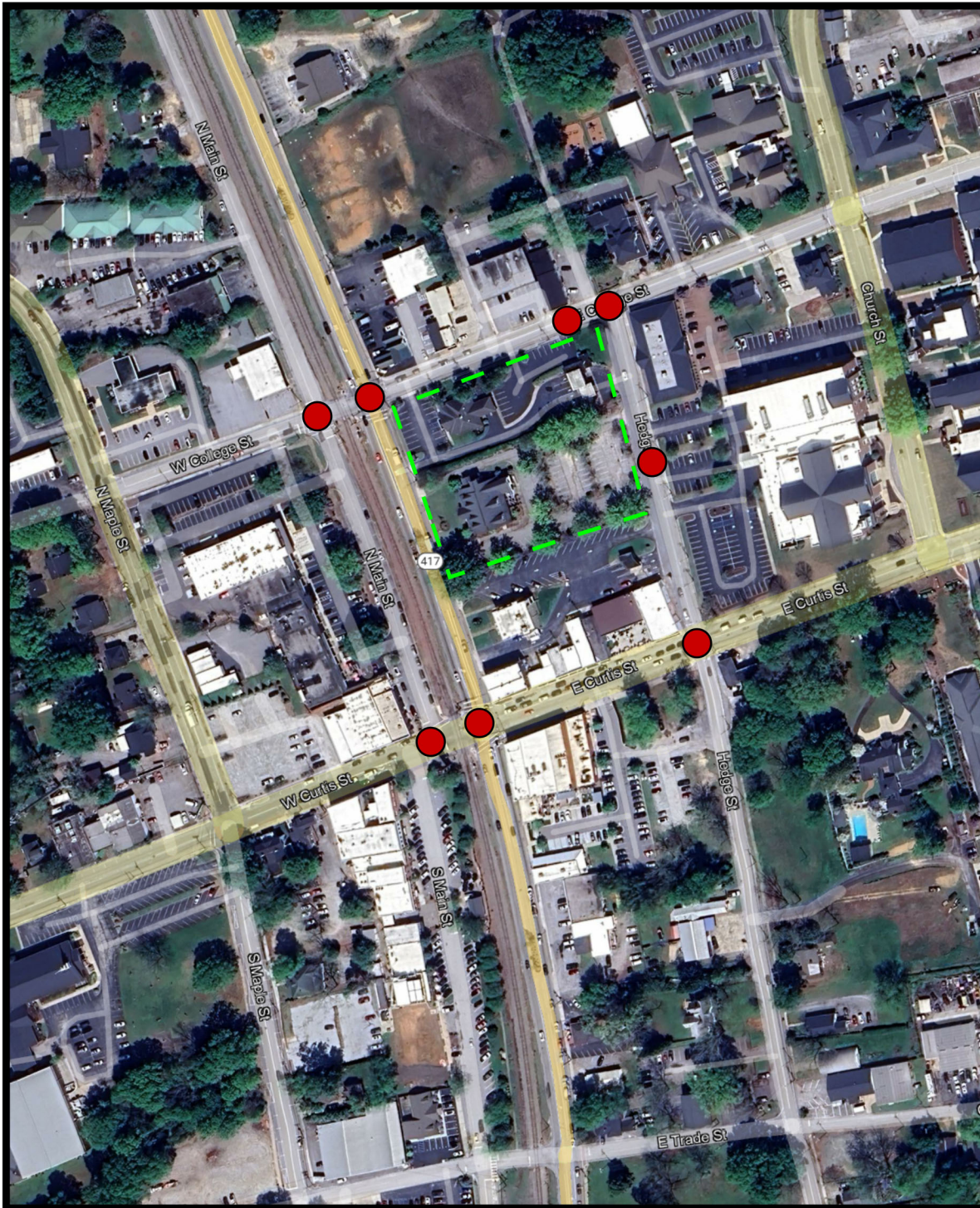
Direct access to Burdette North development is proposed to be provided via two full movement connections: one on Hedge Street and one on College Street. The development is expected to have parallel parking along Hedge Street, however, to be conservative all traffic was assumed to access the site through the site accesses.



LEGEND

-  Proposed Site Location
-  Study Intersections

IMPACT
 Designs, Inc.

*Burdette North
 Simpsonville, SC*

Site Location Map

Scale: Not to Scale	Figure	1
---------------------	--------	---



SITE INFORMATION:
 TM#: 0315000200100, 0315000200400
 SIZE: ±2.52 ACRES
 EXISTING ZONING: B-U (BUSINESS - URBAN)
 PROPOSED ZONING: ID (INNOVATIVE DEVELOPMENT)
 SETBACKS: -FRONT = NONE
 -SIDE = NONE
 -REAR = NONE
PARKING REQUIREMENTS:
 STALL WIDTH
 90-DEGREE STALL= 9-FT X 18FT 24-FT AISLE
 PROVIDED PARKING COUNT: 144 SPACES
 PASSENGER: 139 SPACES
 ADA: 5 SPACES
PROPOSED BUILDING:
 MIXED USE DEVELOPMENT
 3 STORIES

PROPOSED BUILDING INFORMATION:

	RESIDENTIAL	AMENITY	RETAIL	COMMERCIAL	TOTAL
LEVEL 1	13,994	6,147	8,991	3,823	32,955
LEVEL 2	32,955				32,955
LEVEL 3	32,955				32,955
TOTAL	79,904	6,147	8,991	3,823	98,865

RESIDENTIAL UNIT COUNT: 73

NOTE: BOUNDARIES, TOPOGRAPHY, WETLANDS, AND STREAMS LOCATIONS ARE APPROXIMATE BASED OFF GEOGRAPHIC INFORMATION SYSTEMS (GIS). A BOUNDARY AND TOPOGRAPHIC SURVEY ALONG WITH A WETLAND DELINEATION SHOULD BE PERFORMED TO DETERMINE ACCURATE BOUNDARY, TOPOGRAPHIC, AND WETLAND LOCATIONS.

Documents prepared or furnished by Alliance Consulting Engineers, Inc. are instruments of service, and Alliance Consulting Engineers, Inc. retains an ownership and property interest (including the copyright and the right of reuse) in such documents, whether or not the project is completed.

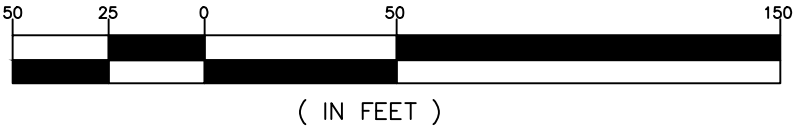

Project No.: 25195-0023
 October 9, 2025



±99,000-SF Mixed-Use Development
Located Along North East Main Street
City of Simpsonville
Greenville County, South Carolina

Blue Ridge Land Holdings, LLC



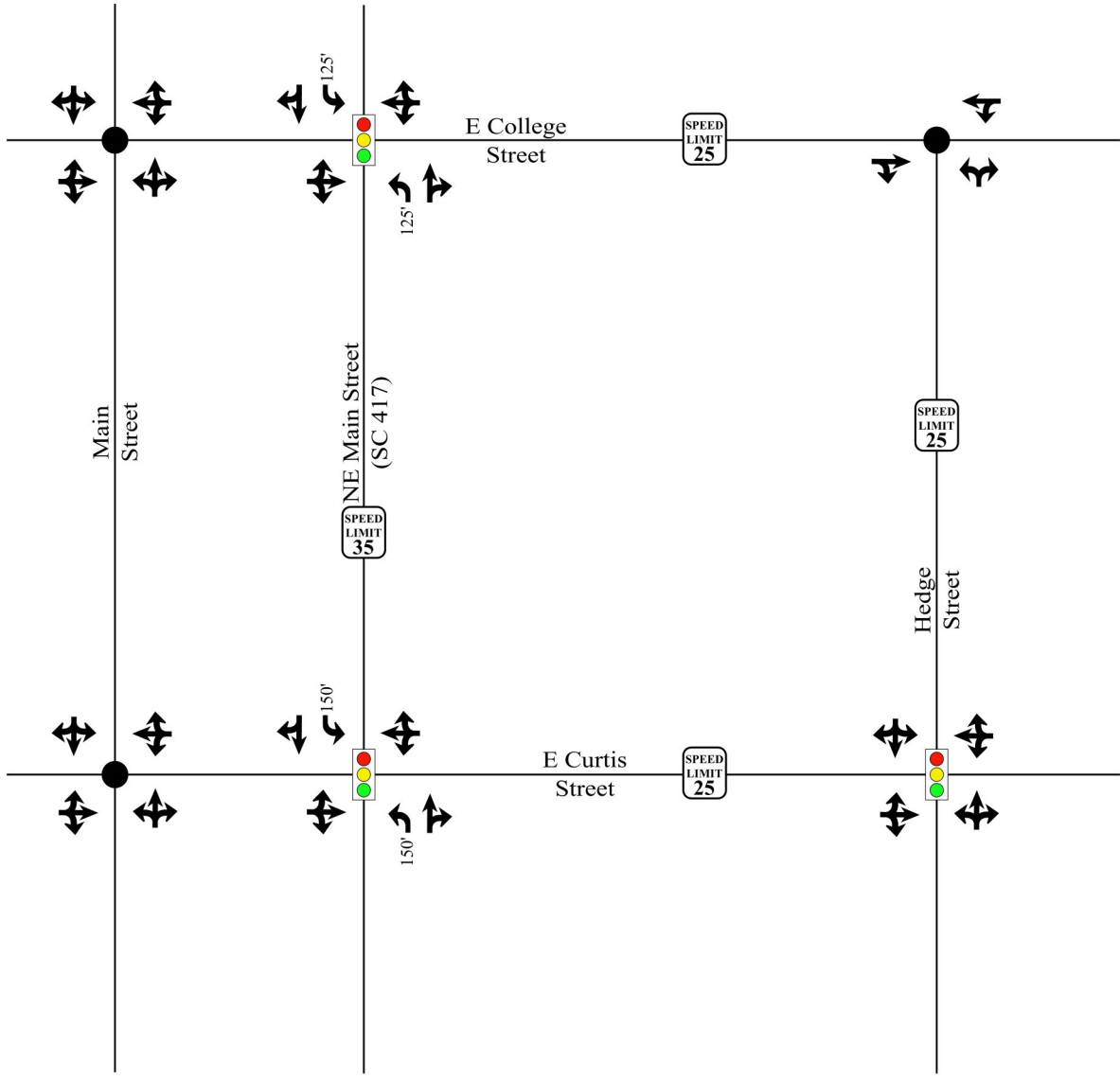

LEGEND

- Signalized Intersection
- Unsignalized Intersection
- Existing Lane
- X' Storage (In Feet)
- Posted Speed Limit

IMPACT
Designs, Inc.

*Burdette North
Simpsonville, SC*

Existing Lane Configurations
and Traffic Control

Scale: Not to Scale	Figure	3
---------------------	--------	---

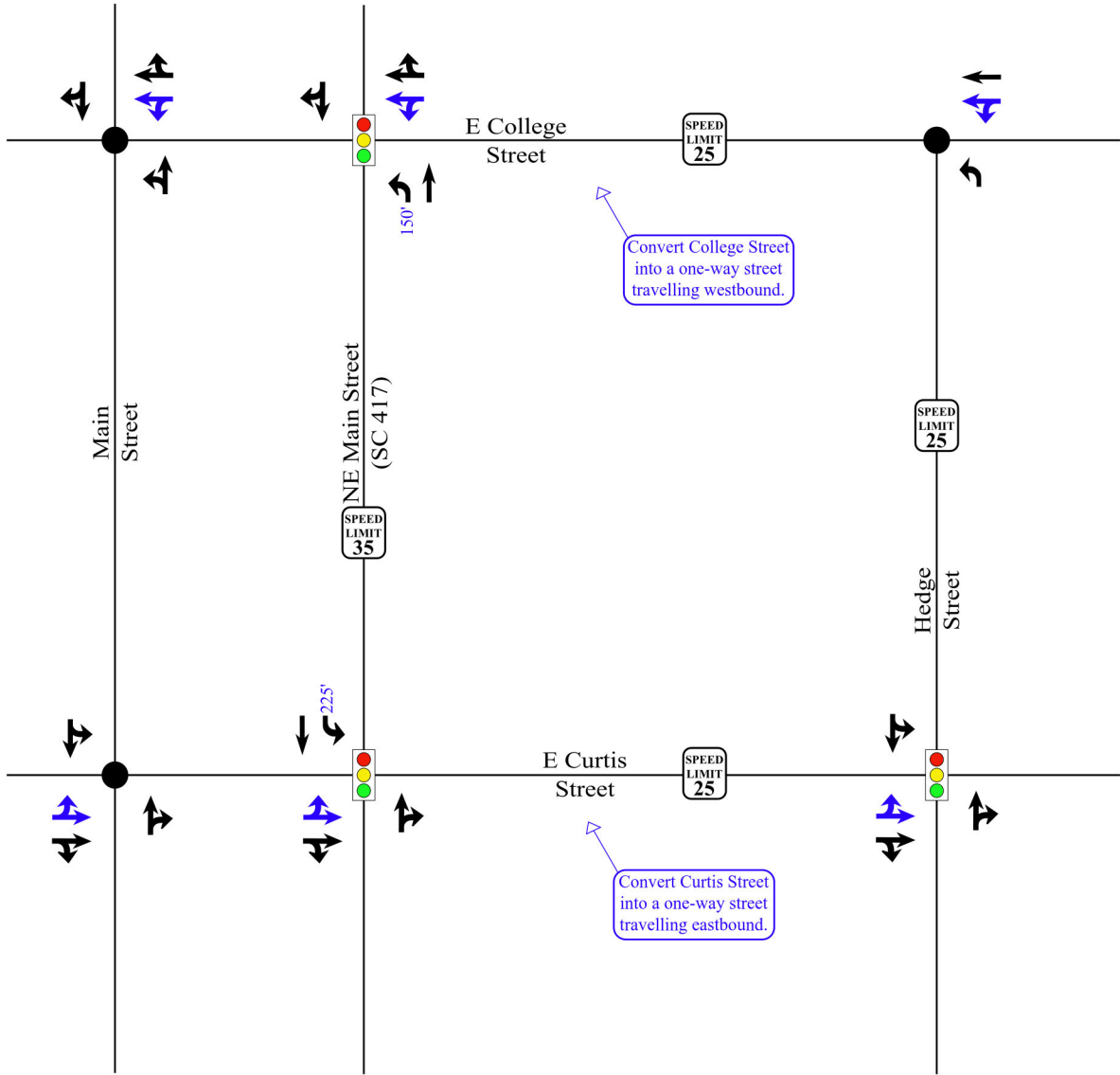

LEGEND

- Signalized Intersection
- Unsignalized Intersection
- Existing Lane
- Background Improvement
- X' Storage (In Feet)
- Posted Speed Limit

IMPACT
Designs, Inc.

*Burdette North
Simpsonville, SC*

No-Build Lane Configurations
and Traffic Control

Scale: Not to Scale	Figure	4
---------------------	--------	---

2. TRAFFIC VOLUME DEVELOPMENT

2.1. Existing Traffic Volumes

Existing turning movement counts were conducted at the study intersections in September 2025, during the AM (7:00 AM to 9:00 AM) peak period and the PM (4:00 PM to 6:00 PM) peak period. The 2025 traffic volumes are illustrated in Figure 5.

2.2. Rerouted Traffic Volumes

As previously mentioned, the City of Simpsonville and SCDOT intend to construct a project to convert Curtis Street and College Street to a one-way pair with counterclockwise circulation. Due to adjustment to the path of travel, it was assumed that eastbound traffic on College Street will become eastbound traffic on Curtis Street and westbound traffic on Curtis Street will become westbound traffic on College Street. Refer to Figure 6 and 7 for an illustration of the rerouted volumes on the study network.

2.3. Projected Traffic Volumes

Based on SCDOT Average Annual Daily Traffic (AADT) volumes, daily traffic volumes in the study area have grown at a rate of 2% in the past years. A 2% annual growth rate was applied to the 2025 rerouted volumes to develop the No-Build (2028) volumes. This growth rate was applied to account for all background growth in the area without any adjacent and/or the proposed developments. Refer to Figure 8 for an illustration of the No-Build (2028) traffic volumes at the study intersections.

2.4. Proposed Development Traffic Volumes

As mentioned previously, the proposed development is expected to consist of 12,812 square feet of retail and up to 80 multi-family units and is anticipated to be constructed by the end of 2028. The trip generation potential for the proposed development was estimated utilizing methodology contained within the ITE's *Trip Generation Manual*, 11th Edition. Utilizing ITE data for ITE Codes 220 and 822, traffic volumes were generated for the weekday daily, the weekday AM peak hour, and the weekday PM peak hour. Refer to Table 2 for a summary of the trip generation potential of the proposed development.

Table 2 – Trip Generation

ITE Land Use (Code)	Density	Independent Variable	Daily Traffic	AM Peak		PM Peak	
				Enter	Exit	Enter	Exit
Strip Retail Plaza (<40k) (ITE Code 822)	12.81	KSF	698	18	12	42	42
Multi-Family Housing (Low-Rise) (ITE Code 220)	80	Dwelling Units	588	11	37	35	20
Total New Trips			1,286	29	49	77	62

Traffic associated with the proposed development was distributed and assigned to the roadway network based upon existing travel patterns and are summarized below:

- 30% to/from the north via NE Main Street (SC 417)
- 15% to/from the south via NE Main Street (SC 417)
- 10% to/from the south via Hedge Street
- 25% to the east via Curtis Street
- 25% from the east via College Street
- 20% to the west via College Street
- 20% from the west via College Street

Refer to Figures 9 and 10 for the site trip distributions and assignments.

2.5. Future Build Traffic Volumes

The site generated traffic volumes were added to the No-Build (2028) traffic volumes to determine the Build (2028) volumes. The Build (2028) volumes are illustrated in Figure 11.

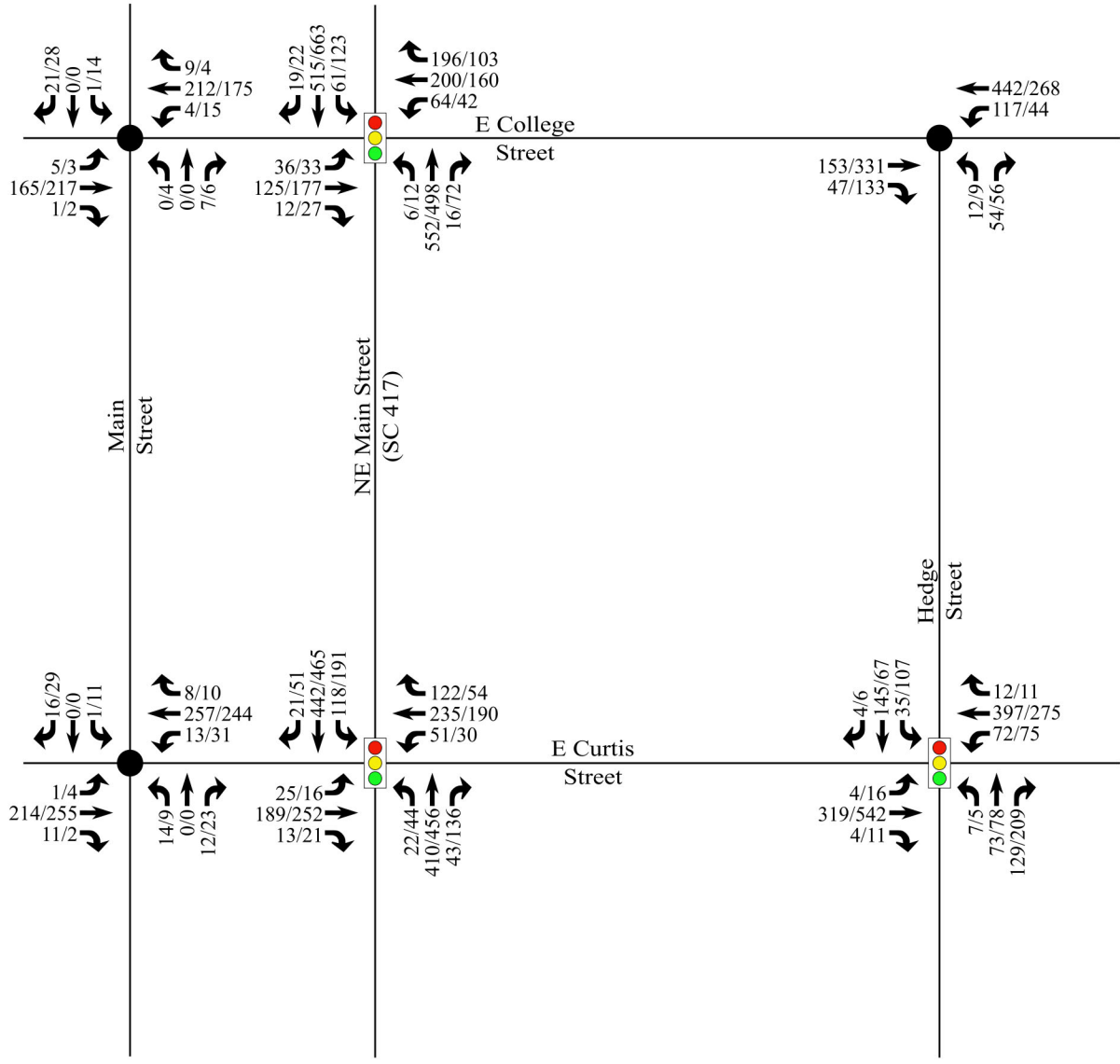

LEGEND	
	Signalized Intersection
	Unsignalized Intersection
X / Y →	AM / PM Peak Hour Traffic

IMPACT Designs, Inc.		
<i>Burdette North Simpsonville, SC</i>		
Raw Existing (2025) Traffic Volumes		
Scale: Not to Scale	Figure	5

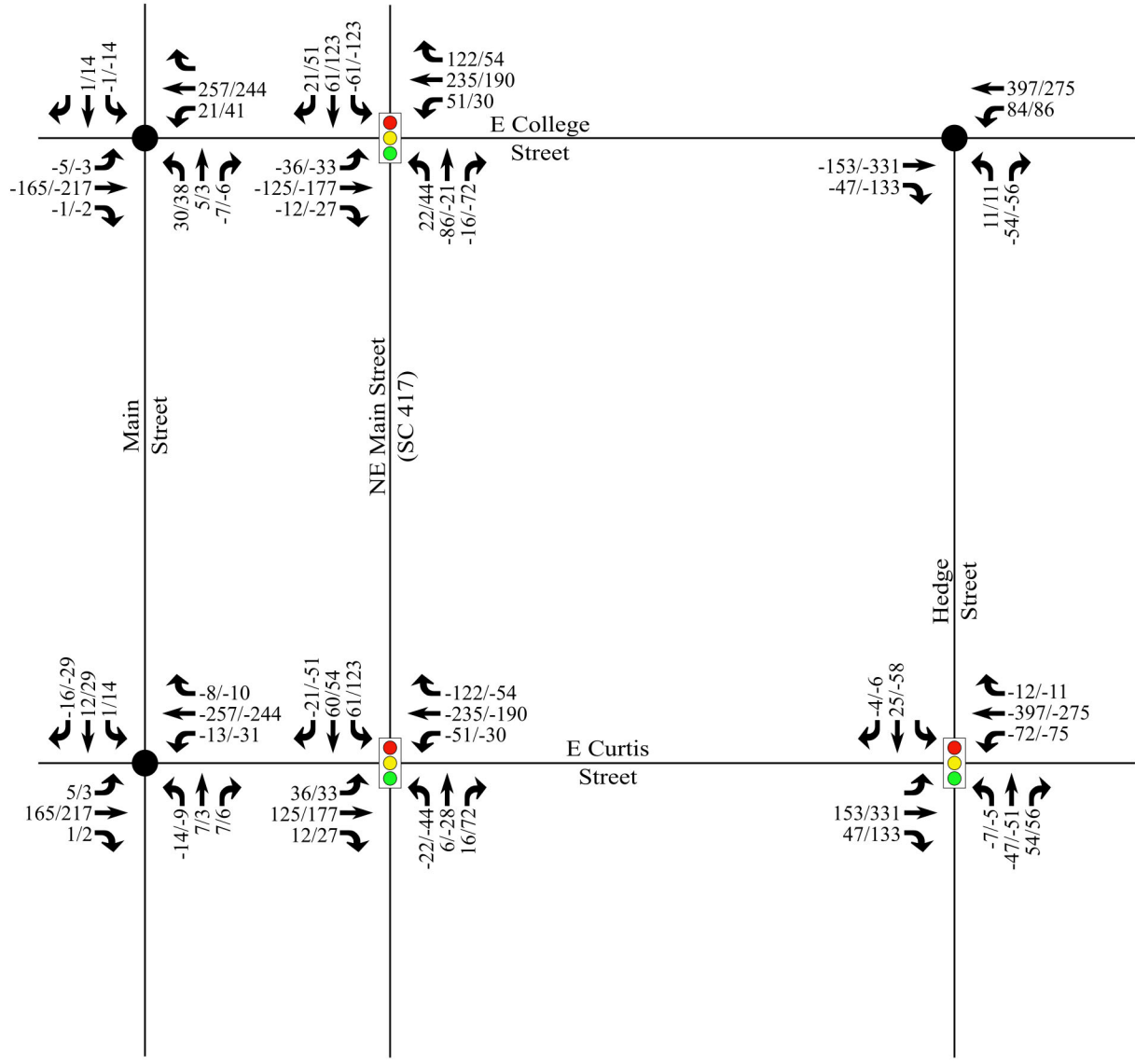

LEGEND

- Signalized Intersection
- Unsignalized Intersection
- X / Y → AM / PM Peak Hour Traffic

IMPACT
Designs, Inc.

*Burdette North
Simpsonville, SC*

**One-Way Volume
Adjustments**

Scale: Not to Scale	Figure	6
---------------------	--------	---

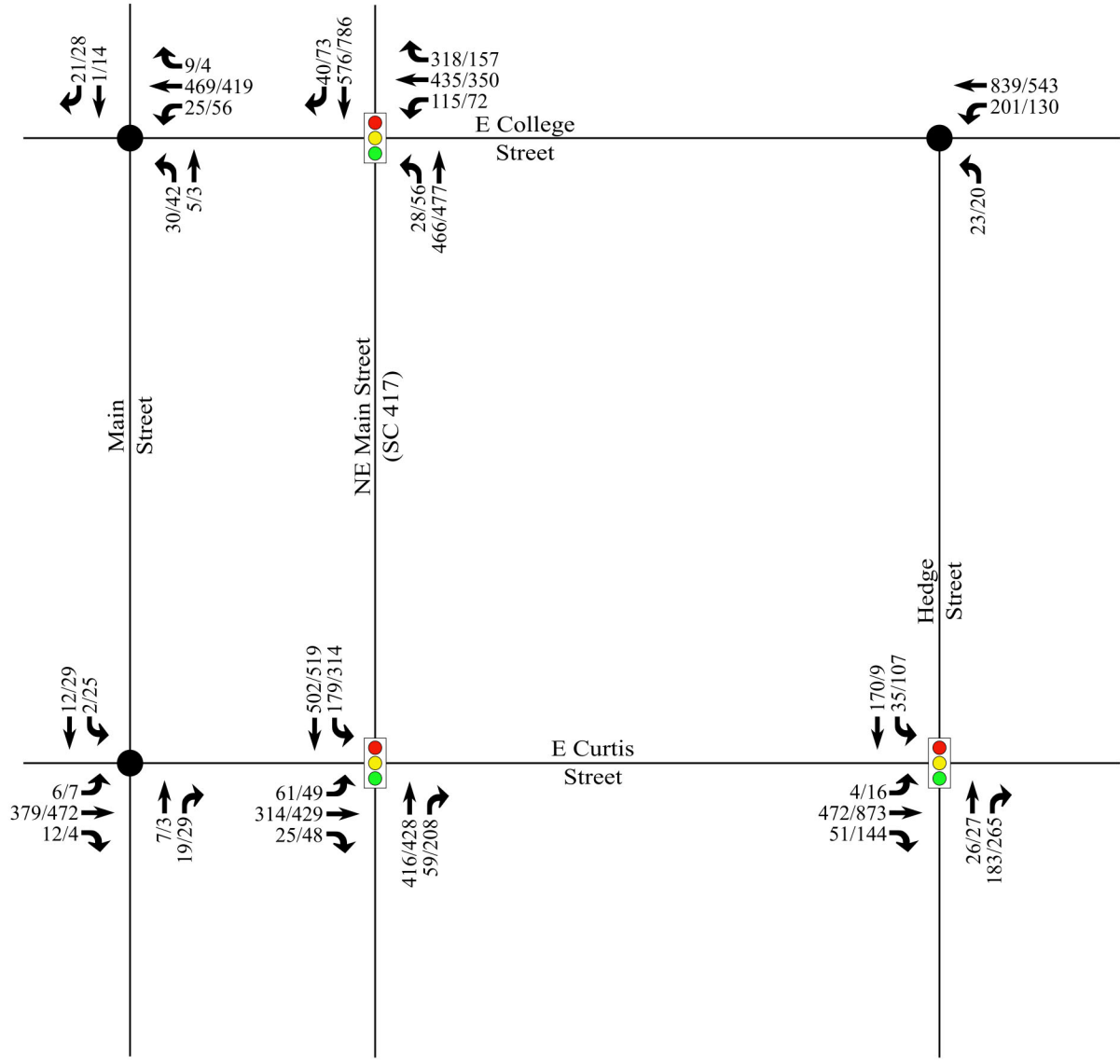

LEGEND

- Signalized Intersection
- Unsignalized Intersection
- X / Y → AM / PM Peak Hour Traffic

IMPACT
Designs, Inc.

*Burdette North
Simpsonville, SC*

Adjusted Existing (2025)
Traffic Volumes

Scale: Not to Scale	Figure	7
---------------------	--------	---

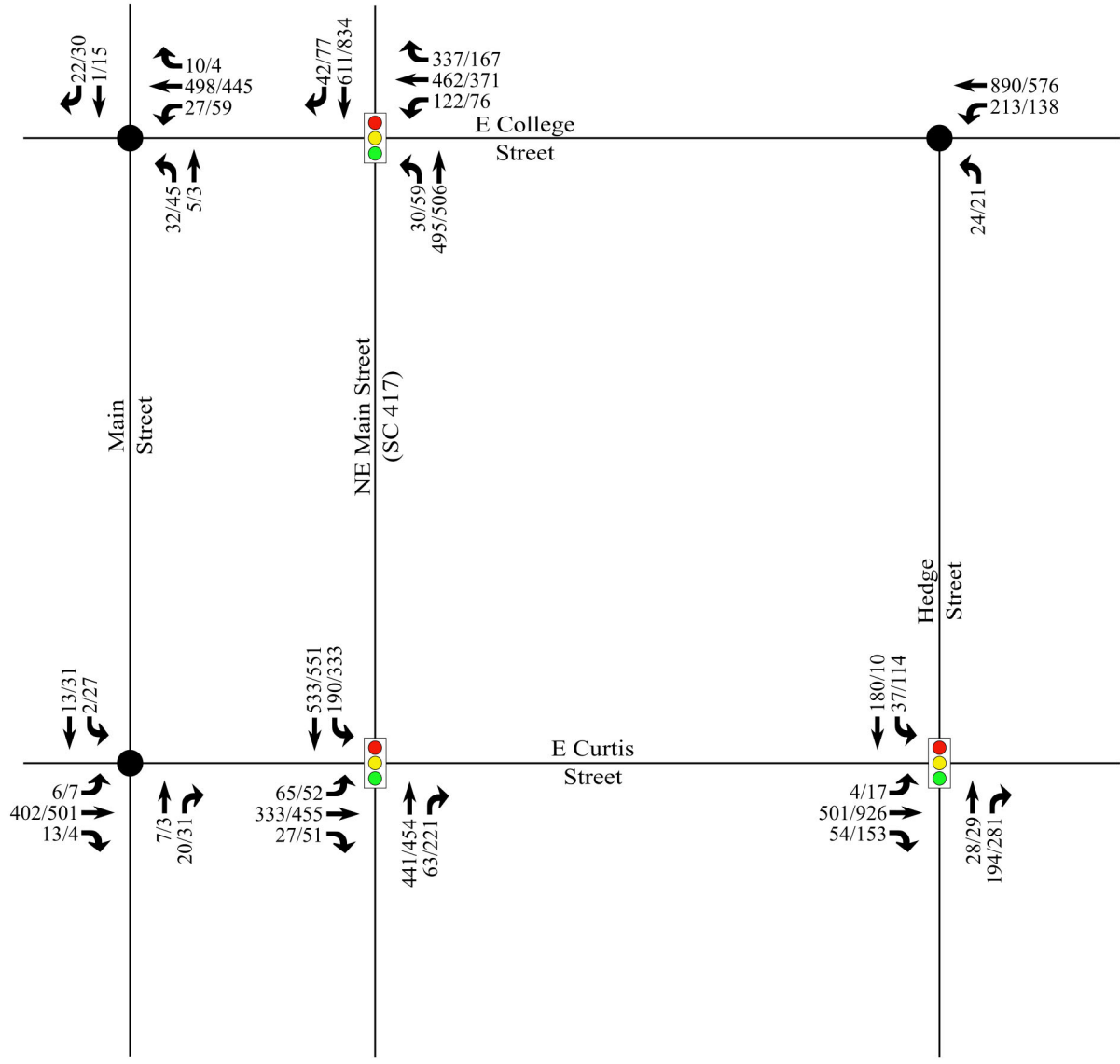

LEGEND

- Signalized Intersection
- Unsignalized Intersection
- X / Y → AM / PM Peak Hour Traffic

IMPACT

Designs, Inc.



Burdette North
Simpsonville, SC

No-Build (2028)
Traffic Volumes

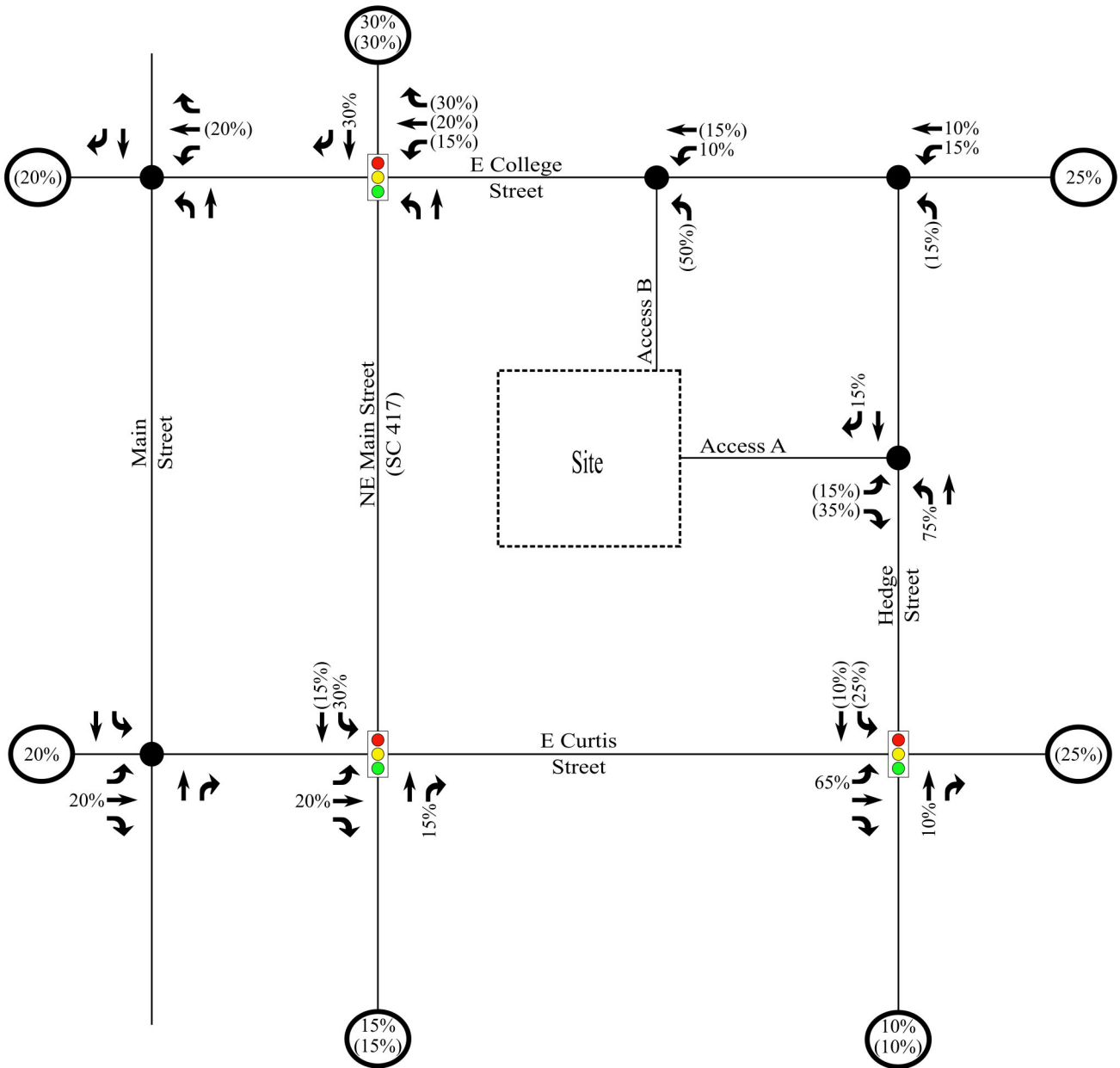
Scale: Not to Scale	Figure	8
---------------------	--------	---



LEGEND

-  Signalized Intersection
-  Unsignalized Intersection
- X% → Entering Trip Distribution
- (Y%) → Exiting Trip Distribution
-  Regional Trip Distribution

IMPACT
Designs, Inc.



*Burdette North
Simpsonville, SC*

Site Trip Distribution

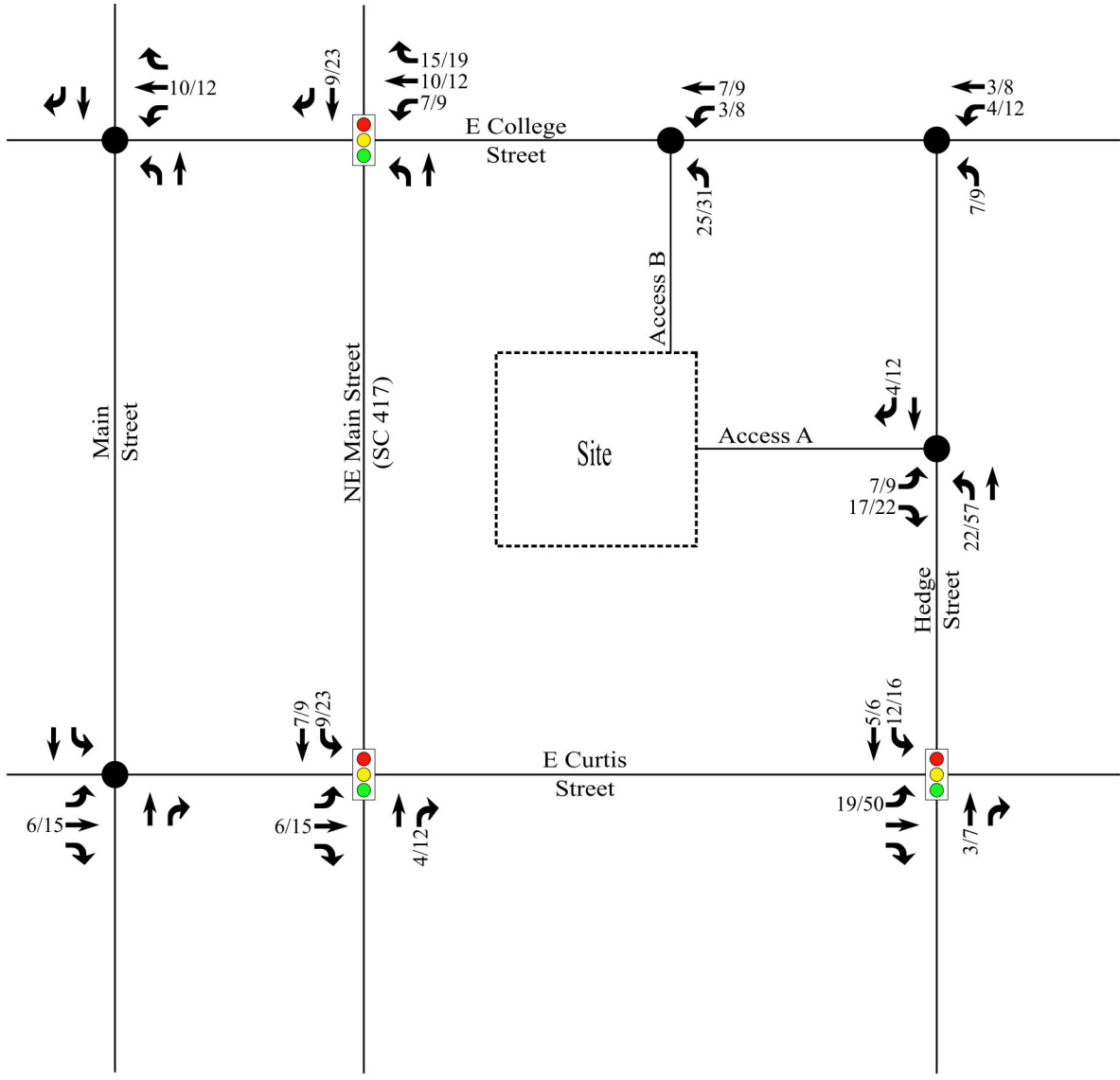
Scale: Not to Scale	Figure	9
---------------------	--------	---



LEGEND

 Signalized Intersection
 Unsignalized Intersection
 X/Y → AM / PM Site Trips

IMPACT Designs, Inc.		
<i>Burdette North Simpsonville, SC</i>		
Trip Assignments		
Scale: Not to Scale	Figure	10

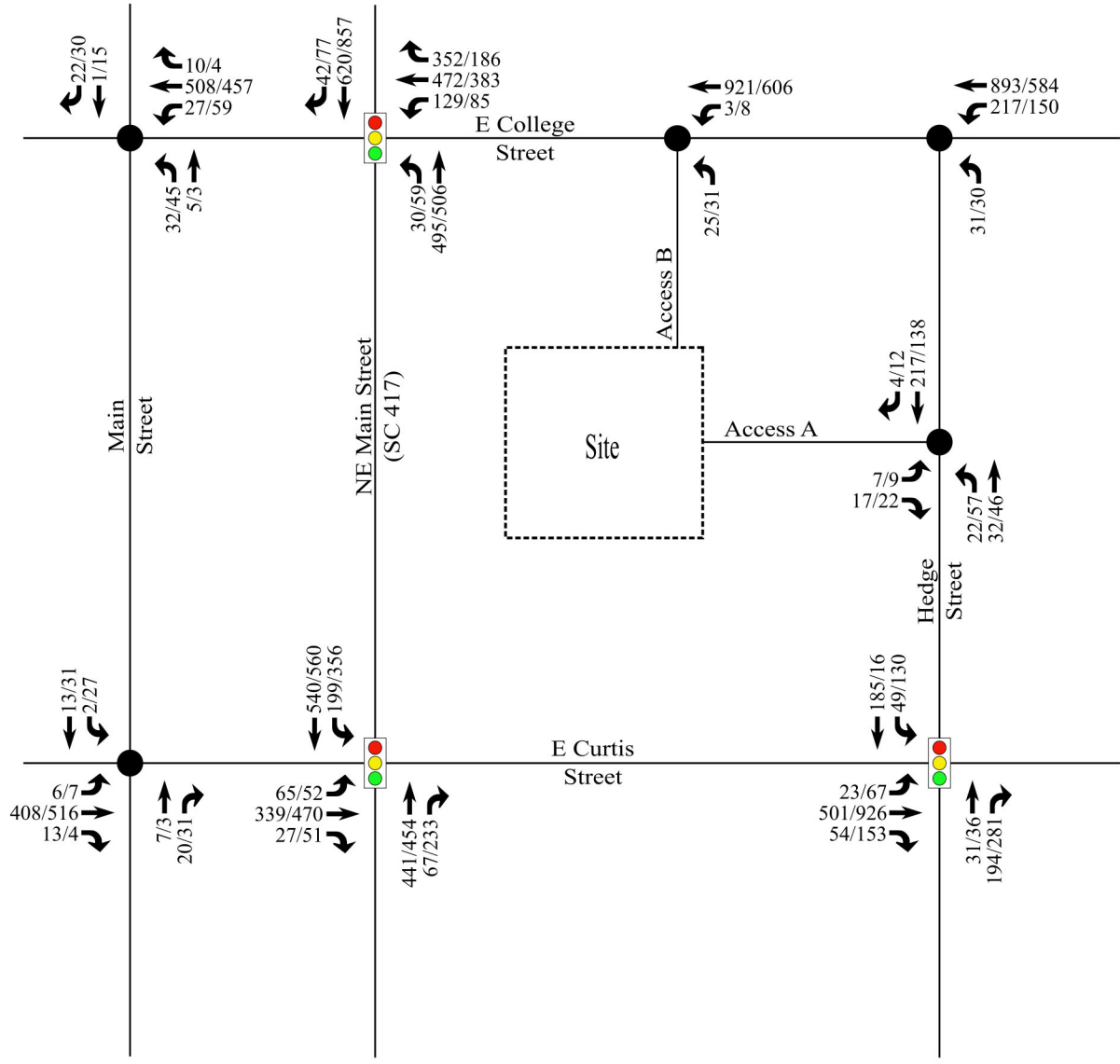
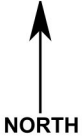

LEGEND

- Signalized Intersection
- Unsignalized Intersection
- X / Y → AM / PM Peak Hour Traffic

IMPACT
Designs, Inc.

*Burdette North
Simpsonville, SC*

Build (2028)
Traffic Volumes

Scale: Not to Scale	Figure	11
---------------------	--------	----

3. TRAFFIC IMPACT ANALYSIS

3.1. Turn Lane Analysis

A turn lane analysis was conducted at the site accesses utilizing the Build (2028) volumes. Based on build-out volumes, there are no turn lanes warranted at the site accesses.

Refer to Appendix B for the turn lane warrants with the volumes graphed.

3.2. Intersection LOS Analysis

Using the existing, no-build, and build traffic volumes, intersection analyses were conducted for the study intersections under Existing (2025) conditions, No-Build (2028) conditions and Build (2028) conditions. This analysis was conducted using the Transportation Research Board's *Highway Capacity Manual (HCM 6th Edition)* methodologies of the *Synchro*, Version 11 software.

Intersection level of service (LOS) grades range from LOS A to LOS F, which are directly related to the level of control delay at the intersection and characterize the operational conditions of the intersection traffic flow. LOS A operations typically represent ideal, free-flow conditions where vehicles experience little to no delays, and LOS F operations typically represent poor, forced-flow (bumper-to-bumper) conditions with high vehicular delays, and are generally considered undesirable. Table 3 summarizes the *HCM 6th Edition* control delay thresholds associated with each LOS grade for signalized and unsignalized intersections.

Table 3 – HCM 6th Edition LOS Criteria for Signalized & Unsignalized Intersections

Signalized Intersections		Unsignalized Intersections	
LOS	Control Delay per Vehicle (seconds)	LOS	Control Delay per Vehicle (seconds)
A	≤ 10	A	≤ 10
B	> 10 and ≤ 20	B	> 10 and ≤ 15
C	> 20 and ≤ 35	C	> 15 and ≤ 25
D	> 35 and ≤ 55	D	> 25 and ≤ 35
E	> 55 and ≤ 80	E	> 35 and ≤ 50
F	> 85	F	> 50

The results of the capacity analysis for the study intersections under existing traffic control are summarized in Table 4. Refer to Appendix C for the detailed capacity analysis reports and Appendix D for the queuing analysis results.

Table 4 – Intersection Capacity Analysis Results

Intersections	Approach	LOS (Delay in seconds per vehicle)					
		Existing (2025)		No-Build (2028)		Build (2028)	
		AM	PM	AM	PM	AM	PM
NE Main Street (SC 417) & College Street	EB	C (26.0)	D (45.0)	<i>Analyzed under Existing conditions only</i>			
	WB	D (45.5)	E (56.8)	D (38.0)	D (48.6)	D (39.8)	D (52.9)
	NB	B (18.5)	A (9.8)	A (4.0)	A (3.0)	A (4.1)	A (3.6)
	SB	B (19.3)	B (14.2)	C (25.8)	C (30.5)	C (26.5)	C (34.0)
	Overall	C (26.4)	C (23.4)	C (25.7)	C (28.4)	C (26.9)	C (31.8)
NE Main Street (SC 417) & Curtis Street	EB	C (30.0)	D (54.0)	D (43.9)	D (54.0)	D (44.0)	D (54.9)
	WB	C (29.5)	D (46.8)	<i>Analyzed under Existing conditions only</i>			
	NB	C (23.5)	C (20.4)	B (18.2)	C (34.1)	B (18.4)	D (36.3)
	SB	A (6.8)	B (10.6)	A (2.5)	A (9.1)	A (2.6)	B (13.0)
	Overall	C (20.1)	C (25.6)	B (18.0)	C (28.9)	B (18.0)	C (31.4)
Hedge Street & College Street	EB	-	-	<i>Analyzed under Existing conditions only</i>			
	WB	A (8.0)	A (8.6)	-	-	-	-
	NB	B (12.0)	B (12.6)	C (21.0)	B (14.2)	C (21.8)	B (14.9)
Hedge Street & Curtis Street	EB	A (8.8)	B (17.2)	A (6.9)	B (10.2)	A (7.6)	B (11.2)
	WB	B (19.1)	B (19.8)	<i>Analyzed under Existing conditions only</i>			
	NB	D (42.7)	D (44.6)	B (19.6)	D (38.3)	B (19.9)	D (41.1)
	SB	D (50.8)	D (51.3)	D (49.8)	D (51.2)	D (49.5)	D (52.4)
	Overall	C (25.3)	C (27.9)	B (19.0)	B (19.2)	B (19.7)	C (20.8)
Main Street & College Street	EB	A (7.7)	A (7.6)	<i>Analyzed under Existing conditions only</i>			
	WB	A (7.6)	A (7.8)	-	-	-	-
	NB	A (9.2)	B (10.9)	B (12.2)	B (13.1)	B (12.3)	B (13.2)
	SB	A (9.8)	B (10.7)	B (10.4)	B (11.8)	B (10.5)	B (11.9)
Main Street & Curtis Street	EB	A (7.8)	A (7.8)	-	-	-	-
	WB	A (7.8)	A (7.9)	<i>Analyzed under Existing conditions only</i>			
	NB	B (12.2)	B (11.7)	B (10.6)	B (10.6)	B (10.6)	B (10.7)
	SB	B (10.2)	B (11.7)	B (12.4)	B (13.4)	B (12.4)	B (13.6)
Hedge Street & Access A	EB	<i>Analyzed under Build conditions only</i>				B (10.0)	A (9.8)
	NB					A (7.8)	A (7.7)
	SB					-	-
College Street & Access B	WB	<i>Analyzed under Build conditions only</i>				-	-
	NB					B (12.8)	B (11.2)



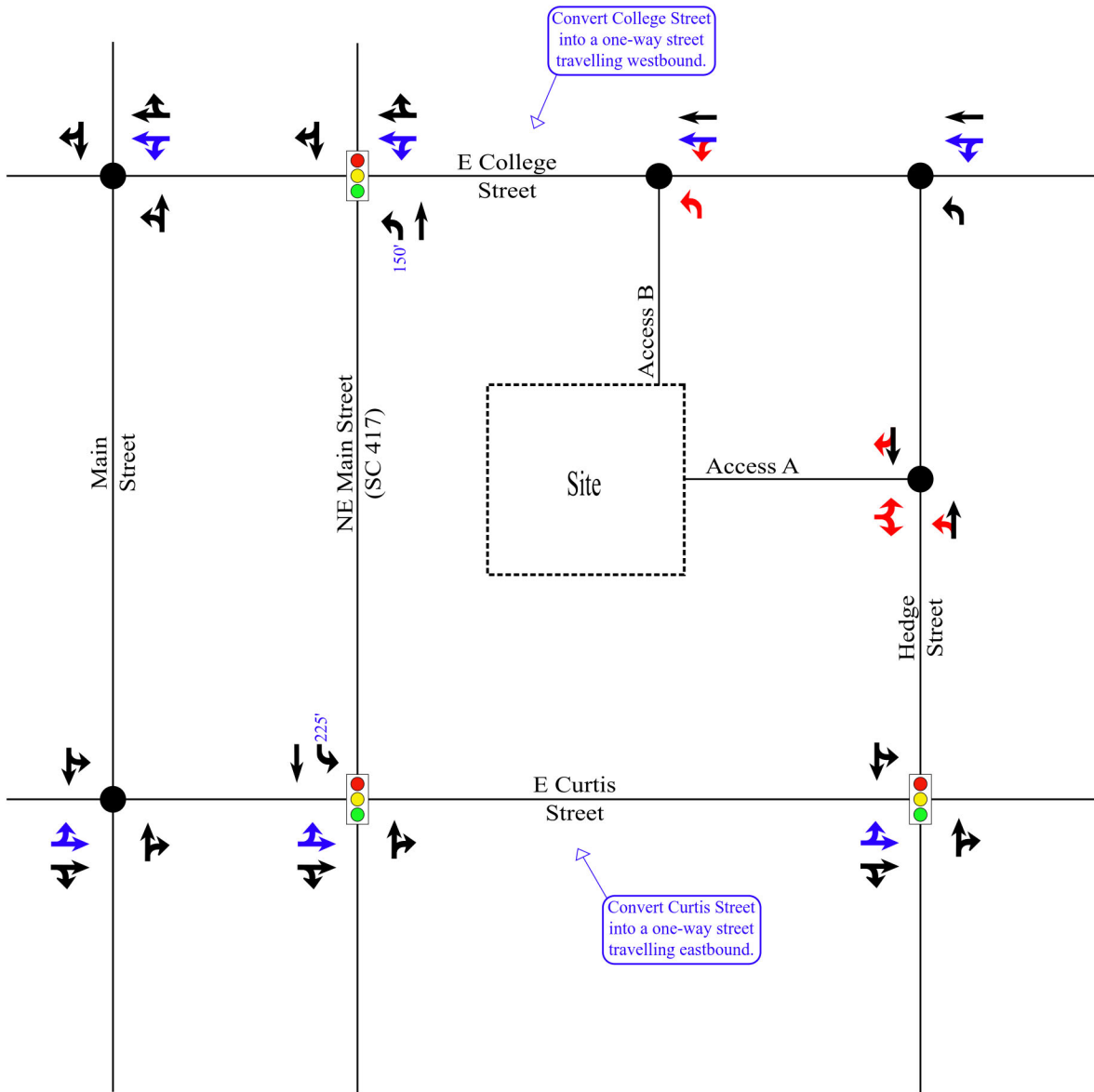

The capacity analysis indicates that the signalized study intersections approaches are expected to maintain their LOS from No-Build to Build conditions, except for the northbound and southbound approach of NE Main Street (SC 417) and Curtis Street. Although, the approaches are expected to operate at LOS D or better in the Build scenario, which is still considered acceptable. Therefore, there is no mitigation recommended at the signalized intersections.

Additionally, the unsignalized study intersections are expected to operate at an LOS C or better in all scenarios. The site accesses are expected to operate at LOS B or better in the Build scenario. Therefore, there is no mitigation recommended at the study intersections based on the capacity analysis.

Figure 12 shows the proposed lane configurations and traffic control for the Build (2028) conditions.



LEGEND

-  Signalized Intersection
-  Unsignalized Intersection
-  Existing Lane
-  Recommended Improvement
-  Background Improvement
- X' Storage (In Feet)

IMPACT

Designs, Inc.

*Burdette North
Simpsonville, SC*

Proposed Lane Configurations
and Traffic Control

Scale: Not to Scale

Figure

12

4. SUMMARY OF FINDINGS

A traffic impact study was conducted for the proposed Burdette North development in accordance with SCDOT guidelines. The proposed development is located on the southeast corner of College Street and NE Main Street (SC 417), in Simpsonville, South Carolina. The development is expected to consist of 12,812 square feet of retail and up to 80 multi-family units and is anticipated to be constructed by the end of 2028. Direct access to Burdette North development is proposed to be provided via two full movement connections: one on Hedge Street and one on College Street. The development is expected to have parallel parking along Hedge Street, however, to be conservative all traffic was assumed to access the site through the site accesses.

A turn lane analysis was conducted at the site accesses utilizing the Build (2028) volumes. Based on build-out volumes, there are no turn lanes warranted at the site accesses.

The capacity analysis indicates that the signalized study intersections approaches are expected to maintain their LOS from No-Build to Build conditions, except for the northbound and southbound approach of NE Main Street (SC 417) and Curtis Street. Although, the approaches are expected to operate at LOS D or better in the Build scenario, which is still considered acceptable. Therefore, there is no mitigation recommended at the signalized intersections.

Additionally, the unsignalized study intersections are expected to operate at an LOS C or better in all scenarios. The site accesses are expected to operate at LOS B or better in the Build scenario. Therefore, there is no mitigation recommended at the study intersections based on the capacity analysis.

Recommendations:

- None

TECHNICAL APPENDIX

APPENDIX A

TRAFFIC COUNT DATA



TRAFFIC DATA COLLECTION

File Name : Simpsonville(01 - SC 417 and College Street)
 Site Code :
 Start Date : 9/24/2025
 Page No : 1

Groups Printed- Cars + - Trucks

Start Time	SC 417 Southbound					College Street Westbound					SC 417 Northbound					College Street Eastbound					Int. Total
	Left	Thru	Right	Peds	App. Total	Left	Thru	Right	Peds	App. Total	Left	Thru	Right	Peds	App. Total	Left	Thru	Right	Peds	App. Total	
07:00 AM	7	71	2	0	80	18	41	61	0	120	0	87	6	1	94	1	16	1	1	19	313
07:15 AM	12	80	2	0	94	17	37	68	1	123	2	126	4	0	132	4	28	1	4	37	386
07:30 AM	14	124	5	0	143	13	60	56	0	129	1	139	2	1	143	10	31	1	2	44	459
07:45 AM	14	121	4	0	139	15	54	50	0	119	2	154	2	0	158	15	29	1	1	46	462
Total	47	396	13	0	456	63	192	235	1	491	5	506	14	2	527	30	104	4	8	146	1620
08:00 AM	17	137	3	0	157	19	54	44	0	117	1	126	6	0	133	8	33	4	2	47	454
08:15 AM	16	133	7	0	156	17	32	46	0	95	2	133	6	0	141	3	32	6	1	42	434
08:30 AM	13	101	3	0	117	10	41	40	0	91	3	125	6	0	134	8	27	2	0	37	379
08:45 AM	18	102	4	0	124	8	40	41	0	89	2	118	4	0	124	15	27	2	0	44	381
Total	64	473	17	0	554	54	167	171	0	392	8	502	22	0	532	34	119	14	3	170	1648
Grand Total	111	869	30	0	1010	117	359	406	1	883	13	1008	36	2	1059	64	223	18	11	316	3268
Apprch %	11	86	3	0		13.3	40.7	46	0.1		1.2	95.2	3.4	0.2		20.3	70.6	5.7	3.5		
Total %	3.4	26.6	0.9	0	30.9	3.6	11	12.4	0	27	0.4	30.8	1.1	0.1	32.4	2	6.8	0.6	0.3	9.7	
Cars +	110	846	28	0	984	114	355	405	1	875	13	988	35	2	1038	63	218	18	11	310	3207
% Cars +	99.1	97.4	93.3	0	97.4	97.4	98.9	99.8	100	99.1	100	98	97.2	100	98	98.4	97.8	100	100	98.1	98.1
Trucks	1	23	2	0	26	3	4	1	0	8	0	20	1	0	21	1	5	0	0	6	61
% Trucks	0.9	2.6	6.7	0	2.6	2.6	1.1	0.2	0	0.9	0	2	2.8	0	2	1.6	2.2	0	0	1.9	1.9



TRAFFIC DATA COLLECTION

File Name : Simpsonville(01 - SC 417 and College Street)
 Site Code :
 Start Date : 9/24/2025
 Page No : 2

Start Time	SC 417 Southbound					College Street Westbound					SC 417 Northbound					College Street Eastbound					Int. Total
	Left	Thru	Right	Peds	App. Total	Left	Thru	Right	Peds	App. Total	Left	Thru	Right	Peds	App. Total	Left	Thru	Right	Peds	App. Total	
Peak Hour Analysis From 07:00 AM to 08:45 AM - Peak 1 of 1																					
Peak Hour for Entire Intersection Begins at 07:30 AM																					
07:30 AM	14	124	5	0	143	13	60	56	0	129	1	139	2	1	143	10	31	1	2	44	459
07:45 AM	14	121	4	0	139	15	54	50	0	119	2	154	2	0	158	15	29	1	1	46	462
08:00 AM	17	137	3	0	157	19	54	44	0	117	1	126	6	0	133	8	33	4	2	47	454
08:15 AM	16	133	7	0	156	17	32	46	0	95	2	133	6	0	141	3	32	6	1	42	434
Total Volume	61	515	19	0	595	64	200	196	0	460	6	552	16	1	575	36	125	12	6	179	1809
% App. Total	10.3	86.6	3.2	0		13.9	43.5	42.6	0		1	96	2.8	0.2		20.1	69.8	6.7	3.4		
PHF	.897	.940	.679	.000	.947	.842	.833	.875	.000	.891	.750	.896	.667	.250	.910	.600	.947	.500	.750	.952	.979
Cars + Trucks	61	498	17	0	576	62	198	195	0	455	6	541	16	1	564	36	122	12	6	176	1771
% Cars + Trucks	100	96.7	89.5	0	96.8	96.9	99.0	99.5	0	98.9	100	98.0	100	100	98.1	100	97.6	100	100	98.3	97.9
% Trucks	0	17	2	0	19	2	2	1	0	5	0	11	0	0	11	0	3	0	0	3	38
% Trucks	0	3.3	10.5	0	3.2	3.1	1.0	0.5	0	1.1	0	2.0	0	0	1.9	0	2.4	0	0	1.7	2.1

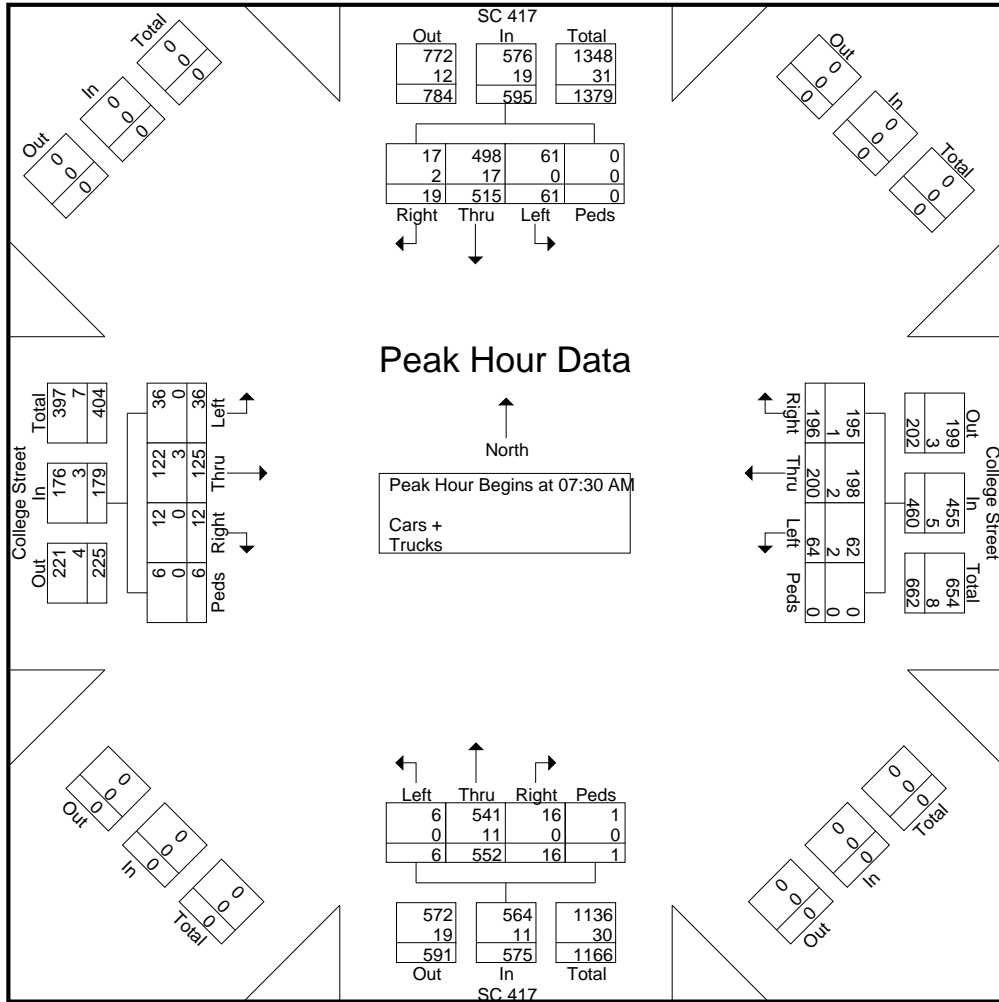



TRAFFIC DATA COLLECTION

File Name : Simpsonville(01 - SC 417 and College Street)
 Site Code :
 Start Date : 9/24/2025
 Page No : 1

Groups Printed- Cars + - Trucks

Start Time	SC 417 Southbound					College Street Westbound					SC 417 Northbound					College Street Eastbound					Int. Total
	Left	Thru	Right	Peds	App. Total	Left	Thru	Right	Peds	App. Total	Left	Thru	Right	Peds	App. Total	Left	Thru	Right	Peds	App. Total	
04:00 PM	43	174	4	0	221	6	31	34	0	71	4	140	18	0	162	2	42	8	0	52	506
04:15 PM	30	155	7	0	192	11	44	25	0	80	3	129	22	0	154	8	43	9	0	60	486
04:30 PM	24	178	6	0	208	7	36	26	0	69	1	120	11	0	132	7	51	9	0	67	476
04:45 PM	32	145	5	0	182	12	37	28	1	78	3	123	20	0	146	8	42	7	0	57	463
Total	129	652	22	0	803	36	148	113	1	298	11	512	71	0	594	25	178	33	0	236	1931
05:00 PM	37	185	4	0	226	12	43	24	0	79	5	126	19	0	150	10	41	2	0	53	508
05:15 PM	38	146	3	2	189	6	38	23	1	68	2	110	16	0	128	4	51	10	0	65	450
05:30 PM	49	167	7	0	223	10	46	20	0	76	2	97	19	0	118	4	49	10	0	63	480
05:45 PM	53	153	5	0	211	11	31	16	0	58	5	114	24	0	143	2	67	6	0	75	487
Total	177	651	19	2	849	39	158	83	1	281	14	447	78	0	539	20	208	28	0	256	1925
Grand Total	306	1303	41	2	1652	75	306	196	2	579	25	959	149	0	1133	45	386	61	0	492	3856
Apprch %	18.5	78.9	2.5	0.1		13	52.8	33.9	0.3		2.2	84.6	13.2	0		9.1	78.5	12.4	0		
Total %	7.9	33.8	1.1	0.1	42.8	1.9	7.9	5.1	0.1	15	0.6	24.9	3.9	0	29.4	1.2	10	1.6	0	12.8	
Cars +	306	1296	41	2	1645	74	304	195	2	575	25	949	147	0	1121	45	386	60	0	491	3832
% Cars +	100	99.5	100	100	99.6	98.7	99.3	99.5	100	99.3	100	99	98.7	0	98.9	100	100	98.4	0	99.8	99.4
Trucks	0	7	0	0	7	1	2	1	0	4	0	10	2	0	12	0	0	1	0	1	24
% Trucks	0	0.5	0	0	0.4	1.3	0.7	0.5	0	0.7	0	1	1.3	0	1.1	0	0	1.6	0	0.2	0.6



TRAFFIC DATA COLLECTION

File Name : Simpsonville(01 - SC 417 and College Street)
 Site Code :
 Start Date : 9/24/2025
 Page No : 2

Start Time	SC 417 Southbound					College Street Westbound					SC 417 Northbound					College Street Eastbound					Int. Total
	Left	Thru	Right	Peds	App. Total	Left	Thru	Right	Peds	App. Total	Left	Thru	Right	Peds	App. Total	Left	Thru	Right	Peds	App. Total	
Peak Hour Analysis From 04:00 PM to 05:45 PM - Peak 1 of 1																					
Peak Hour for Entire Intersection Begins at 04:15 PM																					
04:15 PM	30	155	7	0	192	11	44	25	0	80	3	129	22	0	154	8	43	9	0	60	486
04:30 PM	24	178	6	0	208	7	36	26	0	69	1	120	11	0	132	7	51	9	0	67	476
04:45 PM	32	145	5	0	182	12	37	28	1	78	3	123	20	0	146	8	42	7	0	57	463
05:00 PM	37	185	4	0	226	12	43	24	0	79	5	126	19	0	150	10	41	2	0	53	508
Total Volume	123	663	22	0	808	42	160	103	1	306	12	498	72	0	582	33	177	27	0	237	1933
% App. Total	15.2	82.1	2.7	0		13.7	52.3	33.7	0.3		2.1	85.6	12.4	0		13.9	74.7	11.4	0		
PHF	.831	.896	.786	.000	.894	.875	.909	.920	.250	.956	.600	.965	.818	.000	.945	.825	.868	.750	.000	.884	.951
Cars + Trucks	123	659	22	0	804	41	160	103	1	305	12	493	72	0	577	33	177	27	0	237	1923
% Cars + Trucks	100	99.4	100	0	99.5	97.6	100	100	100	99.7	100	99.0	100	0	99.1	100	100	100	0	100	99.5
% Trucks	0	4	0	0	4	1	0	0	0	1	0	5	0	0	5	0	0	0	0	0	10
% Trucks	0	0.6	0	0	0.5	2.4	0	0	0	0.3	0	1.0	0	0	0.9	0	0	0	0	0	0.5

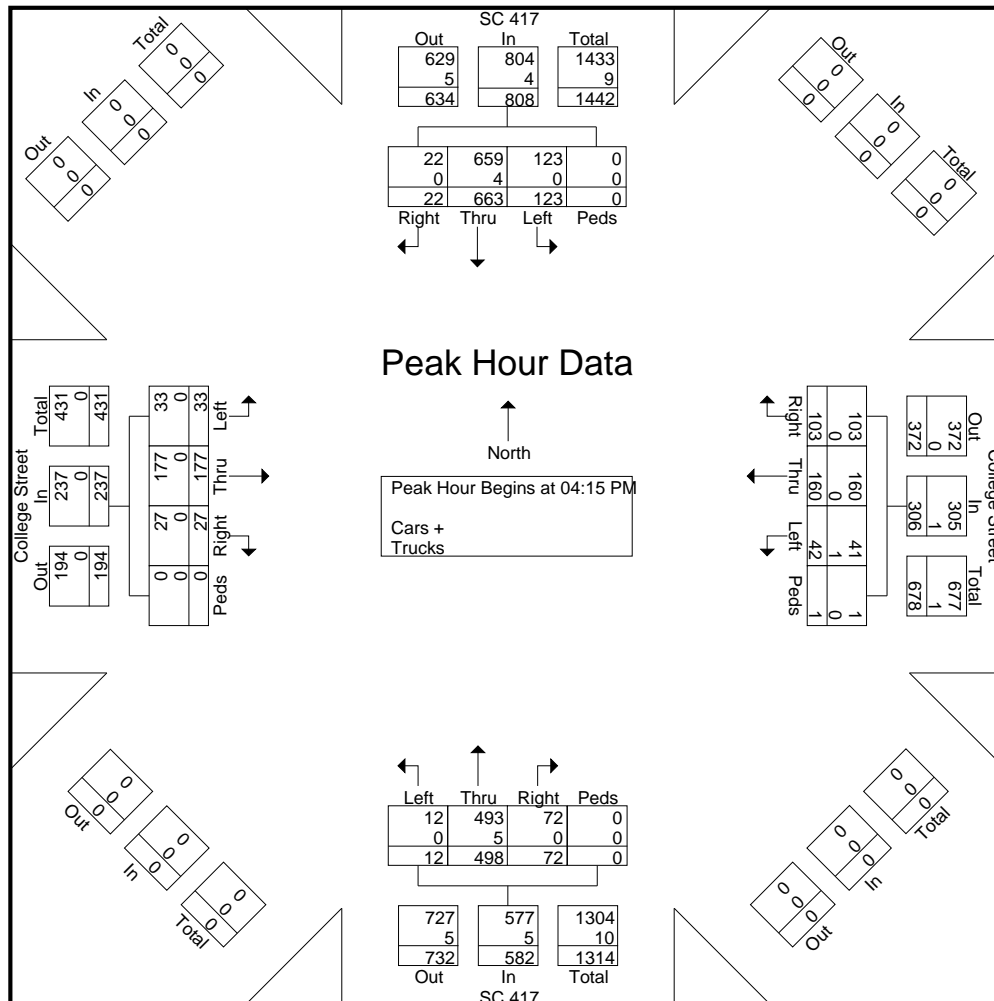



TRAFFIC DATA COLLECTION

File Name : Simpsonville(02 - SC 417 and Curtis Street)
 Site Code :
 Start Date : 9/24/2025
 Page No : 1

Groups Printed- Cars + - Trucks

Start Time	SC 417 Southbound					Curtis Street Westbound					SC 417 Northbound					Curtis Street Eastbound					Int. Total
	Left	Thru	Right	Peds	App. Total	Left	Thru	Right	Peds	App. Total	Left	Thru	Right	Peds	App. Total	Left	Thru	Right	Peds	App. Total	
07:00 AM	23	61	3	0	87	5	83	30	0	118	8	61	20	0	89	4	43	0	0	47	341
07:15 AM	30	73	2	0	105	9	88	27	1	125	10	102	17	0	129	2	38	1	0	41	400
07:30 AM	33	93	2	1	129	14	55	31	0	100	9	99	13	0	121	5	50	5	0	60	410
07:45 AM	25	103	8	0	136	10	61	43	0	114	3	97	6	0	106	12	44	3	0	59	415
Total	111	330	15	1	457	38	287	131	1	457	30	359	56	0	445	23	175	9	0	207	1566
08:00 AM	36	122	6	0	164	12	69	24	0	105	3	100	9	0	112	6	48	4	0	58	439
08:15 AM	24	124	5	0	153	15	50	24	0	89	7	114	15	0	136	2	47	1	0	50	428
08:30 AM	25	85	6	0	116	15	64	20	0	99	13	113	10	1	137	1	38	3	0	42	394
08:45 AM	28	79	6	0	113	15	54	16	0	85	6	100	6	1	113	10	40	6	0	56	367
Total	113	410	23	0	546	57	237	84	0	378	29	427	40	2	498	19	173	14	0	206	1628
Grand Total	224	740	38	1	1003	95	524	215	1	835	59	786	96	2	943	42	348	23	0	413	3194
Apprch %	22.3	73.8	3.8	0.1		11.4	62.8	25.7	0.1		6.3	83.4	10.2	0.2		10.2	84.3	5.6	0		
Total %	7	23.2	1.2	0	31.4	3	16.4	6.7	0	26.1	1.8	24.6	3	0.1	29.5	1.3	10.9	0.7	0	12.9	
Cars +	216	724	36	1	977	83	505	211	1	800	58	769	93	2	922	42	330	23	0	395	3094
% Cars +	96.4	97.8	94.7	100	97.4	87.4	96.4	98.1	100	95.8	98.3	97.8	96.9	100	97.8	100	94.8	100	0	95.6	96.9
Trucks	8	16	2	0	26	12	19	4	0	35	1	17	3	0	21	0	18	0	0	18	100
% Trucks	3.6	2.2	5.3	0	2.6	12.6	3.6	1.9	0	4.2	1.7	2.2	3.1	0	2.2	0	5.2	0	0	4.4	3.1



TRAFFIC DATA COLLECTION

File Name : Simpsonville(02 - SC 417 and Curtis Street)
 Site Code :
 Start Date : 9/24/2025
 Page No : 2

Start Time	SC 417 Southbound					Curtis Street Westbound					SC 417 Northbound					Curtis Street Eastbound					Int. Total
	Left	Thru	Right	Peds	App. Total	Left	Thru	Right	Peds	App. Total	Left	Thru	Right	Peds	App. Total	Left	Thru	Right	Peds	App. Total	
Peak Hour Analysis From 07:00 AM to 08:45 AM - Peak 1 of 1																					
Peak Hour for Entire Intersection Begins at 07:30 AM																					
07:30 AM	33	93	2	1	129	14	55	31	0	100	9	99	13	0	121	5	50	5	0	60	410
07:45 AM	25	103	8	0	136	10	61	43	0	114	3	97	6	0	106	12	44	3	0	59	415
08:00 AM	36	122	6	0	164	12	69	24	0	105	3	100	9	0	112	6	48	4	0	58	439
08:15 AM	24	124	5	0	153	15	50	24	0	89	7	114	15	0	136	2	47	1	0	50	428
Total Volume	118	442	21	1	582	51	235	122	0	408	22	410	43	0	475	25	189	13	0	227	1692
% App. Total	20.3	75.9	3.6	0.2		12.5	57.6	29.9	0		4.6	86.3	9.1	0		11	83.3	5.7	0		
PHF	.819	.891	.656	.250	.887	.850	.851	.709	.000	.895	.611	.899	.717	.000	.873	.521	.945	.650	.000	.946	.964
Cars + Trucks	113	429	21	1	564	45	224	119	0	388	21	402	41	0	464	25	179	13	0	217	1633
% Cars + Trucks	95.8	97.1	100	100	96.9	88.2	95.3	97.5	0	95.1	95.5	98.0	95.3	0	97.7	100	94.7	100	0	95.6	96.5
% Trucks	5	13	0	0	18	6	11	3	0	20	1	8	2	0	11	0	10	0	0	10	59
% Trucks	4.2	2.9	0	0	3.1	11.8	4.7	2.5	0	4.9	4.5	2.0	4.7	0	2.3	0	5.3	0	0	4.4	3.5

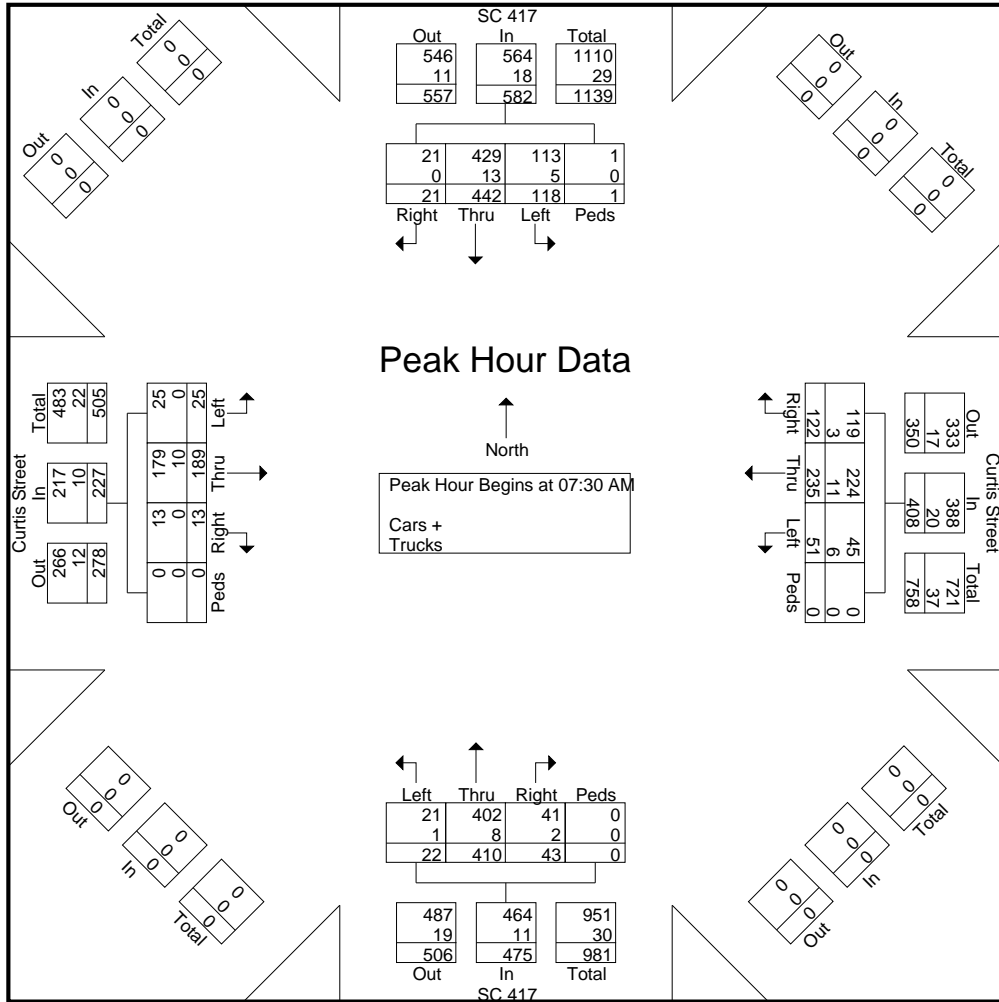



TRAFFIC DATA COLLECTION

File Name : Simpsonville(02 - SC 417 and Curtis Street)
 Site Code :
 Start Date : 9/24/2025
 Page No : 1

Groups Printed- Cars + - Trucks

Start Time	SC 417 Southbound					Curtis Street Westbound					SC 417 Northbound					Curtis Street Eastbound					Int. Total
	Left	Thru	Right	Peds	App. Total	Left	Thru	Right	Peds	App. Total	Left	Thru	Right	Peds	App. Total	Left	Thru	Right	Peds	App. Total	
04:00 PM	44	130	12	0	186	12	33	21	0	66	15	135	29	4	183	8	41	3	0	52	487
04:15 PM	53	120	7	0	180	4	52	16	0	72	10	127	25	1	163	3	55	6	0	64	479
04:30 PM	61	118	7	0	186	10	47	27	0	84	8	111	19	6	144	7	50	1	0	58	472
04:45 PM	52	101	11	0	164	15	37	15	3	70	10	125	26	0	161	4	47	11	0	62	457
Total	210	469	37	0	716	41	169	79	3	292	43	498	99	11	651	22	193	21	0	236	1895
05:00 PM	47	135	12	0	194	5	48	22	0	75	12	120	27	1	160	4	58	4	0	66	495
05:15 PM	47	101	8	0	156	11	40	9	1	61	12	113	39	5	169	3	65	5	0	73	459
05:30 PM	56	124	19	2	201	8	50	6	2	66	12	102	37	0	151	3	64	3	0	70	488
05:45 PM	41	105	12	0	158	6	52	17	5	80	8	121	33	5	167	6	65	9	0	80	485
Total	191	465	51	2	709	30	190	54	8	282	44	456	136	11	647	16	252	21	0	289	1927
Grand Total	401	934	88	2	1425	71	359	133	11	574	87	954	235	22	1298	38	445	42	0	525	3822
Apprch %	28.1	65.5	6.2	0.1		12.4	62.5	23.2	1.9		6.7	73.5	18.1	1.7		7.2	84.8	8	0		
Total %	10.5	24.4	2.3	0.1	37.3	1.9	9.4	3.5	0.3	15	2.3	25	6.1	0.6	34	1	11.6	1.1	0	13.7	
Cars +	398	928	88	2	1416	69	350	131	10	560	86	944	230	20	1280	38	437	42	0	517	3773
% Cars +	99.3	99.4	100	100	99.4	97.2	97.5	98.5	90.9	97.6	98.9	99	97.9	90.9	98.6	100	98.2	100	0	98.5	98.7
Trucks	3	6	0	0	9	2	9	2	1	14	1	10	5	2	18	0	8	0	0	8	49
% Trucks	0.7	0.6	0	0	0.6	2.8	2.5	1.5	9.1	2.4	1.1	1	2.1	9.1	1.4	0	1.8	0	0	1.5	1.3



TRAFFIC DATA COLLECTION

File Name : Simpsonville(02 - SC 417 and Curtis Street)
 Site Code :
 Start Date : 9/24/2025
 Page No : 2

Start Time	SC 417 Southbound					Curtis Street Westbound					SC 417 Northbound					Curtis Street Eastbound					Int. Total
	Left	Thru	Right	Peds	App. Total	Left	Thru	Right	Peds	App. Total	Left	Thru	Right	Peds	App. Total	Left	Thru	Right	Peds	App. Total	
Peak Hour Analysis From 04:00 PM to 05:45 PM - Peak 1 of 1																					
Peak Hour for Entire Intersection Begins at 05:00 PM																					
05:00 PM	47	135	12	0	194	5	48	22	0	75	12	120	27	1	160	4	58	4	0	66	495
05:15 PM	47	101	8	0	156	11	40	9	1	61	12	113	39	5	169	3	65	5	0	73	459
05:30 PM	56	124	19	2	201	8	50	6	2	66	12	102	37	0	151	3	64	3	0	70	488
05:45 PM	41	105	12	0	158	6	52	17	5	80	8	121	33	5	167	6	65	9	0	80	485
Total Volume	191	465	51	2	709	30	190	54	8	282	44	456	136	11	647	16	252	21	0	289	1927
% App. Total	26.9	65.6	7.2	0.3		10.6	67.4	19.1	2.8		6.8	70.5	21	1.7		5.5	87.2	7.3	0		
PHF	.853	.861	.671	.250	.882	.682	.913	.614	.400	.881	.917	.942	.872	.550	.957	.667	.969	.583	.000	.903	.973
Cars + Trucks	189	463	51	2	705	30	185	52	7	274	43	453	135	9	640	16	248	21	0	285	1904
% Cars + Trucks	99.0	99.6	100	100	99.4	100	97.4	96.3	87.5	97.2	97.7	99.3	99.3	81.8	98.9	100	98.4	100	0	98.6	98.8
% Trucks	2	2	0	0	4	0	5	2	1	8	1	3	1	2	7	0	4	0	0	4	23
% Trucks	1.0	0.4	0	0	0.6	0	2.6	3.7	12.5	2.8	2.3	0.7	0.7	18.2	1.1	0	1.6	0	0	1.4	1.2

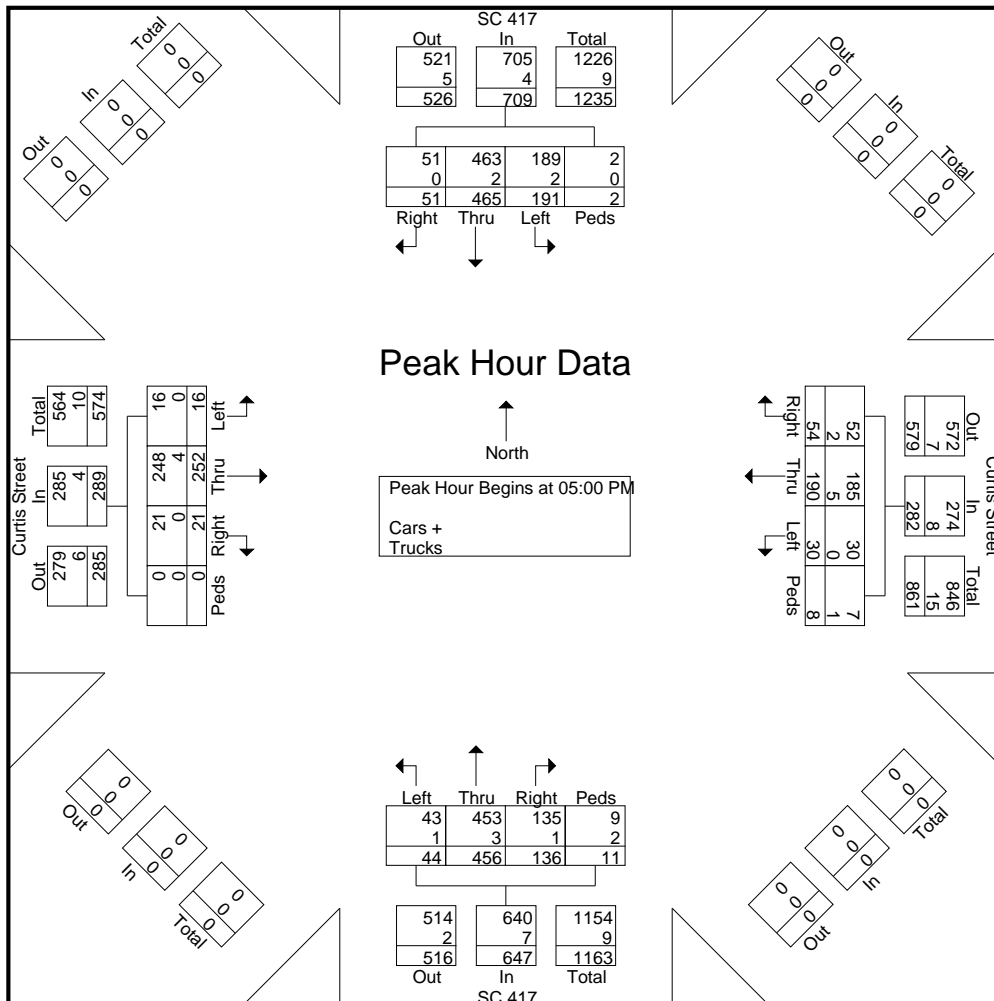



TRAFFIC DATA COLLECTION

File Name : Simpsonville(03 - W. College Street and Main Street (DC)
 Site Code :
 Start Date : 9/24/2025
 Page No : 2

Start Time	Main Street Southbound				College Street Westbound				Main Street Northbound				College Street Eastbound				Int. Total
	Left	Thru	Right	App. Total	Left	Thru	Right	App. Total	Left	Thru	Right	App. Total	Left	Thru	Right	App. Total	
Peak Hour Analysis From 07:00 AM to 08:45 AM - Peak 1 of 1																	
Peak Hour for Entire Intersection Begins at 08:00 AM																	
08:00 AM	1	0	3	4	0	0	1	1	0	0	2	2	0	0	0	0	7
08:15 AM	0	0	6	6	0	0	2	2	0	0	0	0	3	0	0	3	11
08:30 AM	0	0	3	3	4	0	3	7	0	0	1	1	1	0	0	1	12
08:45 AM	0	0	9	9	0	0	3	3	0	0	4	4	1	0	1	2	18
Total Volume	1	0	21	22	4	0	9	13	0	0	7	7	5	0	1	6	48
% App. Total	4.5	0	95.5		30.8	0	69.2		0	0	100		83.3	0	16.7		
PHF	.250	.000	.583	.611	.250	.000	.750	.464	.000	.000	.438	.438	.417	.000	.250	.500	.667

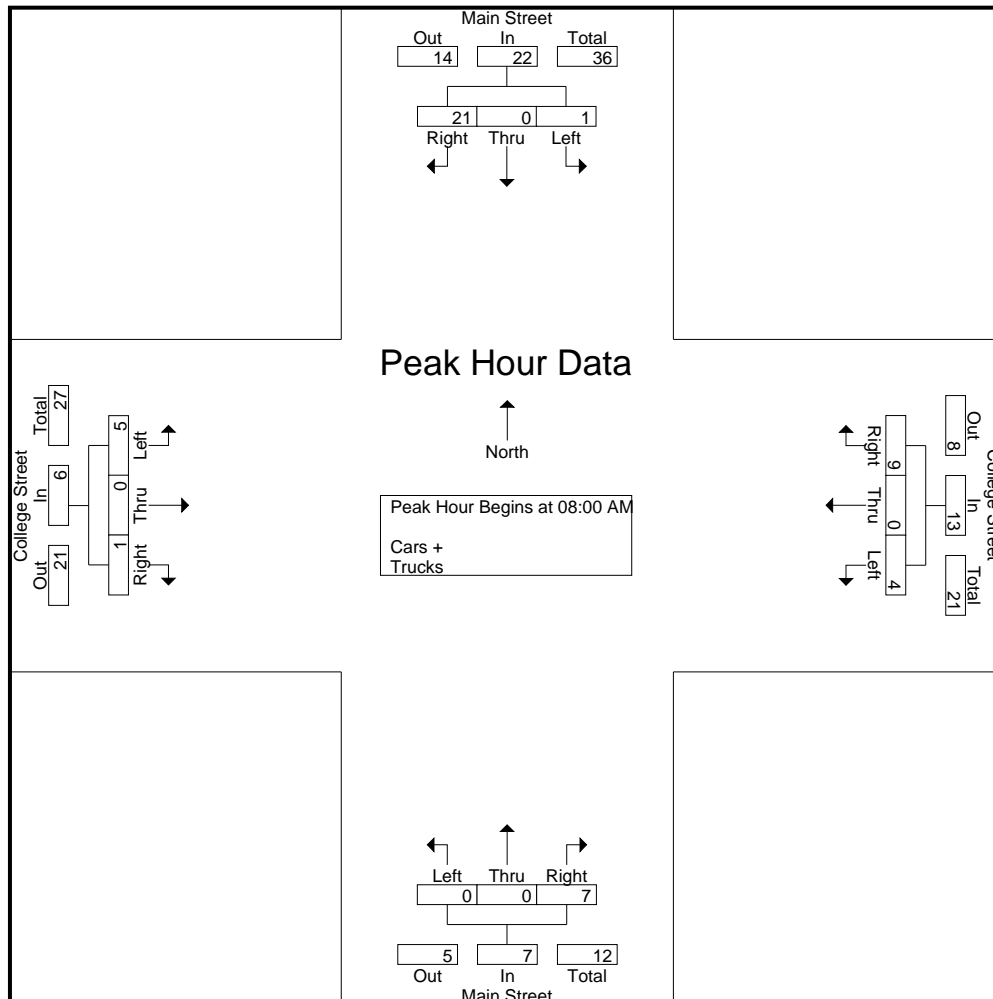



TRAFFIC DATA COLLECTION

File Name : Simpsonville(03 - W. College Street and Main Street (DC)
 Site Code :
 Start Date : 9/24/2025
 Page No : 2

Start Time	Main Street Southbound				College Street Westbound				Main Street Northbound				College Street Eastbound				Int. Total
	Left	Thru	Right	App. Total	Left	Thru	Right	App. Total	Left	Thru	Right	App. Total	Left	Thru	Right	App. Total	
Peak Hour Analysis From 04:00 PM to 05:45 PM - Peak 1 of 1																	
Peak Hour for Entire Intersection Begins at 04:30 PM																	
04:30 PM	5	0	7	12	4	0	2	6	1	0	4	5	0	0	1	1	24
04:45 PM	2	0	6	8	6	0	0	6	2	0	0	2	0	0	0	0	16
05:00 PM	0	0	8	8	2	0	2	4	1	0	0	1	2	0	0	2	15
05:15 PM	7	0	7	14	3	0	0	3	0	0	2	2	1	0	1	2	21
Total Volume	14	0	28	42	15	0	4	19	4	0	6	10	3	0	2	5	76
% App. Total	33.3	0	66.7		78.9	0	21.1		40	0	60		60	0	40		
PHF	.500	.000	.875	.750	.625	.000	.500	.792	.500	.000	.375	.500	.375	.000	.500	.625	.792

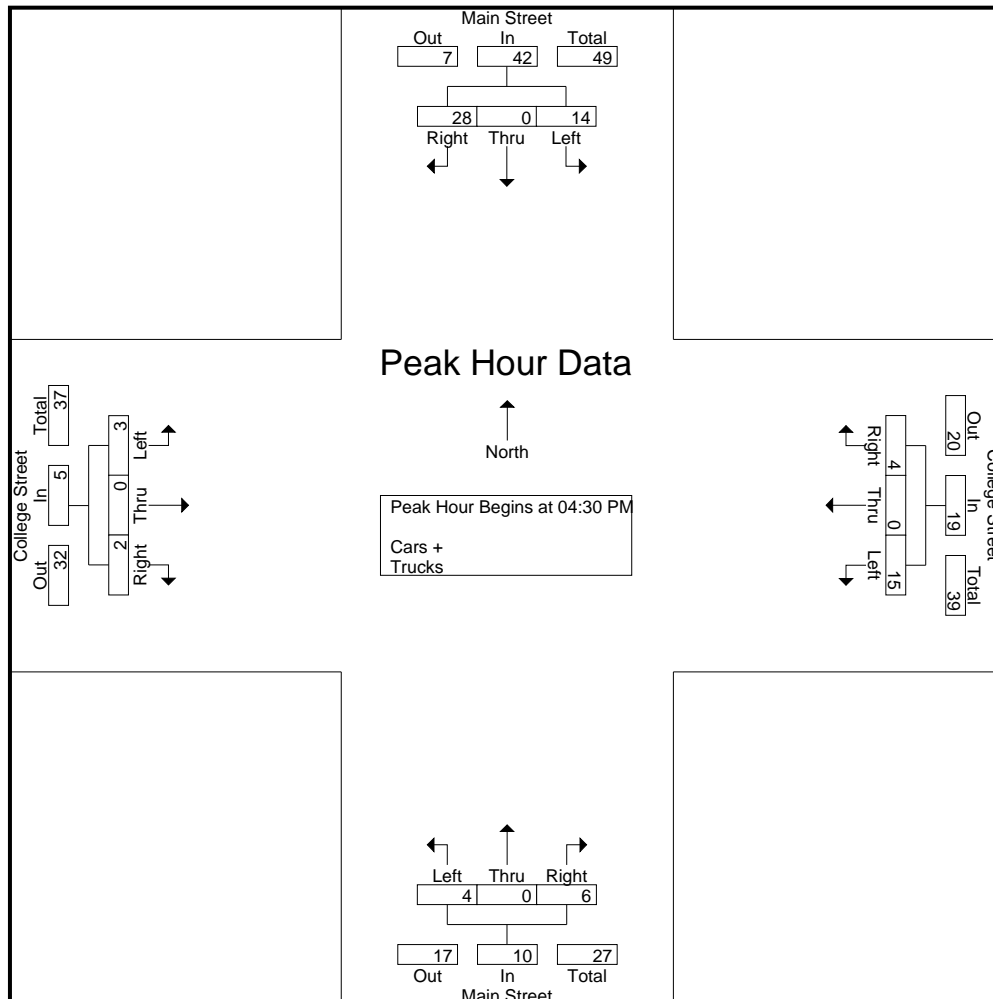



TRAFFIC DATA COLLECTION

File Name : Simpsonville(04 - W. Curtis Street and N. Main Street (DC) (1)
 Site Code :
 Start Date : 9/24/2025
 Page No : 2

Start Time	Main Street Southbound				Curtis Street Westbound				Main Street Northbound				Curtis Street Eastbound				Int. Total
	Left	Thru	Right	App. Total	Left	Thru	Right	App. Total	Left	Thru	Right	App. Total	Left	Thru	Right	App. Total	
Peak Hour Analysis From 07:00 AM to 08:45 AM - Peak 1 of 1																	
Peak Hour for Entire Intersection Begins at 08:00 AM																	
08:00 AM	0	0	5	5	4	0	0	4	2	0	3	5	0	0	4	4	18
08:15 AM	0	0	2	2	2	0	1	3	2	0	0	2	0	0	1	1	8
08:30 AM	0	0	6	6	3	0	2	5	2	0	0	2	1	0	4	5	18
08:45 AM	1	0	3	4	4	0	5	9	8	0	9	17	0	0	2	2	32
Total Volume	1	0	16	17	13	0	8	21	14	0	12	26	1	0	11	12	76
% App. Total	5.9	0	94.1		61.9	0	38.1		53.8	0	46.2		8.3	0	91.7		
PHF	.250	.000	.667	.708	.813	.000	.400	.583	.438	.000	.333	.382	.250	.000	.688	.600	.594

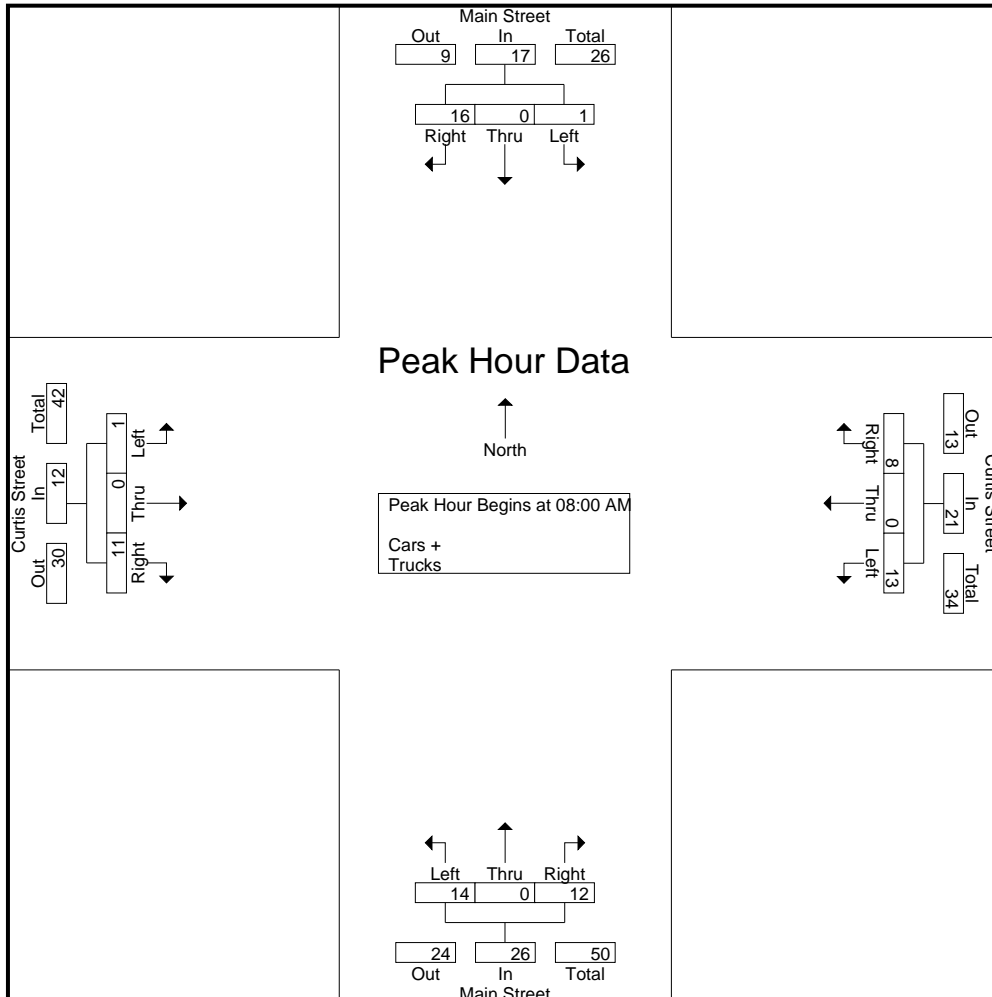



TRAFFIC DATA COLLECTION

File Name : Simpsonville(04 - W. Curtis Street and N. Main Street (DC) (1)
 Site Code :
 Start Date : 9/24/2025
 Page No : 1

Groups Printed- Cars + - Trucks

Start Time	Main Street Southbound				Curtis Street Westbound				Main Street Northbound				Curtis Street Eastbound				Int. Total
	Left	Thru	Right	App. Total	Left	Thru	Right	App. Total	Left	Thru	Right	App. Total	Left	Thru	Right	App. Total	
04:00 PM	1	0	7	8	5	0	2	7	6	0	3	9	1	0	1	2	26
04:15 PM	1	0	9	10	8	0	1	9	6	0	4	10	0	0	0	0	29
04:30 PM	4	0	5	9	9	0	3	12	1	0	3	4	0	0	1	1	26
04:45 PM	2	0	5	7	11	0	4	15	1	0	5	6	2	0	5	7	35
Total	8	0	26	34	33	0	10	43	14	0	15	29	3	0	7	10	116
05:00 PM	2	0	3	5	6	0	2	8	2	0	5	7	0	0	2	2	22
05:15 PM	0	0	10	10	6	0	4	10	1	0	4	5	3	0	0	3	28
05:30 PM	6	0	9	15	9	0	2	11	1	0	3	4	1	0	0	1	31
05:45 PM	3	0	7	10	10	0	2	12	5	0	11	16	0	0	0	0	38
Total	11	0	29	40	31	0	10	41	9	0	23	32	4	0	2	6	119
Grand Total	19	0	55	74	64	0	20	84	23	0	38	61	7	0	9	16	235
Apprch %	25.7	0	74.3		76.2	0	23.8		37.7	0	62.3		43.8	0	56.2		
Total %	8.1	0	23.4	31.5	27.2	0	8.5	35.7	9.8	0	16.2	26	3	0	3.8	6.8	
Cars +	19	0	55	74	64	0	20	84	23	0	38	61	7	0	8	15	234
% Cars +	100	0	100	100	100	0	100	100	100	0	100	100	100	0	88.9	93.8	99.6
Trucks	0	0	0	0	0	0	0	0	0	0	0	0	0	0	1	1	1
% Trucks	0	0	0	0	0	0	0	0	0	0	0	0	0	0	11.1	6.2	0.4



TRAFFIC DATA COLLECTION

File Name : Simpsonville(04 - W. Curtis Street and N. Main Street (DC) (1)
 Site Code :
 Start Date : 9/24/2025
 Page No : 2

Start Time	Main Street Southbound				Curtis Street Westbound				Main Street Northbound				Curtis Street Eastbound				Int. Total
	Left	Thru	Right	App. Total	Left	Thru	Right	App. Total	Left	Thru	Right	App. Total	Left	Thru	Right	App. Total	
Peak Hour Analysis From 04:00 PM to 05:45 PM - Peak 1 of 1																	
Peak Hour for Entire Intersection Begins at 05:00 PM																	
05:00 PM	2	0	3	5	6	0	2	8	2	0	5	7	0	0	2	2	22
05:15 PM	0	0	10	10	6	0	4	10	1	0	4	5	3	0	0	3	28
05:30 PM	6	0	9	15	9	0	2	11	1	0	3	4	1	0	0	1	31
05:45 PM	3	0	7	10	10	0	2	12	5	0	11	16	0	0	0	0	38
Total Volume	11	0	29	40	31	0	10	41	9	0	23	32	4	0	2	6	119
% App. Total	27.5	0	72.5		75.6	0	24.4		28.1	0	71.9		66.7	0	33.3		
PHF	.458	.000	.725	.667	.775	.000	.625	.854	.450	.000	.523	.500	.333	.000	.250	.500	.783

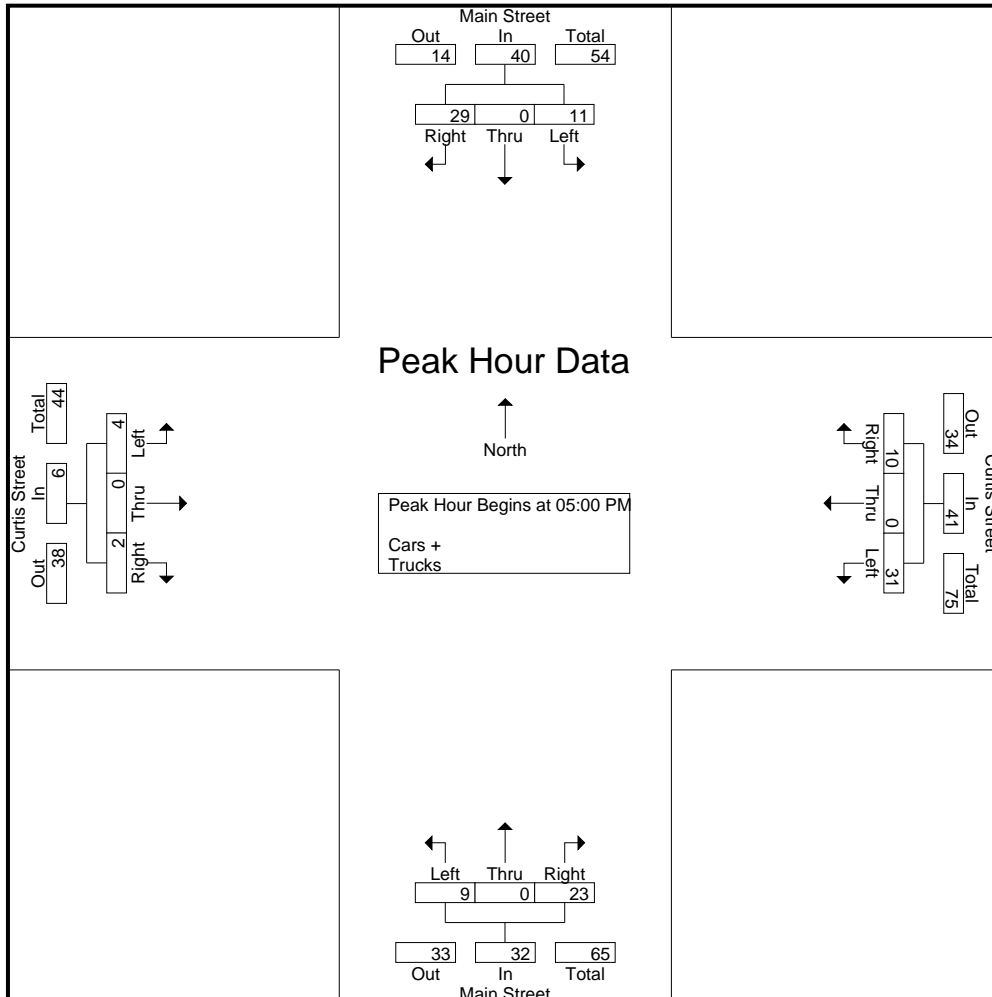



TRAFFIC DATA COLLECTION

File Name : Simpsonville(05 - College St and Hedge Street)
 Site Code :
 Start Date : 9/24/2025
 Page No : 1

Groups Printed- Cars + - Trucks

Start Time	Commercial Access Southbound					College Street Westbound					Hedge Street Northbound					College Street Eastbound					Int. Total
	Left	Thru	Right	Peds	App. Total	Left	Thru	Right	Peds	App. Total	Left	Thru	Right	Peds	App. Total	Left	Thru	Right	Peds	App. Total	
07:00 AM	0	0	0	0	0	6	117	0	0	123	4	0	5	1	10	0	22	6	0	28	161
07:15 AM	0	0	0	0	0	9	130	0	0	139	2	0	8	0	10	1	34	10	0	45	194
07:30 AM	0	0	0	0	0	9	129	0	0	138	0	0	10	1	11	0	31	16	0	47	196
07:45 AM	0	0	0	0	0	19	116	0	0	135	4	0	18	0	22	0	35	10	0	45	202
Total	0	0	0	0	0	43	492	0	0	535	10	0	41	2	53	1	122	42	0	165	753
08:00 AM	0	0	0	0	0	27	107	0	0	134	6	0	16	0	22	0	48	8	0	56	212
08:15 AM	0	0	0	0	0	62	90	0	0	152	2	0	10	0	12	1	39	13	0	53	217
08:30 AM	0	0	0	0	0	18	82	0	0	100	6	0	19	0	25	0	35	10	0	45	170
08:45 AM	0	0	0	0	0	10	83	0	0	93	7	1	11	0	19	1	29	19	0	49	161
Total	0	0	0	0	0	117	362	0	0	479	21	1	56	0	78	2	151	50	0	203	760
Grand Total	0	0	0	0	0	160	854	0	0	1014	31	1	97	2	131	3	273	92	0	368	1513
Apprch %	0	0	0	0		15.8	84.2	0	0		23.7	0.8	74	1.5		0.8	74.2	25	0		
Total %	0	0	0	0	0	10.6	56.4	0	0	67	2	0.1	6.4	0.1	8.7	0.2	18	6.1	0	24.3	
Cars +	0	0	0	0	0	160	846	0	0	1006	31	1	97	2	131	3	266	92	0	361	1498
% Cars +	0	0	0	0	0	100	99.1	0	0	99.2	100	100	100	100	100	100	97.4	100	0	98.1	99
Trucks	0	0	0	0	0	0	8	0	0	8	0	0	0	0	0	0	7	0	0	7	15
% Trucks	0	0	0	0	0	0	0.9	0	0	0.8	0	0	0	0	0	0	2.6	0	0	1.9	1



TRAFFIC DATA COLLECTION

File Name : Simpsonville(05 - College St and Hedge Street)
 Site Code :
 Start Date : 9/24/2025
 Page No : 2

Start Time	Commercial Access Southbound					College Street Westbound					Hedge Street Northbound					College Street Eastbound					Int. Total
	Left	Thru	Right	Peds	App. Total	Left	Thru	Right	Peds	App. Total	Left	Thru	Right	Peds	App. Total	Left	Thru	Right	Peds	App. Total	
Peak Hour Analysis From 07:00 AM to 08:45 AM - Peak 1 of 1																					
Peak Hour for Entire Intersection Begins at 07:30 AM																					
07:30 AM	0	0	0	0	0	9	129	0	0	138	0	0	10	1	11	0	31	16	0	47	196
07:45 AM	0	0	0	0	0	19	116	0	0	135	4	0	18	0	22	0	35	10	0	45	202
08:00 AM	0	0	0	0	0	27	107	0	0	134	6	0	16	0	22	0	48	8	0	56	212
08:15 AM	0	0	0	0	0	62	90	0	0	152	2	0	10	0	12	1	39	13	0	53	217
Total Volume	0	0	0	0	0	117	442	0	0	559	12	0	54	1	67	1	153	47	0	201	827
% App. Total	0	0	0	0	0	20.9	79.1	0	0	0	17.9	0	80.6	1.5	0	0.5	76.1	23.4	0	0	0
PHF	.000	.000	.000	.000	.000	.472	.857	.000	.000	.919	.500	.000	.750	.250	.761	.250	.797	.734	.000	.897	.953
Cars + Trucks	0	0	0	0	0	117	437	0	0	554	12	0	54	1	67	1	150	47	0	198	819
% Cars + Trucks	0	0	0	0	0	100	98.9	0	0	99.1	100	0	100	100	100	100	98.0	100	0	98.5	99.0
% Trucks	0	0	0	0	0	0	5	0	0	5	0	0	0	0	0	0	3	0	0	3	8
% Trucks	0	0	0	0	0	0	1.1	0	0	0.9	0	0	0	0	0	0	2.0	0	0	1.5	1.0

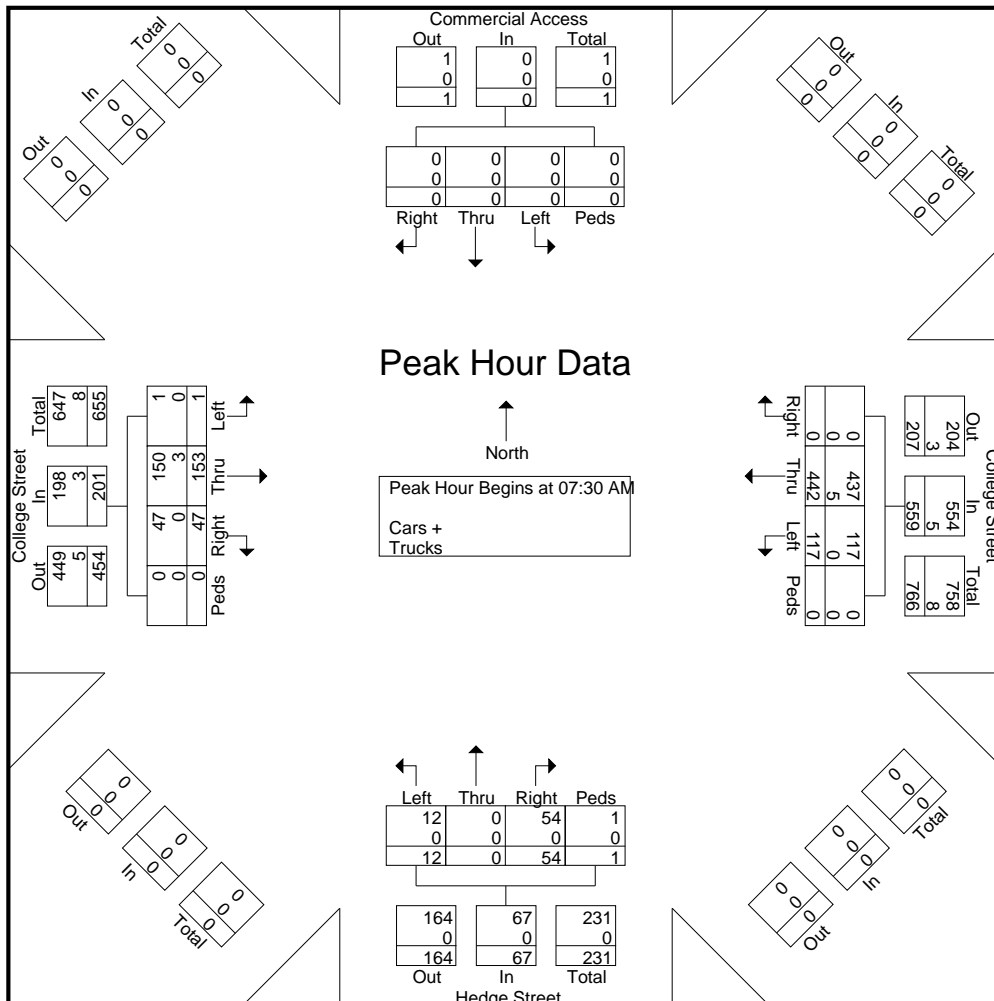



TRAFFIC DATA COLLECTION

File Name : Simpsonville(05 - College St and Hedge Street)
 Site Code :
 Start Date : 9/24/2025
 Page No : 1

Groups Printed- Cars + - Trucks

Start Time	Commercial Access Southbound					College Street Westbound					Hedge Street Northbound					College Street Eastbound					Int. Total
	Left	Thru	Right	Peds	App. Total	Left	Thru	Right	Peds	App. Total	Left	Thru	Right	Peds	App. Total	Left	Thru	Right	Peds	App. Total	
04:00 PM	0	0	1	0	1	10	54	0	0	64	12	0	24	0	36	0	69	31	0	100	201
04:15 PM	0	0	1	0	1	16	80	0	0	96	5	0	14	0	19	1	60	34	0	95	211
04:30 PM	0	0	0	0	0	9	67	0	0	76	1	0	9	0	10	0	69	18	0	87	173
04:45 PM	0	0	0	0	0	17	73	0	0	90	3	0	15	0	18	1	67	23	0	91	199
Total	0	0	2	0	2	52	274	0	0	326	21	0	62	0	83	2	265	106	0	373	784
05:00 PM	0	0	3	0	3	8	77	0	0	85	0	0	19	0	19	0	70	28	0	98	205
05:15 PM	0	0	0	2	2	14	59	0	0	73	7	0	13	0	20	1	74	31	0	106	201
05:30 PM	0	0	1	0	1	11	74	0	0	85	1	0	16	0	17	1	78	35	0	114	217
05:45 PM	0	0	2	0	2	11	58	3	0	72	1	0	8	0	9	0	109	39	0	148	231
Total	0	0	6	2	8	44	268	3	0	315	9	0	56	0	65	2	331	133	0	466	854
Grand Total	0	0	8	2	10	96	542	3	0	641	30	0	118	0	148	4	596	239	0	839	1638
Apprch %	0	0	80	20		15	84.6	0.5	0		20.3	0	79.7	0		0.5	71	28.5	0		
Total %	0	0	0.5	0.1	0.6	5.9	33.1	0.2	0	39.1	1.8	0	7.2	0	9	0.2	36.4	14.6	0	51.2	
Cars +	0	0	8	2	10	96	538	3	0	637	30	0	118	0	148	4	595	238	0	837	1632
% Cars +	0	0	100	100	100	100	99.3	100	0	99.4	100	0	100	0	100	100	99.8	99.6	0	99.8	99.6
Trucks	0	0	0	0	0	0	4	0	0	4	0	0	0	0	0	0	1	1	0	2	6
% Trucks	0	0	0	0	0	0	0.7	0	0	0.6	0	0	0	0	0	0	0.2	0.4	0	0.2	0.4



TRAFFIC DATA COLLECTION

File Name : Simpsonville(05 - College St and Hedge Street)
 Site Code :
 Start Date : 9/24/2025
 Page No : 2

Start Time	Commercial Access Southbound					College Street Westbound					Hedge Street Northbound					College Street Eastbound					Int. Total
	Left	Thru	Right	Peds	App. Total	Left	Thru	Right	Peds	App. Total	Left	Thru	Right	Peds	App. Total	Left	Thru	Right	Peds	App. Total	
Peak Hour Analysis From 04:00 PM to 05:45 PM - Peak 1 of 1																					
Peak Hour for Entire Intersection Begins at 05:00 PM																					
05:00 PM	0	0	3	0	3	8	77	0	0	85	0	0	19	0	19	0	70	28	0	98	205
05:15 PM	0	0	0	2	2	14	59	0	0	73	7	0	13	0	20	1	74	31	0	106	201
05:30 PM	0	0	1	0	1	11	74	0	0	85	1	0	16	0	17	1	78	35	0	114	217
05:45 PM	0	0	2	0	2	11	58	3	0	72	1	0	8	0	9	0	109	39	0	148	231
Total Volume	0	0	6	2	8	44	268	3	0	315	9	0	56	0	65	2	331	133	0	466	854
% App. Total	0	0	75	25		14	85.1	1	0		13.8	0	86.2	0		0.4	71	28.5	0		
PHF	.000	.000	.500	.250	.667	.786	.870	.250	.000	.926	.321	.000	.737	.000	.813	.500	.759	.853	.000	.787	.924
Cars + Trucks	0	0	6	2	8	44	266	3	0	313	9	0	56	0	65	2	331	133	0	466	852
% Cars + Trucks	0	0	100	100	100	100	99.3	100	0	99.4	100	0	100	0	100	100	100	100	0	100	99.8
% Trucks	0	0	0	0	0	0	2	0	0	2	0	0	0	0	0	0	0	0	0	0	2
% Trucks	0	0	0	0	0	0	0.7	0	0	0.6	0	0	0	0	0	0	0	0	0	0	0.2

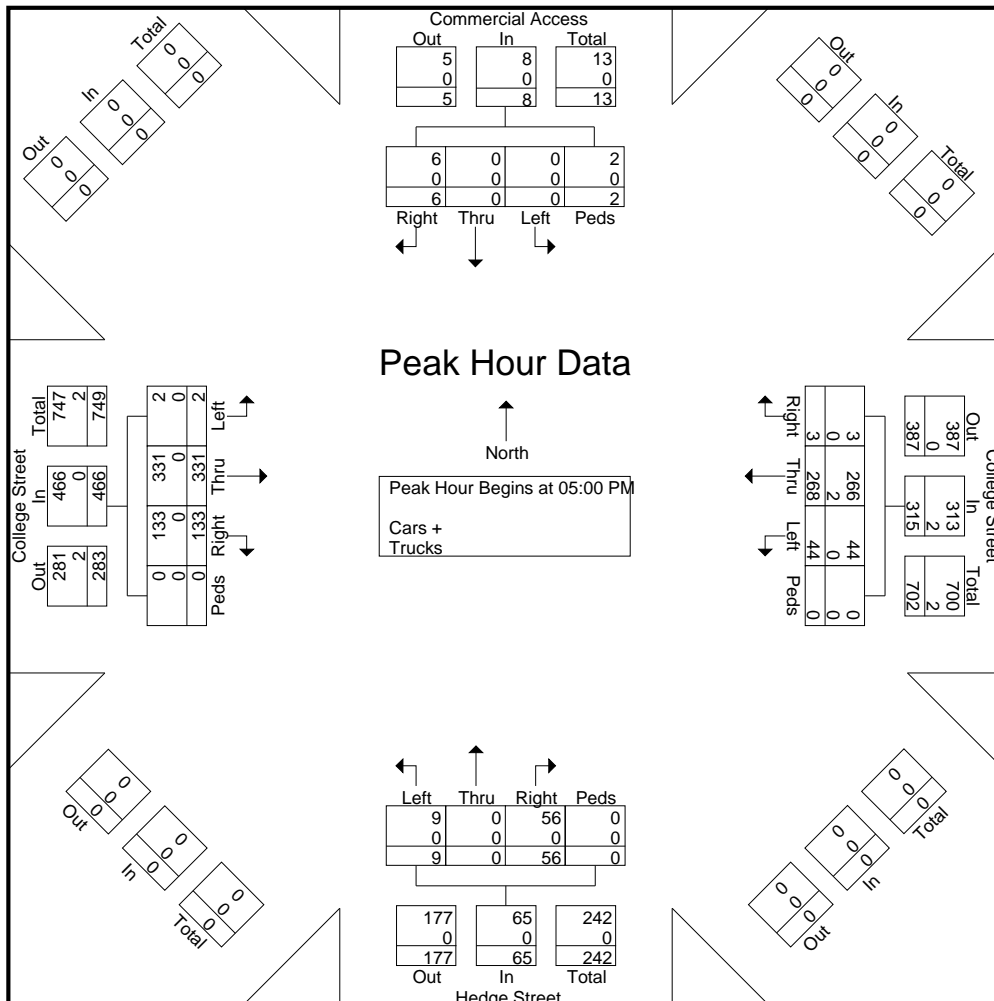



TRAFFIC DATA COLLECTION

File Name : Simpsonville(06 - Curtis Street and Hedge Street)
 Site Code :
 Start Date : 9/24/2025
 Page No : 1

Groups Printed- Cars + - Trucks

Start Time	Hedge Street Southbound					Curtis Street Westbound					Hedge Street Northbound					Curtis Street Eastbound					Int. Total
	Left	Thru	Right	Peds	App. Total	Left	Thru	Right	Peds	App. Total	Left	Thru	Right	Peds	App. Total	Left	Thru	Right	Peds	App. Total	
07:00 AM	5	5	1	0	11	2	121	3	0	126	0	5	14	0	19	1	83	0	0	84	240
07:15 AM	9	6	1	0	16	4	119	1	0	124	0	9	18	0	27	1	81	1	0	83	250
07:30 AM	10	11	0	1	22	12	103	4	0	119	0	12	25	0	37	0	96	1	0	97	275
07:45 AM	14	25	2	0	41	14	109	5	0	128	2	17	30	0	49	2	70	3	0	75	293
Total	38	47	4	1	90	32	452	13	0	497	2	43	87	0	132	4	330	5	0	339	1058
08:00 AM	6	29	1	0	36	16	100	2	1	119	1	21	32	0	54	1	90	1	0	92	301
08:15 AM	7	66	1	0	74	24	91	3	1	119	0	10	25	0	35	0	87	0	0	87	315
08:30 AM	8	25	0	0	33	18	97	2	0	117	4	25	42	0	71	1	72	0	1	74	295
08:45 AM	7	13	4	0	24	16	79	2	0	97	5	19	29	0	53	4	67	1	0	72	246
Total	28	133	6	0	167	74	367	9	2	452	10	75	128	0	213	6	316	2	1	325	1157
Grand Total	66	180	10	1	257	106	819	22	2	949	12	118	215	0	345	10	646	7	1	664	2215
Apprch %	25.7	70	3.9	0.4		11.2	86.3	2.3	0.2		3.5	34.2	62.3	0		1.5	97.3	1.1	0.2		
Total %	3	8.1	0.5	0	11.6	4.8	37	1	0.1	42.8	0.5	5.3	9.7	0	15.6	0.5	29.2	0.3	0	30	
Cars +	66	180	10	1	257	106	784	22	1	913	11	118	211	0	340	10	617	7	1	635	2145
% Cars +	100	100	100	100	100	100	95.7	100	50	96.2	91.7	100	98.1	0	98.6	100	95.5	100	100	95.6	96.8
Trucks	0	0	0	0	0	0	35	0	1	36	1	0	4	0	5	0	29	0	0	29	70
% Trucks	0	0	0	0	0	0	4.3	0	50	3.8	8.3	0	1.9	0	1.4	0	4.5	0	0	4.4	3.2



TRAFFIC DATA COLLECTION

File Name : Simpsonville(06 - Curtis Street and Hedge Street)
 Site Code :
 Start Date : 9/24/2025
 Page No : 2

Start Time	Hedge Street Southbound					Curtis Street Westbound					Hedge Street Northbound					Curtis Street Eastbound					Int. Total
	Left	Thru	Right	Peds	App. Total	Left	Thru	Right	Peds	App. Total	Left	Thru	Right	Peds	App. Total	Left	Thru	Right	Peds	App. Total	
Peak Hour Analysis From 07:00 AM to 08:45 AM - Peak 1 of 1																					
Peak Hour for Entire Intersection Begins at 07:45 AM																					
07:45 AM	14	25	2	0	41	14	109	5	0	128	2	17	30	0	49	2	70	3	0	75	293
08:00 AM	6	29	1	0	36	16	100	2	1	119	1	21	32	0	54	1	90	1	0	92	301
08:15 AM	7	66	1	0	74	24	91	3	1	119	0	10	25	0	35	0	87	0	0	87	315
08:30 AM	8	25	0	0	33	18	97	2	0	117	4	25	42	0	71	1	72	0	1	74	295
Total Volume	35	145	4	0	184	72	397	12	2	483	7	73	129	0	209	4	319	4	1	328	1204
% App. Total	19	78.8	2.2	0	100	14.9	82.2	2.5	0.4	95.4	3.3	34.9	61.7	0	98.6	1.2	97.3	1.2	0.3	94.2	96.3
PHF	.625	.549	.500	.000	.622	.750	.911	.600	.500	.943	.438	.730	.768	.000	.736	.500	.886	.333	.250	.891	.956
Cars + Trucks	35	145	4	0	184	72	376	12	1	461	7	73	126	0	206	4	300	4	1	309	1160
% Cars + Trucks	100	100	100	0	100	100	94.7	100	50.0	95.4	100	100	97.7	0	98.6	100	94.0	100	100	94.2	96.3
% Trucks	0	0	0	0	0	0	21	0	1	22	0	0	3	0	3	0	19	0	0	19	44
% Trucks	0	0	0	0	0	0	5.3	0	50.0	4.6	0	0	2.3	0	1.4	0	6.0	0	0	5.8	3.7

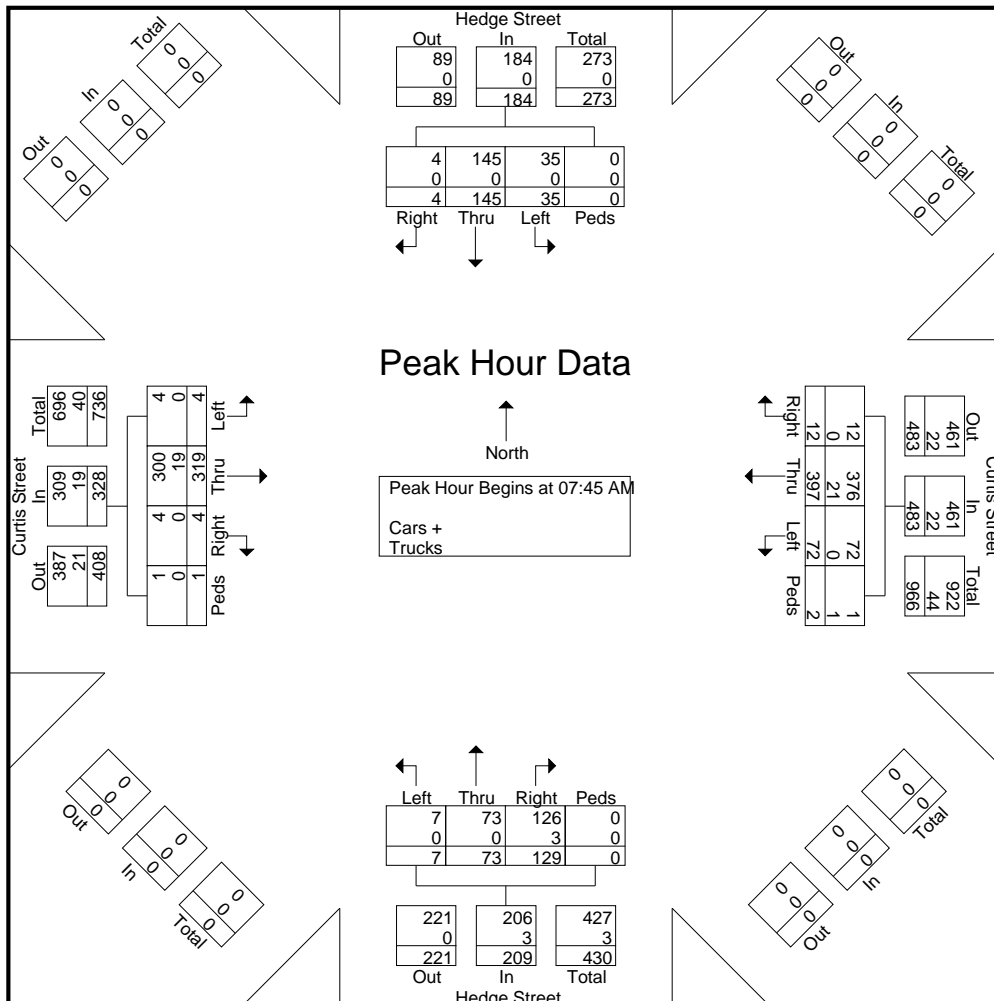



TRAFFIC DATA COLLECTION

File Name : Simpsonville(06 - Curtis Street and Hedge Street)
 Site Code :
 Start Date : 9/24/2025
 Page No : 1

Groups Printed- Cars + - Trucks

Start Time	Hedge Street Southbound					Curtis Street Westbound					Hedge Street Northbound					Curtis Street Eastbound					Int. Total
	Left	Thru	Right	Peds	App. Total	Left	Thru	Right	Peds	App. Total	Left	Thru	Right	Peds	App. Total	Left	Thru	Right	Peds	App. Total	
04:00 PM	23	12	0	0	35	10	65	3	0	78	0	23	44	0	67	2	113	2	0	117	297
04:15 PM	41	16	0	0	57	15	70	2	0	87	2	15	34	0	51	4	122	5	0	131	326
04:30 PM	16	12	2	0	30	14	70	1	0	85	3	10	50	1	64	1	134	2	0	137	316
04:45 PM	22	16	3	0	41	11	55	1	0	67	2	16	45	0	63	4	104	4	0	112	283
Total	102	56	5	0	163	50	260	7	0	317	7	64	173	1	245	11	473	13	0	497	1222
05:00 PM	26	12	1	0	39	21	75	1	0	97	1	13	47	0	61	2	127	4	4	137	334
05:15 PM	32	21	1	2	56	14	66	5	0	85	2	22	60	1	85	4	145	1	2	152	378
05:30 PM	29	13	1	0	43	21	64	1	0	86	0	23	52	0	75	3	143	6	0	152	356
05:45 PM	20	21	3	0	44	19	70	4	0	93	2	20	50	0	72	7	127	0	2	136	345
Total	107	67	6	2	182	75	275	11	0	361	5	78	209	1	293	16	542	11	8	577	1413
Grand Total	209	123	11	2	345	125	535	18	0	678	12	142	382	2	538	27	1015	24	8	1074	2635
Apprch %	60.6	35.7	3.2	0.6		18.4	78.9	2.7	0		2.2	26.4	71	0.4		2.5	94.5	2.2	0.7		
Total %	7.9	4.7	0.4	0.1	13.1	4.7	20.3	0.7	0	25.7	0.5	5.4	14.5	0.1	20.4	1	38.5	0.9	0.3	40.8	
Cars +	209	123	11	2	345	125	521	18	0	664	12	142	379	0	533	27	999	24	8	1058	2600
% Cars +	100	100	100	100	100	100	97.4	100	0	97.9	100	100	99.2	0	99.1	100	98.4	100	100	98.5	98.7
Trucks	0	0	0	0	0	0	14	0	0	14	0	0	3	2	5	0	16	0	0	16	35
% Trucks	0	0	0	0	0	0	2.6	0	0	2.1	0	0	0.8	100	0.9	0	1.6	0	0	1.5	1.3



TRAFFIC DATA COLLECTION

File Name : Simpsonville(06 - Curtis Street and Hedge Street)
 Site Code :
 Start Date : 9/24/2025
 Page No : 2

Start Time	Hedge Street Southbound					Curtis Street Westbound					Hedge Street Northbound					Curtis Street Eastbound					Int. Total
	Left	Thru	Right	Peds	App. Total	Left	Thru	Right	Peds	App. Total	Left	Thru	Right	Peds	App. Total	Left	Thru	Right	Peds	App. Total	
Peak Hour Analysis From 04:00 PM to 05:45 PM - Peak 1 of 1																					
Peak Hour for Entire Intersection Begins at 05:00 PM																					
05:00 PM	26	12	1	0	39	21	75	1	0	97	1	13	47	0	61	2	127	4	4	137	334
05:15 PM	32	21	1	2	56	14	66	5	0	85	2	22	60	1	85	4	145	1	2	152	378
05:30 PM	29	13	1	0	43	21	64	1	0	86	0	23	52	0	75	3	143	6	0	152	356
05:45 PM	20	21	3	0	44	19	70	4	0	93	2	20	50	0	72	7	127	0	2	136	345
Total Volume	107	67	6	2	182	75	275	11	0	361	5	78	209	1	293	16	542	11	8	577	1413
% App. Total	58.8	36.8	3.3	1.1		20.8	76.2	3	0		1.7	26.6	71.3	0.3		2.8	93.9	1.9	1.4		
PHF	.836	.798	.500	.250	.813	.893	.917	.550	.000	.930	.625	.848	.871	.250	.862	.571	.934	.458	.500	.949	.935
Cars + Trucks	107	67	6	2	182	75	266	11	0	352	5	78	208	0	291	16	535	11	8	570	1395
% Cars + Trucks	100	100	100	100	100	100	96.7	100	0	97.5	100	100	99.5	0	99.3	100	98.7	100	100	98.8	98.7
% Trucks	0	0	0	0	0	0	9	0	0	9	0	0	1	1	2	0	7	0	0	7	18
	0	0	0	0	0	0	3.3	0	0	2.5	0	0	0.5	100	0.7	0	1.3	0	0	1.2	1.3

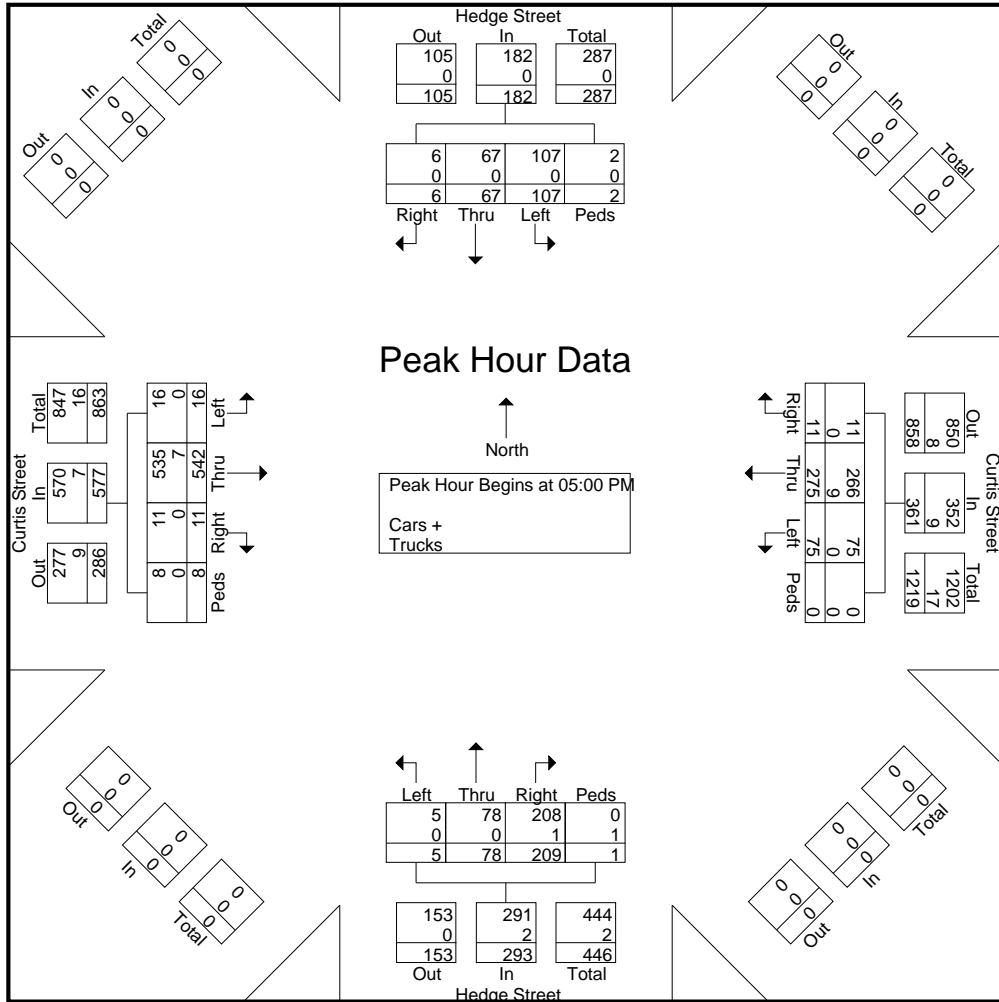

APPENDIX B

TURN LANE ANALYSIS

Hedge Street & Access A

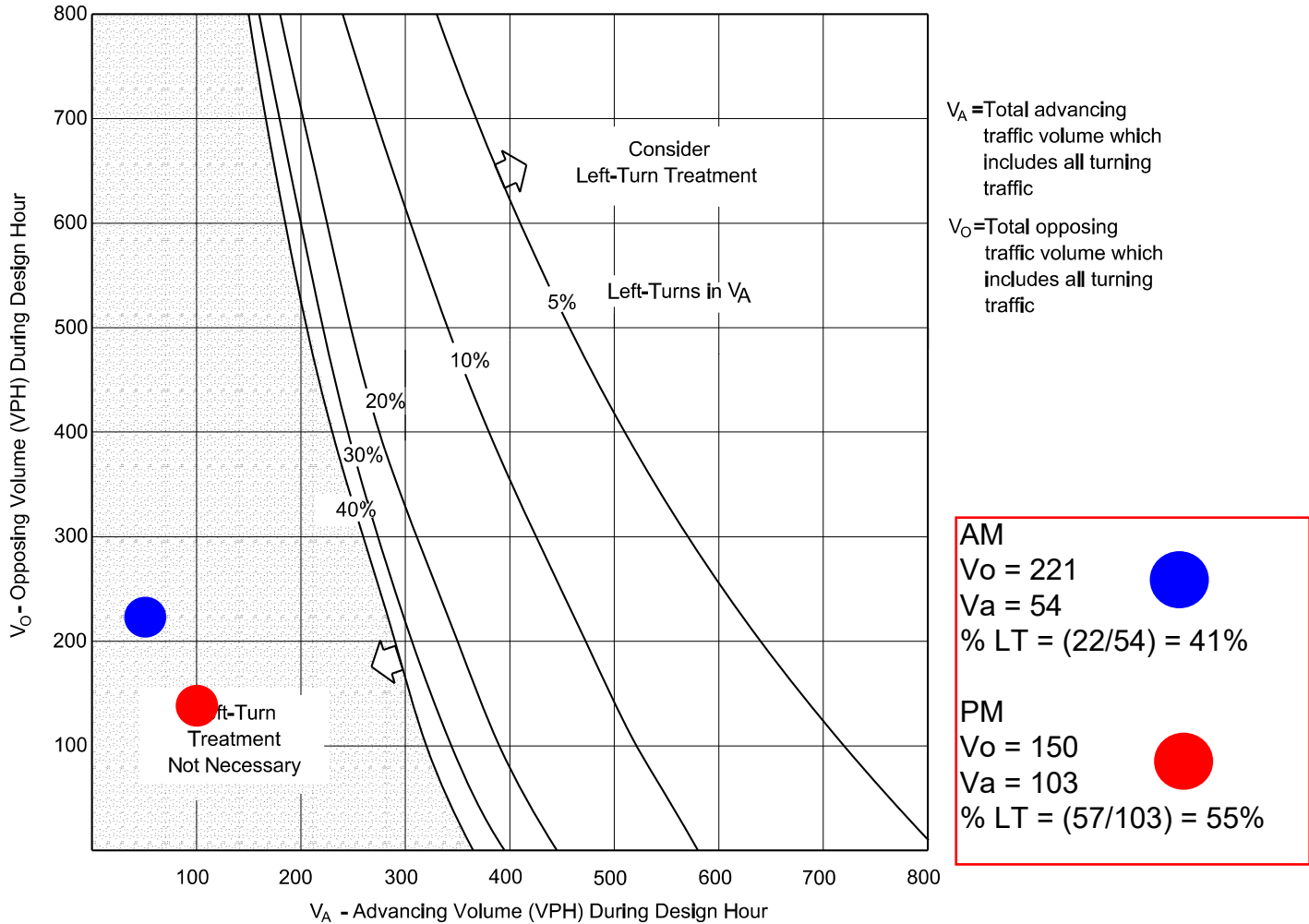

Instructions:

1. *The family of curves represents the percent of left turns in the advancing volume (V_A). The designer should locate the curve for the actual percentage of left turns. When this is not an even increment of 5, the designer should estimate where the curve lies.*
2. *Read V_A and V_O into the chart and locate the intersection of the two volumes.*
3. *Note the location of the point in #2 relative to the line in #1. If the point is to the right of the line, then a left-turn lane is warranted. If the point is to the left of the line, then a left-turn lane is not warranted based on traffic volumes.*

VOLUME GUIDELINES FOR LEFT-TURN LANES AT UNSIGNALIZED INTERSECTIONS ON TWO-LANE HIGHWAYS (40 mph)

Figure 9.5-G

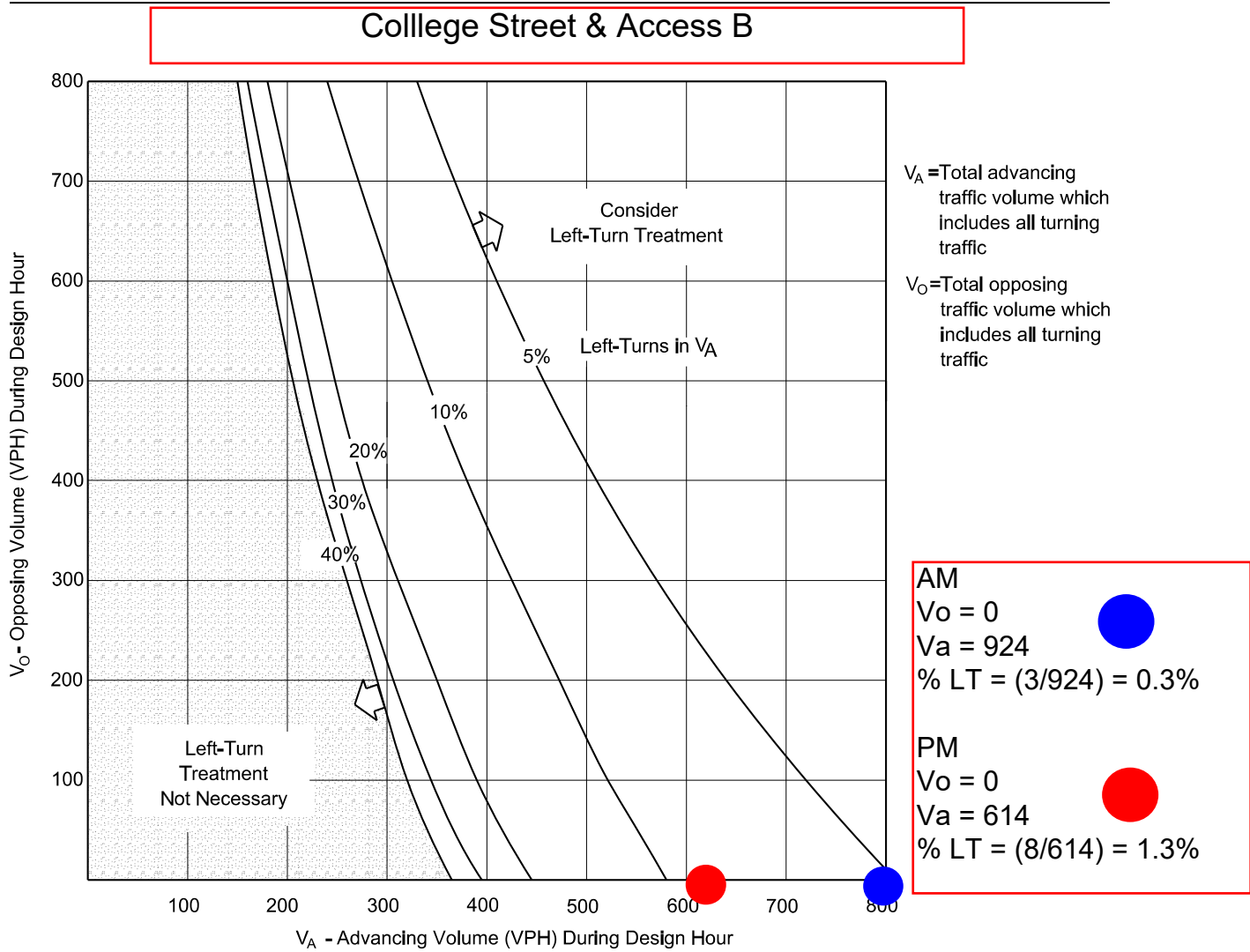

Instructions:

1. The family of curves represents the percent of left turns in the advancing volume (V_A). The designer should locate the curve for the actual percentage of left turns. When this is not an even increment of 5, the designer should estimate where the curve lies.
2. Read V_A and V_O into the chart and locate the intersection of the two volumes.
3. Note the location of the point in #2 relative to the line in #1. If the point is to the right of the line, then a left-turn lane is warranted. If the point is to the left of the line, then a left-turn lane is not warranted based on traffic volumes.

VOLUME GUIDELINES FOR LEFT-TURN LANES AT UNSIGNALIZED INTERSECTIONS ON TWO-LANE HIGHWAYS (40 mph)

Figure 9.5-G

Hedge Street & Access A

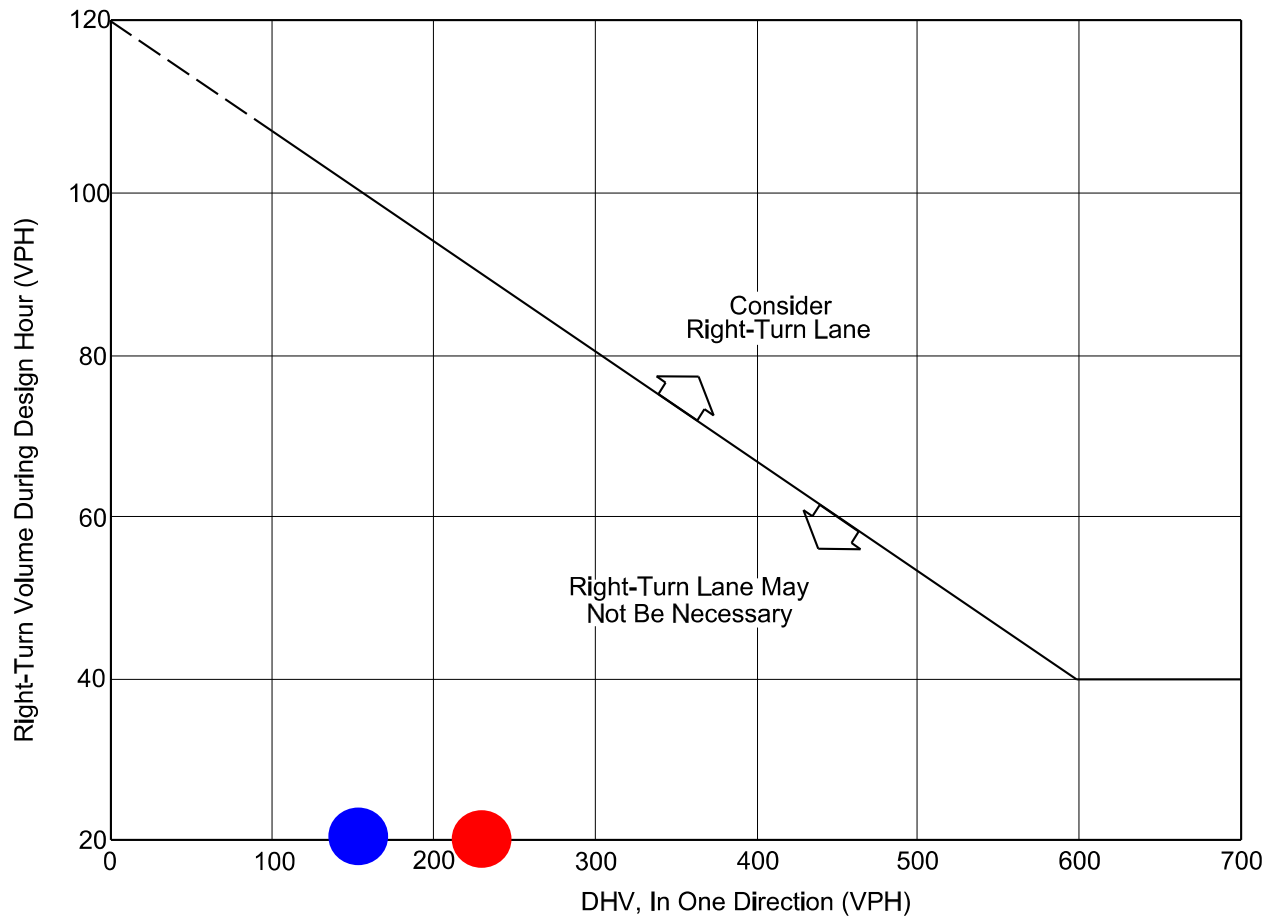

Note: For highways with a design speed below 50 miles per hour with a DHV < 300 and where right turns > 40, an adjustment should be used. To read the vertical axis of the chart, subtract 20 from the actual number of right turns.

Example

Given: Design Speed = 35 miles per hour
 DHV = 250 vehicles per hour
 Right Turns = 100 vehicles per hour

AM ●
 DHV = 221
 RT = 4

PM ●
 DHV = 150
 RT = 12

Problem: Determine if a right-turn lane is necessary.

Solution: To read the vertical axis, use $100 - 20 = 80$ vehicles per hour. The figure indicates that a right-turn lane is not necessary, unless other factors (e.g., high crash rate) indicate a lane is needed.

**GUIDELINES FOR RIGHT-TURN LANES AT UNSIGNALIZED INTERSECTIONS
 ON TWO-LANE HIGHWAYS
 Figure 9.5-A**

APPENDIX C

SYNCHRO ANALYSIS REPORTS

Lanes, Volumes, Timings
 1: NE Main Street (SC 417) & College Street

Existing (2025) AM
 Burdette North TIS



Lane Group	EBL	EBT	EBR	WBL	WBT	WBR	NBL	NBT	NBR	SBL	SBT	SBR
Lane Configurations		↕			↕		↗	↘		↗	↘	
Traffic Volume (vph)	36	125	12	64	200	196	6	552	16	61	515	19
Future Volume (vph)	36	125	12	64	200	196	6	552	16	61	515	19
Ideal Flow (vphpl)	1900	1900	1900	1900	1900	1900	1900	1900	1900	1900	1900	1900
Storage Length (ft)	0		0	0		0	125		0	125		0
Storage Lanes	0		0	0		0	1		0	1		0
Taper Length (ft)	100			100			100			100		
Lane Util. Factor	1.00	1.00	1.00	1.00	1.00	1.00	1.00	1.00	1.00	1.00	1.00	1.00
Frt		0.991			0.942			0.996			0.995	
Flt Protected		0.990			0.993		0.950			0.950		
Satd. Flow (prot)	0	1828	0	0	1742	0	1770	1855	0	1770	1853	0
Flt Permitted		0.791			0.929		0.347			0.169		
Satd. Flow (perm)	0	1460	0	0	1630	0	646	1855	0	315	1853	0
Right Turn on Red			Yes			Yes			Yes			Yes
Satd. Flow (RTOR)		4			44			2			2	
Link Speed (mph)		25			25			35			35	
Link Distance (ft)		82			413			570			1253	
Travel Time (s)		2.2			11.3			11.1			24.4	
Peak Hour Factor	0.90	0.90	0.90	0.90	0.90	0.90	0.90	0.90	0.90	0.90	0.90	0.90
Adj. Flow (vph)	40	139	13	71	222	218	7	613	18	68	572	21
Shared Lane Traffic (%)												
Lane Group Flow (vph)	0	192	0	0	511	0	7	631	0	68	593	0
Enter Blocked Intersection	No	No	No	No	No	No	No	No	No	No	No	No
Lane Alignment	Left	Left	Right	Left	Left	Right	Left	Left	Right	Left	Left	Right
Median Width(ft)		0			0			12			12	
Link Offset(ft)		0			0			0			0	
Crosswalk Width(ft)		16			16			16			16	
Two way Left Turn Lane												
Headway Factor	1.00	1.00	1.00	1.00	1.00	1.00	1.00	1.00	1.00	1.00	1.00	1.00
Turning Speed (mph)	15		9	15		9	15		9	15		9
Number of Detectors	1	2		1	2		1	2		1	2	
Detector Template	Left	Thru		Left	Thru		Left	Thru		Left	Thru	
Leading Detector (ft)	20	100		20	100		20	100		20	100	
Trailing Detector (ft)	0	0		0	0		0	0		0	0	
Detector 1 Position(ft)	0	0		0	0		0	0		0	0	
Detector 1 Size(ft)	20	6		20	6		20	6		20	6	
Detector 1 Type	Cl+Ex	Cl+Ex		Cl+Ex	Cl+Ex		Cl+Ex	Cl+Ex		Cl+Ex	Cl+Ex	
Detector 1 Channel												
Detector 1 Extend (s)	0.0	0.0		0.0	0.0		0.0	0.0		0.0	0.0	
Detector 1 Queue (s)	0.0	0.0		0.0	0.0		0.0	0.0		0.0	0.0	
Detector 1 Delay (s)	0.0	0.0		0.0	0.0		0.0	0.0		0.0	0.0	
Detector 2 Position(ft)		94			94			94			94	
Detector 2 Size(ft)		6			6			6			6	
Detector 2 Type		Cl+Ex			Cl+Ex			Cl+Ex			Cl+Ex	
Detector 2 Channel												
Detector 2 Extend (s)		0.0			0.0			0.0			0.0	
Turn Type	Perm	NA		Perm	NA		pm+pt	NA		pm+pt	NA	
Protected Phases		4			8		5	2		1	6	
Permitted Phases	4			8			2			6		

Lanes, Volumes, Timings
 1: NE Main Street (SC 417) & College Street

Existing (2025) AM
 Burdette North TIS

Lane Group	EBL	EBT	EBR	WBL	WBT	WBR	NBL	NBT	NBR	SBL	SBT	SBR
Detector Phase	4	4		8	8		5	2		1	6	
Switch Phase												
Minimum Initial (s)	7.0	7.0		7.0	7.0		5.0	12.0		5.0	12.0	
Minimum Split (s)	22.5	22.5		22.5	22.5		9.5	22.5		9.5	22.5	
Total Split (s)	43.0	43.0		43.0	43.0		9.6	47.2		9.8	47.4	
Total Split (%)	43.0%	43.0%		43.0%	43.0%		9.6%	47.2%		9.8%	47.4%	
Maximum Green (s)	38.5	38.5		38.5	38.5		5.1	42.7		5.3	42.9	
Yellow Time (s)	3.5	3.5		3.5	3.5		3.5	3.5		3.5	3.5	
All-Red Time (s)	1.0	1.0		1.0	1.0		1.0	1.0		1.0	1.0	
Lost Time Adjust (s)		0.0			0.0		0.0	0.0		0.0	0.0	
Total Lost Time (s)		4.5			4.5		4.5	4.5		4.5	4.5	
Lead/Lag							Lag	Lag		Lead	Lead	
Lead-Lag Optimize?							Yes	Yes		Yes	Yes	
Vehicle Extension (s)	3.0	3.0		3.0	3.0		3.0	3.0		3.0	3.0	
Recall Mode	None	None		None	None		None	C-Max		None	C-Max	
Walk Time (s)	7.0	7.0		7.0	7.0			7.0			7.0	
Flash Don't Walk (s)	11.0	11.0		11.0	11.0			11.0			11.0	
Pedestrian Calls (#/hr)	0	0		0	0			0			0	
Act Effct Green (s)		33.9			33.9		48.7	48.7		55.2	55.2	
Actuated g/C Ratio		0.34			0.34		0.49	0.49		0.55	0.55	
v/c Ratio		0.39			0.88		0.02	0.70		0.26	0.58	
Control Delay (s/veh)		26.0			45.5		14.0	18.4		15.7	19.7	
Queue Delay		0.0			0.0		0.0	0.1		0.0	0.0	
Total Delay (s/veh)		26.0			45.5		14.0	18.5		15.7	19.7	
LOS		C			D		B	B		B	B	
Approach Delay (s/veh)		26.0			45.5			18.5			19.3	
Approach LOS		C			D			B			B	

Intersection Summary

Area Type: Other
 Cycle Length: 100
 Actuated Cycle Length: 100
 Offset: 77 (77%), Referenced to phase 2:NBT and 6:SBTL, Start of Green
 Natural Cycle: 70
 Control Type: Actuated-Coordinated
 Maximum v/c Ratio: 0.88
 Intersection Signal Delay (s/veh): 26.4 Intersection LOS: C
 Intersection Capacity Utilization 76.8% ICU Level of Service D
 Analysis Period (min) 15

Splits and Phases: 1: NE Main Street (SC 417) & College Street

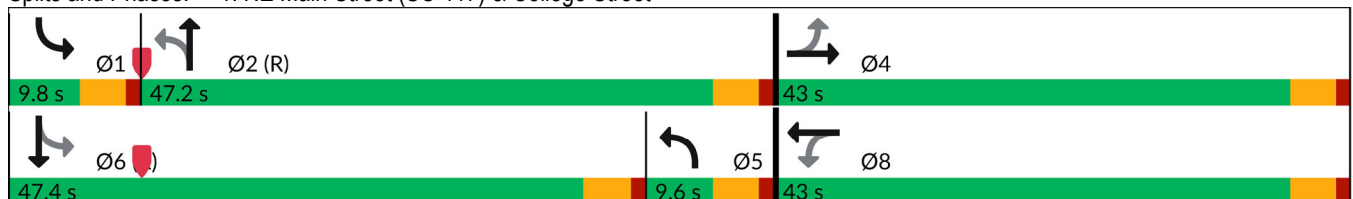

Lanes, Volumes, Timings
 2: NE Main Street (SC 417) & Curtis Street

Existing (2025) AM
 Burdette North TIS



Lane Group	EBL	EBT	EBR	WBL	WBT	WBR	NBL	NBT	NBR	SBL	SBT	SBR
Lane Configurations		↔			↔		↗	↘		↗	↘	
Traffic Volume (vph)	25	189	13	51	235	122	22	410	43	118	442	21
Future Volume (vph)	25	189	13	51	235	122	22	410	43	118	442	21
Ideal Flow (vphpl)	1900	1900	1900	1900	1900	1900	1900	1900	1900	1900	1900	1900
Storage Length (ft)	0		0	0		0	150		0	150		0
Storage Lanes	0		0	0		0	1		0	1		0
Taper Length (ft)	100			100			100			100		
Lane Util. Factor	1.00	1.00	1.00	1.00	1.00	1.00	1.00	1.00	1.00	1.00	1.00	1.00
Frt		0.992			0.960			0.986			0.993	
Flt Protected		0.994			0.994		0.950			0.950		
Satd. Flow (prot)	0	1837	0	0	1778	0	1770	1837	0	1770	1850	0
Flt Permitted		0.898			0.918		0.391			0.289		
Satd. Flow (perm)	0	1659	0	0	1642	0	728	1837	0	538	1850	0
Right Turn on Red			Yes			Yes			Yes			Yes
Satd. Flow (RTOR)		3			25			6			3	
Link Speed (mph)		25			25			35			35	
Link Distance (ft)		85			379			1084			570	
Travel Time (s)		2.3			10.3			21.1			11.1	
Peak Hour Factor	0.90	0.90	0.90	0.90	0.90	0.90	0.90	0.90	0.90	0.90	0.90	0.90
Adj. Flow (vph)	28	210	14	57	261	136	24	456	48	131	491	23
Shared Lane Traffic (%)												
Lane Group Flow (vph)	0	252	0	0	454	0	24	504	0	131	514	0
Enter Blocked Intersection	No	No	No	No	No	No	No	No	No	No	No	No
Lane Alignment	Left	Left	Right	Left	Left	Right	Left	Left	Right	Left	Left	Right
Median Width(ft)		0			0			12			12	
Link Offset(ft)		0			0			0			0	
Crosswalk Width(ft)		16			16			16			16	
Two way Left Turn Lane												
Headway Factor	1.00	1.00	1.00	1.00	1.00	1.00	1.00	1.00	1.00	1.00	1.00	1.00
Turning Speed (mph)	15		9	15		9	15		9	15		9
Number of Detectors	1	2		1	2		1	2		1	2	
Detector Template	Left	Thru		Left	Thru		Left	Thru		Left	Thru	
Leading Detector (ft)	20	100		20	100		20	100		20	100	
Trailing Detector (ft)	0	0		0	0		0	0		0	0	
Detector 1 Position(ft)	0	0		0	0		0	0		0	0	
Detector 1 Size(ft)	20	6		20	6		20	6		20	6	
Detector 1 Type	Cl+Ex	Cl+Ex		Cl+Ex	Cl+Ex		Cl+Ex	Cl+Ex		Cl+Ex	Cl+Ex	
Detector 1 Channel												
Detector 1 Extend (s)	0.0	0.0		0.0	0.0		0.0	0.0		0.0	0.0	
Detector 1 Queue (s)	0.0	0.0		0.0	0.0		0.0	0.0		0.0	0.0	
Detector 1 Delay (s)	0.0	0.0		0.0	0.0		0.0	0.0		0.0	0.0	
Detector 2 Position(ft)		94			94			94			94	
Detector 2 Size(ft)		6			6			6			6	
Detector 2 Type		Cl+Ex			Cl+Ex			Cl+Ex			Cl+Ex	
Detector 2 Channel												
Detector 2 Extend (s)		0.0			0.0			0.0			0.0	
Turn Type	Perm	NA		Perm	NA		pm+pt	NA		pm+pt	NA	
Protected Phases		4			8		5	2		1	6	
Permitted Phases	4			8			2			6		

Lanes, Volumes, Timings
2: NE Main Street (SC 417) & Curtis Street

Existing (2025) AM
Burdette North TIS

Lane Group	EBL	EBT	EBR	WBL	WBT	WBR	NBL	NBT	NBR	SBL	SBT	SBR
Detector Phase	4	4		8	8		5	2		1	6	
Switch Phase												
Minimum Initial (s)	7.0	7.0		7.0	7.0		5.0	12.0		5.0	12.0	
Minimum Split (s)	22.5	22.5		22.5	22.5		9.5	22.5		9.5	22.5	
Total Split (s)	42.0	42.0		42.0	42.0		9.6	45.0		13.0	48.4	
Total Split (%)	42.0%	42.0%		42.0%	42.0%		9.6%	45.0%		13.0%	48.4%	
Maximum Green (s)	37.5	37.5		37.5	37.5		5.1	40.5		8.5	43.9	
Yellow Time (s)	3.5	3.5		3.5	3.5		3.5	3.5		3.5	3.5	
All-Red Time (s)	1.0	1.0		1.0	1.0		1.0	1.0		1.0	1.0	
Lost Time Adjust (s)		0.0			0.0		0.0	0.0		0.0	0.0	
Total Lost Time (s)		4.5			4.5		4.5	4.5		4.5	4.5	
Lead/Lag							Lead	Lag		Lead	Lag	
Lead-Lag Optimize?							Yes	Yes		Yes	Yes	
Vehicle Extension (s)	3.0	3.0		3.0	3.0		3.0	3.0		3.0	3.0	
Recall Mode	None	None		None	None		None	C-Max		None	C-Max	
Walk Time (s)	7.0	7.0		7.0	7.0			7.0			7.0	
Flash Don't Walk (s)	11.0	11.0		11.0	11.0			11.0			11.0	
Pedestrian Calls (#/hr)	0	0		0	0			0			0	
Act Effct Green (s)		31.0			31.0		53.0	47.3		59.6	55.9	
Actuated g/C Ratio		0.31			0.31		0.53	0.47		0.60	0.56	
v/c Ratio		0.49			0.86		0.05	0.58		0.31	0.50	
Control Delay (s/veh)		30.0			29.0		10.7	24.0		5.5	7.0	
Queue Delay		0.0			0.6		0.0	0.1		0.0	0.1	
Total Delay (s/veh)		30.0			29.5		10.7	24.1		5.5	7.1	
LOS		C			C		B	C		A	A	
Approach Delay (s/veh)		30.0			29.5			23.5			6.8	
Approach LOS		C			C			C			A	

Intersection Summary

Area Type: Other
 Cycle Length: 100
 Actuated Cycle Length: 100
 Offset: 80 (80%), Referenced to phase 2:NBTL and 6:SBTL, Start of Green
 Natural Cycle: 60
 Control Type: Actuated-Coordinated
 Maximum v/c Ratio: 0.86
 Intersection Signal Delay (s/veh): 20.1 Intersection LOS: C
 Intersection Capacity Utilization 73.2% ICU Level of Service D
 Analysis Period (min) 15

Splits and Phases: 2: NE Main Street (SC 417) & Curtis Street

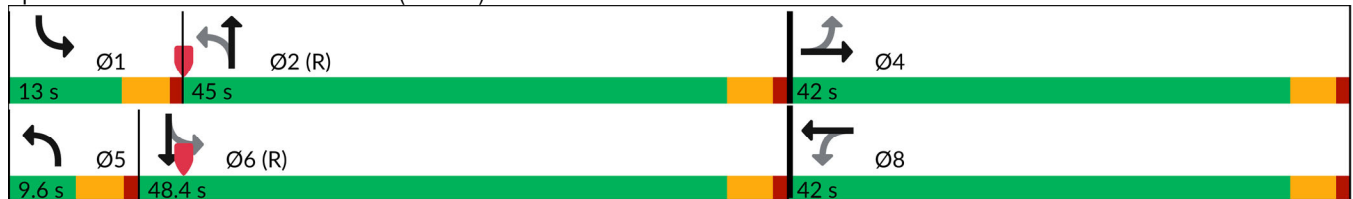

Lanes, Volumes, Timings
 3: Hedge Street & College Street

Existing (2025) AM
 Burdette North TIS

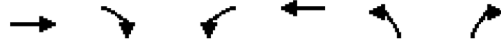

Lane Group	EBT	EBR	WBL	WBT	NBL	NBR
Lane Configurations						
Traffic Volume (vph)	153	47	117	442	12	54
Future Volume (vph)	153	47	117	442	12	54
Ideal Flow (vphp)	1900	1900	1900	1900	1900	1900
Lane Util. Factor	1.00	1.00	1.00	1.00	1.00	1.00
Frt	0.968			0.889		
Flt Protected				0.990	0.991	
Satd. Flow (prot)	1803	0	0	1844	1641	0
Flt Permitted				0.990	0.991	
Satd. Flow (perm)	1803	0	0	1844	1641	0
Link Speed (mph)	25			25	25	
Link Distance (ft)	413			1158	568	
Travel Time (s)	11.3			31.6	15.5	
Peak Hour Factor	0.90	0.90	0.90	0.90	0.90	0.90
Adj. Flow (vph)	170	52	130	491	13	60
Shared Lane Traffic (%)						
Lane Group Flow (vph)	222	0	0	621	73	0
Enter Blocked Intersection	No	No	No	No	No	No
Lane Alignment	Left	Right	Left	Left	Left	Right
Median Width(ft)	0			0	12	
Link Offset(ft)	0			0	0	
Crosswalk Width(ft)	16			16	16	
Two way Left Turn Lane						
Headway Factor	1.00	1.00	1.00	1.00	1.00	1.00
Turning Speed (mph)	9		15	15		9
Sign Control	Free			Free	Stop	

Intersection Summary

Area Type:	Other
Control Type:	Unsignalized
Intersection Capacity Utilization	54.6%
Analysis Period (min)	15
	ICU Level of Service A

Intersection						
Int Delay, s/veh	2.1					
Movement	EBT	EBR	WBL	WBT	NBL	NBR
Lane Configurations	↑			↑	↑	
Traffic Vol, veh/h	153	47	117	442	12	54
Future Vol, veh/h	153	47	117	442	12	54
Conflicting Peds, #/hr	0	0	0	0	0	0
Sign Control	Free	Free	Free	Free	Stop	Stop
RT Channelized	-	None	-	None	-	None
Storage Length	-	-	-	-	0	-
Veh in Median Storage, #	0	-	-	0	0	-
Grade, %	0	-	-	0	0	-
Peak Hour Factor	90	90	90	90	90	90
Heavy Vehicles, %	2	2	2	2	2	2
Mvmt Flow	170	52	130	491	13	60

















Major/Minor	Major1	Major2	Minor1		
Conflicting Flow All	0	0	222	0	947
Stage 1	-	-	-	-	196
Stage 2	-	-	-	-	751
Critical Hdwy	-	-	4.12	-	6.42
Critical Hdwy Stg 1	-	-	-	-	5.42
Critical Hdwy Stg 2	-	-	-	-	5.42
Follow-up Hdwy	-	-	2.218	-	3.518
Pot Cap-1 Maneuver	-	-	1347	-	290
Stage 1	-	-	-	-	837
Stage 2	-	-	-	-	466
Platoon blocked, %	-	-	-	-	-
Mov Cap-1 Maneuver	-	-	1347	-	251
Mov Cap-2 Maneuver	-	-	-	-	251
Stage 1	-	-	-	-	837
Stage 2	-	-	-	-	404

Approach	EB	WB	NB
HCM Ctrl Dly, s/v	0	1.7	12
HCM LOS			B

Minor Lane/Major Mvmt	NBLn1	EBT	EBR	WBL	WBT
Capacity (veh/h)	591	-	-	1347	-
HCM Lane V/C Ratio	0.124	-	-	0.097	-
HCM Ctrl Dly (s/v)	12	-	-	8	0
HCM Lane LOS	B	-	-	A	A
HCM 95th %tile Q (veh)	0.4	-	-	0.3	-

Lanes, Volumes, Timings
4: Hedge Street & Curtis Street

Existing (2025) AM
Burdette North TIS

												
Lane Group	EBL	EBT	EBR	WBL	WBT	WBR	NBL	NBT	NBR	SBL	SBT	SBR
Lane Configurations												
Traffic Volume (vph)	4	319	4	72	397	12	7	73	129	35	145	4
Future Volume (vph)	4	319	4	72	397	12	7	73	129	35	145	4
Ideal Flow (vphpl)	1900	1900	1900	1900	1900	1900	1900	1900	1900	1900	1900	1900
Lane Util. Factor	1.00	1.00	1.00	1.00	1.00	1.00	1.00	1.00	1.00	1.00	1.00	1.00
Fr _t		0.999			0.997			0.917			0.997	
Fl _t Protected		0.999			0.993			0.998			0.991	
Satd. Flow (prot)	0	1859	0	0	1844	0	0	1705	0	0	1840	0
Fl _t Permitted		0.996			0.890			0.998			0.991	
Satd. Flow (perm)	0	1853	0	0	1653	0	0	1705	0	0	1840	0
Right Turn on Red			Yes			Yes			Yes			Yes
Satd. Flow (RTOR)		1			2			72			1	
Link Speed (mph)		25			25			25			25	
Link Distance (ft)		379			1213			1024			568	
Travel Time (s)		10.3			33.1			27.9			15.5	
Peak Hour Factor	0.90	0.90	0.90	0.90	0.90	0.90	0.90	0.90	0.90	0.90	0.90	0.90
Adj. Flow (vph)	4	354	4	80	441	13	8	81	143	39	161	4
Shared Lane Traffic (%)												
Lane Group Flow (vph)	0	362	0	0	534	0	0	232	0	0	204	0
Enter Blocked Intersection	No	No	No	No	No	No	No	No	No	No	No	No
Lane Alignment	Left	Left	Right	Left	Left	Right	Left	Left	Right	Left	Left	Right
Median Width(ft)		0			0			0			0	
Link Offset(ft)		0			0			0			0	
Crosswalk Width(ft)		16			16			16			16	
Two way Left Turn Lane												
Headway Factor	1.00	1.00	1.00	1.00	1.00	1.00	1.00	1.00	1.00	1.00	1.00	1.00
Turning Speed (mph)	15		9	15		9	15		9	15		9
Number of Detectors	1	2		1	0		1	1		1	1	
Detector Template	Left	Thru		Left			Left			Left		
Leading Detector (ft)	20	100		20	0		20	30		20	30	
Trailing Detector (ft)	0	0		0	0		0	0		0	0	
Detector 1 Position(ft)	0	0		0	0		0	0		0	0	
Detector 1 Size(ft)	20	6		20	6		20	30		20	30	
Detector 1 Type	Cl+Ex	Cl+Ex		Cl+Ex	Cl+Ex		Cl+Ex	Cl+Ex		Cl+Ex	Cl+Ex	
Detector 1 Channel												
Detector 1 Extend (s)	0.0	0.0		0.0	0.0		0.0	0.0		0.0	0.0	
Detector 1 Queue (s)	0.0	0.0		0.0	0.0		0.0	0.0		0.0	0.0	
Detector 1 Delay (s)	0.0	0.0		0.0	0.0		0.0	0.0		0.0	0.0	
Detector 2 Position(ft)		94										
Detector 2 Size(ft)		6										
Detector 2 Type		Cl+Ex										
Detector 2 Channel												
Detector 2 Extend (s)		0.0										
Turn Type	Perm	NA		Perm	NA		Split	NA		Split	NA	
Protected Phases		2			6		4	4		8	8	
Permitted Phases	2			6								
Detector Phase	2	2		6	6		4	4		8	8	
Switch Phase												
Minimum Initial (s)	7.0	7.0		7.0	7.0		7.0	7.0		7.0	7.0	

Lanes, Volumes, Timings
4: Hedge Street & Curtis Street

Existing (2025) AM
Burdette North TIS

Lane Group	EBL	EBT	EBR	WBL	WBT	WBR	NBL	NBT	NBR	SBL	SBT	SBR
Minimum Split (s)	22.5	22.5		22.5	22.5		22.5	22.5		22.5	22.5	
Total Split (s)	52.2	52.2		52.2	52.2		24.2	24.2		23.6	23.6	
Total Split (%)	52.2%	52.2%		52.2%	52.2%		24.2%	24.2%		23.6%	23.6%	
Maximum Green (s)	47.7	47.7		47.7	47.7		19.7	19.7		19.1	19.1	
Yellow Time (s)	3.5	3.5		3.5	3.5		3.5	3.5		3.5	3.5	
All-Red Time (s)	1.0	1.0		1.0	1.0		1.0	1.0		1.0	1.0	
Lost Time Adjust (s)		0.0			0.0			0.0			0.0	
Total Lost Time (s)		4.5			4.5			4.5			4.5	
Lead/Lag												
Lead-Lag Optimize?												
Vehicle Extension (s)	3.0	3.0		3.0	3.0		3.0	3.0		3.0	3.0	
Recall Mode	C-Max	C-Max		Max	Max		None	None		None	None	
Walk Time (s)	7.0	7.0		7.0	7.0		7.0	7.0		7.0	7.0	
Flash Don't Walk (s)	11.0	11.0		11.0	11.0		11.0	11.0		11.0	11.0	
Pedestrian Calls (#/hr)	0	0		0	0		0	0		0	0	
Act Effct Green (s)		56.3			56.3			14.6			15.6	
Actuated g/C Ratio		0.56			0.56			0.15			0.16	
v/c Ratio		0.35			0.57			0.75			0.71	
Control Delay (s/veh)		8.3			19.0			42.7			50.8	
Queue Delay		0.5			0.1			0.0			0.0	
Total Delay (s/veh)		8.8			19.1			42.7			50.8	
LOS		A			B			D			D	
Approach Delay (s/veh)		8.8			19.1			42.7			50.8	
Approach LOS		A			B			D			D	

Intersection Summary





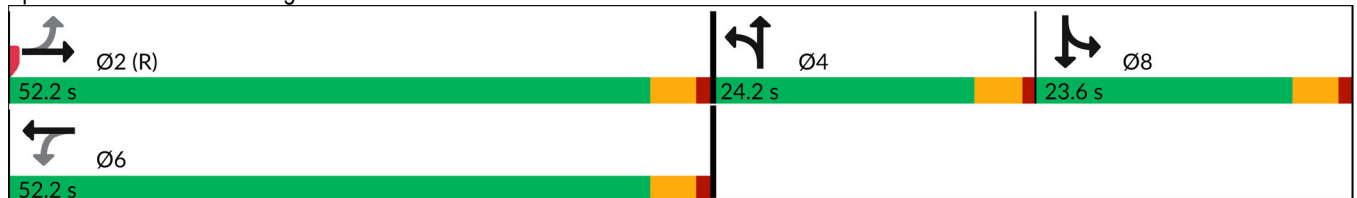











Area Type:	Other
Cycle Length:	100
Actuated Cycle Length:	100
Offset:	6 (6%), Referenced to phase 2:EBTL, Start of Green
Natural Cycle:	80
Control Type:	Actuated-Coordinated
Maximum v/c Ratio:	0.75
Intersection Signal Delay (s/veh):	25.3
Intersection LOS:	C
Intersection Capacity Utilization:	78.4%
ICU Level of Service:	D
Analysis Period (min):	15

Splits and Phases: 4: Hedge Street & Curtis Street



Lanes, Volumes, Timings
5: Main Street & College Street

Existing (2025) AM
Burdette North TIS

												
Lane Group	EBL	EBT	EBR	WBL	WBT	WBR	NBL	NBT	NBR	SBL	SBT	SBR
Lane Configurations												
Traffic Volume (vph)	5	165	1	4	212	9	0	0	7	1	0	21
Future Volume (vph)	5	165	1	4	212	9	0	0	7	1	0	21
Ideal Flow (vphpl)	1900	1900	1900	1900	1900	1900	1900	1900	1900	1900	1900	1900
Lane Util. Factor	1.00	1.00	1.00	1.00	1.00	1.00	1.00	1.00	1.00	1.00	1.00	1.00
Frt		0.999			0.995			0.865			0.871	
Flt Protected		0.998			0.999						0.998	
Satd. Flow (prot)	0	1857	0	0	1852	0	0	1611	0	0	1619	0
Flt Permitted		0.998			0.999						0.998	
Satd. Flow (perm)	0	1857	0	0	1852	0	0	1611	0	0	1619	0
Link Speed (mph)		25			25			25			25	
Link Distance (ft)		1082			82			565			1260	
Travel Time (s)		29.5			2.2			15.4			34.4	
Peak Hour Factor	0.90	0.90	0.90	0.90	0.90	0.90	0.90	0.90	0.90	0.90	0.90	0.90
Adj. Flow (vph)	6	183	1	4	236	10	0	0	8	1	0	23
Shared Lane Traffic (%)												
Lane Group Flow (vph)	0	190	0	0	250	0	0	8	0	0	24	0
Enter Blocked Intersection	No	No	No	No	No	No	No	No	No	No	No	No
Lane Alignment	Left	Left	Right	Left	Left	Right	Left	Left	Right	Left	Left	Right
Median Width(ft)		0			0			0			0	
Link Offset(ft)		0			0			0			0	
Crosswalk Width(ft)		16			16			16			16	
Two way Left Turn Lane												
Headway Factor	1.00	1.00	1.00	1.00	1.00	1.00	1.00	1.00	1.00	1.00	1.00	1.00
Turning Speed (mph)	15		9	15		9	15		9	15		9
Sign Control		Free			Free			Stop			Stop	

Intersection Summary

Area Type:	Other
Control Type:	Unsignalized
Intersection Capacity Utilization	23.4%
Analysis Period (min)	15
	ICU Level of Service A

Intersection												
Int Delay, s/veh	0.8											
Movement	EBL	EBT	EBR	WBL	WBT	WBR	NBL	NBT	NBR	SBL	SBT	SBR
Lane Configurations		↕			↕			↕			↕	
Traffic Vol, veh/h	5	165	1	4	212	9	0	0	7	1	0	21
Future Vol, veh/h	5	165	1	4	212	9	0	0	7	1	0	21
Conflicting Peds, #/hr	0	0	0	0	0	0	0	0	0	0	0	0
Sign Control	Free	Free	Free	Free	Free	Free	Stop	Stop	Stop	Stop	Stop	Stop
RT Channelized	-	-	None	-	-	None	-	-	None	-	-	None
Storage Length	-	-	-	-	-	-	-	-	-	-	-	-
Veh in Median Storage, #	-	0	-	-	0	-	-	0	-	-	0	-
Grade, %	-	0	-	-	0	-	-	0	-	-	0	-
Peak Hour Factor	90	90	90	90	90	90	90	90	90	90	90	90
Heavy Vehicles, %	2	2	2	2	2	2	2	2	2	2	2	2
Mvmt Flow	6	183	1	4	236	10	0	0	8	1	0	23

















Major/Minor	Major1			Major2			Minor1			Minor2		
Conflicting Flow All	246	0	0	184	0	0	457	450	184	449	445	241
Stage 1	-	-	-	-	-	-	196	196	-	249	249	-
Stage 2	-	-	-	-	-	-	261	254	-	200	196	-
Critical Hdwy	4.12	-	-	4.12	-	-	7.12	6.52	6.22	7.12	6.52	6.22
Critical Hdwy Stg 1	-	-	-	-	-	-	6.12	5.52	-	6.12	5.52	-
Critical Hdwy Stg 2	-	-	-	-	-	-	6.12	5.52	-	6.12	5.52	-
Follow-up Hdwy	2.218	-	-	2.218	-	-	3.518	4.018	3.318	3.518	4.018	3.318
Pot Cap-1 Maneuver	1320	-	-	1391	-	-	514	504	858	520	508	798
Stage 1	-	-	-	-	-	-	806	739	-	755	701	-
Stage 2	-	-	-	-	-	-	744	697	-	802	739	-
Platoon blocked, %		-	-		-	-						
Mov Cap-1 Maneuver	1320	-	-	1391	-	-	496	500	858	512	504	798
Mov Cap-2 Maneuver	-	-	-	-	-	-	496	500	-	512	504	-
Stage 1	-	-	-	-	-	-	802	735	-	751	699	-
Stage 2	-	-	-	-	-	-	720	695	-	791	735	-

Approach	EB			WB			NB			SB		
HCM Ctrl Dly, s/v	0.2			0.1			9.2			9.8		
HCM LOS							A			A		

Minor Lane/Major Mvmt	NBLn1	EBL	EBT	EBR	WBL	WBT	WBR	SBLn1
Capacity (veh/h)	858	1320	-	-	1391	-	-	778
HCM Lane V/C Ratio	0.009	0.004	-	-	0.003	-	-	0.031
HCM Ctrl Dly (s/v)	9.2	7.7	0	-	7.6	0	-	9.8
HCM Lane LOS	A	A	A	-	A	A	-	A
HCM 95th %tile Q (veh)	0	0	-	-	0	-	-	0.1

Lanes, Volumes, Timings
6: Main Street & Curtis Street

Existing (2025) AM
Burdette North TIS

												
Lane Group	EBL	EBT	EBR	WBL	WBT	WBR	NBL	NBT	NBR	SBL	SBT	SBR
Lane Configurations												
Traffic Volume (vph)	1	214	11	13	257	8	14	0	12	1	0	16
Future Volume (vph)	1	214	11	13	257	8	14	0	12	1	0	16
Ideal Flow (vphpl)	1900	1900	1900	1900	1900	1900	1900	1900	1900	1900	1900	1900
Lane Util. Factor	1.00	1.00	1.00	1.00	1.00	1.00	1.00	1.00	1.00	1.00	1.00	1.00
Fr _t		0.994			0.996			0.939			0.872	
Fl _t Protected					0.998			0.973			0.997	
Satd. Flow (prot)	0	1852	0	0	1852	0	0	1702	0	0	1619	0
Fl _t Permitted					0.998			0.973			0.997	
Satd. Flow (perm)	0	1852	0	0	1852	0	0	1702	0	0	1619	0
Link Speed (mph)		25			25			25			25	
Link Distance (ft)		1197			85			1027			565	
Travel Time (s)		32.6			2.3			28.0			15.4	
Peak Hour Factor	0.90	0.90	0.90	0.90	0.90	0.90	0.90	0.90	0.90	0.90	0.90	0.90
Adj. Flow (vph)	1	238	12	14	286	9	16	0	13	1	0	18
Shared Lane Traffic (%)												
Lane Group Flow (vph)	0	251	0	0	309	0	0	29	0	0	19	0
Enter Blocked Intersection	No	No	No	No	No	No	No	No	No	No	No	No
Lane Alignment	Left	Left	Right	Left	Left	Right	Left	Left	Right	Left	Left	Right
Median Width(ft)		0			0			0			0	
Link Offset(ft)		0			0			0			0	
Crosswalk Width(ft)		16			16			16			16	
Two way Left Turn Lane												
Headway Factor	1.00	1.00	1.00	1.00	1.00	1.00	1.00	1.00	1.00	1.00	1.00	1.00
Turning Speed (mph)	15		9	15		9	15		9	15		9
Sign Control		Free			Free			Stop			Stop	

Intersection Summary	
Area Type:	Other
Control Type:	Unsignalized
Intersection Capacity Utilization	37.0%
Analysis Period (min)	15
	ICU Level of Service A

Intersection												
Int Delay, s/veh	1.1											
Movement	EBL	EBT	EBR	WBL	WBT	WBR	NBL	NBT	NBR	SBL	SBT	SBR
Lane Configurations		↕			↕			↕			↕	
Traffic Vol, veh/h	1	214	11	13	257	8	14	0	12	1	0	16
Future Vol, veh/h	1	214	11	13	257	8	14	0	12	1	0	16
Conflicting Peds, #/hr	0	0	0	0	0	0	0	0	0	0	0	0
Sign Control	Free	Free	Free	Free	Free	Free	Stop	Stop	Stop	Stop	Stop	Stop
RT Channelized	-	-	None	-	-	None	-	-	None	-	-	None
Storage Length	-	-	-	-	-	-	-	-	-	-	-	-
Veh in Median Storage, #	-	0	-	-	0	-	-	0	-	-	0	-
Grade, %	-	0	-	-	0	-	-	0	-	-	0	-
Peak Hour Factor	90	90	90	90	90	90	90	90	90	90	90	90
Heavy Vehicles, %	2	2	2	2	2	2	2	2	2	2	2	2
Mvmt Flow	1	238	12	14	286	9	16	0	13	1	0	18

Major/Minor	Major1			Major2			Minor1			Minor2		
Conflicting Flow All	295	0	0	250	0	0	574	569	244	572	571	291
Stage 1	-	-	-	-	-	-	246	246	-	319	319	-
Stage 2	-	-	-	-	-	-	328	323	-	253	252	-
Critical Hdwy	4.12	-	-	4.12	-	-	7.12	6.52	6.22	7.12	6.52	6.22
Critical Hdwy Stg 1	-	-	-	-	-	-	6.12	5.52	-	6.12	5.52	-
Critical Hdwy Stg 2	-	-	-	-	-	-	6.12	5.52	-	6.12	5.52	-
Follow-up Hdwy	2.218	-	-	2.218	-	-	3.518	4.018	3.318	3.518	4.018	3.318
Pot Cap-1 Maneuver	1266	-	-	1316	-	-	430	432	795	431	431	748
Stage 1	-	-	-	-	-	-	758	703	-	693	653	-
Stage 2	-	-	-	-	-	-	685	650	-	751	698	-
Platoon blocked, %		-	-		-	-						
Mov Cap-1 Maneuver	1266	-	-	1316	-	-	415	426	795	419	425	748
Mov Cap-2 Maneuver	-	-	-	-	-	-	415	426	-	419	425	-
Stage 1	-	-	-	-	-	-	757	702	-	692	645	-
Stage 2	-	-	-	-	-	-	660	642	-	738	697	-

Approach	EB			WB			NB			SB		
HCM Ctrl Dly, s/v	0			0.4			12.2			10.2		
HCM LOS							B			B		

Minor Lane/Major Mvmt	NBLn1	EBL	EBT	EBR	WBL	WBT	WBR	SBLn1
Capacity (veh/h)	532	1266	-	-	1316	-	-	715
HCM Lane V/C Ratio	0.054	0.001	-	-	0.011	-	-	0.026
HCM Ctrl Dly (s/v)	12.2	7.8	0	-	7.8	0	-	10.2
HCM Lane LOS	B	A	A	-	A	A	-	B
HCM 95th %tile Q (veh)	0.2	0	-	-	0	-	-	0.1

Lanes, Volumes, Timings
 1: NE Main Street (SC 417) & College Street

Existing (2025) PM
 Burdette North TIS



Lane Group	EBL	EBT	EBR	WBL	WBT	WBR	NBL	NBT	NBR	SBL	SBT	SBR
Lane Configurations		↔			↔		↗	↘		↗	↘	
Traffic Volume (vph)	33	177	27	42	160	103	12	498	72	123	663	22
Future Volume (vph)	33	177	27	42	160	103	12	498	72	123	663	22
Ideal Flow (vphpl)	1900	1900	1900	1900	1900	1900	1900	1900	1900	1900	1900	1900
Storage Length (ft)	0		0	0		0	125		0	125		0
Storage Lanes	0		0	0		0	1		0	1		0
Taper Length (ft)	100			100			100			100		
Lane Util. Factor	1.00	1.00	1.00	1.00	1.00	1.00	1.00	1.00	1.00	1.00	1.00	1.00
Frt		0.985			0.955			0.981			0.995	
Flt Protected		0.993			0.993		0.950			0.950		
Satd. Flow (prot)	0	1822	0	0	1766	0	1770	1827	0	1770	1853	0
Flt Permitted		0.832			0.867		0.262			0.249		
Satd. Flow (perm)	0	1527	0	0	1542	0	488	1827	0	464	1853	0
Right Turn on Red			Yes			Yes			Yes			Yes
Satd. Flow (RTOR)		6			26			10			2	
Link Speed (mph)		25			25			35			35	
Link Distance (ft)		82			413			570			1253	
Travel Time (s)		2.2			11.3			11.1			24.4	
Peak Hour Factor	0.90	0.90	0.90	0.90	0.90	0.90	0.90	0.90	0.90	0.90	0.90	0.90
Adj. Flow (vph)	37	197	30	47	178	114	13	553	80	137	737	24
Shared Lane Traffic (%)												
Lane Group Flow (vph)	0	264	0	0	339	0	13	633	0	137	761	0
Enter Blocked Intersection	No	No	No	No	No	No	No	No	No	No	No	No
Lane Alignment	Left	Left	Right	Left	Left	Right	Left	Left	Right	Left	Left	Right
Median Width(ft)		0			0			12			12	
Link Offset(ft)		0			0			0			0	
Crosswalk Width(ft)		16			16			16			16	
Two way Left Turn Lane												
Headway Factor	1.00	1.00	1.00	1.00	1.00	1.00	1.00	1.00	1.00	1.00	1.00	1.00
Turning Speed (mph)	15		9	15		9	15		9	15		9
Number of Detectors	1	2		1	2		1	2		1	2	
Detector Template	Left	Thru		Left	Thru		Left	Thru		Left	Thru	
Leading Detector (ft)	20	100		20	100		20	100		20	100	
Trailing Detector (ft)	0	0		0	0		0	0		0	0	
Detector 1 Position(ft)	0	0		0	0		0	0		0	0	
Detector 1 Size(ft)	20	6		20	6		20	6		20	6	
Detector 1 Type	Cl+Ex	Cl+Ex		Cl+Ex	Cl+Ex		Cl+Ex	Cl+Ex		Cl+Ex	Cl+Ex	
Detector 1 Channel												
Detector 1 Extend (s)	0.0	0.0		0.0	0.0		0.0	0.0		0.0	0.0	
Detector 1 Queue (s)	0.0	0.0		0.0	0.0		0.0	0.0		0.0	0.0	
Detector 1 Delay (s)	0.0	0.0		0.0	0.0		0.0	0.0		0.0	0.0	
Detector 2 Position(ft)		94			94			94			94	
Detector 2 Size(ft)		6			6			6			6	
Detector 2 Type		Cl+Ex			Cl+Ex			Cl+Ex			Cl+Ex	
Detector 2 Channel												
Detector 2 Extend (s)		0.0			0.0			0.0			0.0	
Turn Type	Perm	NA		Perm	NA		pm+pt	NA		pm+pt	NA	
Protected Phases		4			8		5	2		1	6	
Permitted Phases	4			8			2			6		

Lanes, Volumes, Timings
1: NE Main Street (SC 417) & College Street

Existing (2025) PM
Burdette North TIS

Lane Group	EBL	EBT	EBR	WBL	WBT	WBR	NBL	NBT	NBR	SBL	SBT	SBR
Detector Phase	4	4		8	8		5	2		1	6	
Switch Phase												
Minimum Initial (s)	7.0	7.0		7.0	7.0		5.0	12.0		5.0	12.0	
Minimum Split (s)	22.5	22.5		22.5	22.5		9.5	22.5		9.5	22.5	
Total Split (s)	33.0	33.0		33.0	33.0		9.6	53.8		13.2	57.4	
Total Split (%)	33.0%	33.0%		33.0%	33.0%		9.6%	53.8%		13.2%	57.4%	
Maximum Green (s)	28.5	28.5		28.5	28.5		5.1	49.3		8.7	52.9	
Yellow Time (s)	3.5	3.5		3.5	3.5		3.5	3.5		3.5	3.5	
All-Red Time (s)	1.0	1.0		1.0	1.0		1.0	1.0		1.0	1.0	
Lost Time Adjust (s)		0.0			0.0		0.0	0.0		0.0	0.0	
Total Lost Time (s)		4.5			4.5		4.5	4.5		4.5	4.5	
Lead/Lag							Lead	Lag		Lead	Lag	
Lead-Lag Optimize?							Yes	Yes		Yes	Yes	
Vehicle Extension (s)	3.0	3.0		3.0	3.0		3.0	3.0		3.0	3.0	
Recall Mode	None	None		None	None		None	C-Max		None	C-Max	
Walk Time (s)	7.0	7.0		7.0	7.0			7.0			7.0	
Flash Don't Walk (s)	11.0	11.0		11.0	11.0			11.0			11.0	
Pedestrian Calls (#/hr)	0	0		0	0			0			0	
Act Effct Green (s)		23.8			23.8		60.2	54.8		67.0	65.3	
Actuated g/C Ratio		0.24			0.24		0.60	0.55		0.67	0.65	
v/c Ratio		0.72			0.88		0.04	0.63		0.33	0.63	
Control Delay (s/veh)		45.0			56.8		4.3	9.7		8.9	15.1	
Queue Delay		0.0			0.0		0.0	0.2		0.0	0.0	
Total Delay (s/veh)		45.0			56.8		4.3	9.9		8.9	15.1	
LOS		D			E		A	A		A	B	
Approach Delay (s/veh)		45.0			56.8			9.8			14.2	
Approach LOS		D			E			A			B	

Intersection Summary



















Area Type: Other
 Cycle Length: 100
 Actuated Cycle Length: 100
 Offset: 72 (72%), Referenced to phase 2:NBTL and 6:SBTL, Start of Green
 Natural Cycle: 70
 Control Type: Actuated-Coordinated
 Maximum v/c Ratio: 0.88
 Intersection Signal Delay (s/veh): 23.4 Intersection LOS: C
 Intersection Capacity Utilization 74.3% ICU Level of Service D
 Analysis Period (min) 15

Splits and Phases: 1: NE Main Street (SC 417) & College Street



Lanes, Volumes, Timings
2: NE Main Street (SC 417) & Curtis Street

Existing (2025) PM
Burdette North TIS

												
Lane Group	EBL	EBT	EBR	WBL	WBT	WBR	NBL	NBT	NBR	SBL	SBT	SBR
Lane Configurations												
Traffic Volume (vph)	16	252	21	30	190	54	44	456	136	191	465	51
Future Volume (vph)	16	252	21	30	190	54	44	456	136	191	465	51
Ideal Flow (vphpl)	1900	1900	1900	1900	1900	1900	1900	1900	1900	1900	1900	1900
Storage Length (ft)	0		0	0		0	150		0	150		0
Storage Lanes	0		0	0		0	1		0	1		0
Taper Length (ft)	100			100			100			100		
Lane Util. Factor	1.00	1.00	1.00	1.00	1.00	1.00	1.00	1.00	1.00	1.00	1.00	1.00
Frt		0.990			0.973			0.966			0.985	
Flt Protected		0.997			0.995		0.950			0.950		
Satd. Flow (prot)	0	1839	0	0	1803	0	1770	1799	0	1770	1835	0
Flt Permitted		0.955			0.841		0.375			0.232		
Satd. Flow (perm)	0	1761	0	0	1524	0	699	1799	0	432	1835	0
Right Turn on Red			Yes			Yes			Yes			Yes
Satd. Flow (RTOR)		4			12			21			9	
Link Speed (mph)		25			25			35			35	
Link Distance (ft)		85			379			1084			570	
Travel Time (s)		2.3			10.3			21.1			11.1	
Peak Hour Factor	0.90	0.90	0.90	0.90	0.90	0.90	0.90	0.90	0.90	0.90	0.90	0.90
Adj. Flow (vph)	18	280	23	33	211	60	49	507	151	212	517	57
Shared Lane Traffic (%)												
Lane Group Flow (vph)	0	321	0	0	304	0	49	658	0	212	574	0
Enter Blocked Intersection	No	No	No	No	No	No	No	No	No	No	No	No
Lane Alignment	Left	Left	Right	Left	Left	Right	Left	Left	Right	Left	Left	Right
Median Width(ft)		0			0			12			12	
Link Offset(ft)		0			0			0			0	
Crosswalk Width(ft)		16			16			16			16	
Two way Left Turn Lane												
Headway Factor	1.00	1.00	1.00	1.00	1.00	1.00	1.00	1.00	1.00	1.00	1.00	1.00
Turning Speed (mph)	15		9	15		9	15		9	15		9
Number of Detectors	1	2		1	2		1	2		1	2	
Detector Template	Left	Thru		Left	Thru		Left	Thru		Left	Thru	
Leading Detector (ft)	20	100		20	100		20	100		20	100	
Trailing Detector (ft)	0	0		0	0		0	0		0	0	
Detector 1 Position(ft)	0	0		0	0		0	0		0	0	
Detector 1 Size(ft)	20	6		20	6		20	6		20	6	
Detector 1 Type	Cl+Ex	Cl+Ex		Cl+Ex	Cl+Ex		Cl+Ex	Cl+Ex		Cl+Ex	Cl+Ex	
Detector 1 Channel												
Detector 1 Extend (s)	0.0	0.0		0.0	0.0		0.0	0.0		0.0	0.0	
Detector 1 Queue (s)	0.0	0.0		0.0	0.0		0.0	0.0		0.0	0.0	
Detector 1 Delay (s)	0.0	0.0		0.0	0.0		0.0	0.0		0.0	0.0	
Detector 2 Position(ft)		94			94			94			94	
Detector 2 Size(ft)		6			6			6			6	
Detector 2 Type		Cl+Ex			Cl+Ex			Cl+Ex			Cl+Ex	
Detector 2 Channel												
Detector 2 Extend (s)		0.0			0.0			0.0			0.0	
Turn Type	Perm	NA		Perm	NA		pm+pt	NA		pm+pt	NA	
Protected Phases		4			8		5	2		1	6	
Permitted Phases	4			8			2			6		

Lanes, Volumes, Timings
2: NE Main Street (SC 417) & Curtis Street

Existing (2025) PM
Burdette North TIS

Lane Group	EBL	EBT	EBR	WBL	WBT	WBR	NBL	NBT	NBR	SBL	SBT	SBR
Detector Phase	4	4		8	8		5	2		1	6	
Switch Phase												
Minimum Initial (s)	7.0	7.0		7.0	7.0		5.0	12.0		5.0	12.0	
Minimum Split (s)	22.5	22.5		22.5	22.5		9.5	22.5		9.5	22.5	
Total Split (s)	30.0	30.0		30.0	30.0		9.6	53.0		17.0	60.4	
Total Split (%)	30.0%	30.0%		30.0%	30.0%		9.6%	53.0%		17.0%	60.4%	
Maximum Green (s)	25.5	25.5		25.5	25.5		5.1	48.5		12.5	55.9	
Yellow Time (s)	3.5	3.5		3.5	3.5		3.5	3.5		3.5	3.5	
All-Red Time (s)	1.0	1.0		1.0	1.0		1.0	1.0		1.0	1.0	
Lost Time Adjust (s)		0.0			0.0		0.0	0.0		0.0	0.0	
Total Lost Time (s)		4.5			4.5		4.5	4.5		4.5	4.5	
Lead/Lag							Lead	Lag		Lead	Lag	
Lead-Lag Optimize?							Yes	Yes		Yes	Yes	
Vehicle Extension (s)	3.0	3.0		3.0	3.0		3.0	3.0		3.0	3.0	
Recall Mode	None	None		None	None		None	C-Max		None	C-Max	
Walk Time (s)	7.0	7.0		7.0	7.0			7.0			7.0	
Flash Don't Walk (s)	11.0	11.0		11.0	11.0			11.0			11.0	
Pedestrian Calls (#/hr)	0	0		0	0			0			0	
Act Effct Green (s)		22.0			22.0		60.3	54.7		68.4	60.9	
Actuated g/C Ratio		0.22			0.22		0.60	0.55		0.68	0.61	
v/c Ratio		0.82			0.88		0.10	0.66		0.50	0.51	
Control Delay (s/veh)		54.0			46.7		6.9	21.1		12.0	9.8	
Queue Delay		0.0			0.1		0.0	0.3		0.1	0.2	
Total Delay (s/veh)		54.0			46.8		6.9	21.4		12.1	10.0	
LOS		D			D		A	C		B	B	
Approach Delay (s/veh)		54.0			46.8			20.4			10.6	
Approach LOS		D			D			C			B	

Intersection Summary

Area Type: Other
 Cycle Length: 100
 Actuated Cycle Length: 100
 Offset: 66 (66%), Referenced to phase 2:NBTL and 6:SBTL, Start of Green
 Natural Cycle: 65
 Control Type: Actuated-Coordinated
 Maximum v/c Ratio: 0.88
 Intersection Signal Delay (s/veh): 25.6 Intersection LOS: C
 Intersection Capacity Utilization 77.8% ICU Level of Service D
 Analysis Period (min) 15

Splits and Phases: 2: NE Main Street (SC 417) & Curtis Street



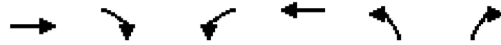

Lane Group	EBT	EBR	WBL	WBT	NBL	NBR
Lane Configurations						
Traffic Volume (vph)	331	133	44	268	9	56
Future Volume (vph)	331	133	44	268	9	56
Ideal Flow (vphp)	1900	1900	1900	1900	1900	1900
Lane Util. Factor	1.00	1.00	1.00	1.00	1.00	1.00
Frt	0.961			0.884		
Flt Protected				0.993	0.993	
Satd. Flow (prot)	1790	0	0	1850	1635	0
Flt Permitted				0.993	0.993	
Satd. Flow (perm)	1790	0	0	1850	1635	0
Link Speed (mph)	25			25	25	
Link Distance (ft)	413			1158	568	
Travel Time (s)	11.3			31.6	15.5	
Peak Hour Factor	0.90	0.90	0.90	0.90	0.90	0.90
Adj. Flow (vph)	368	148	49	298	10	62
Shared Lane Traffic (%)						
Lane Group Flow (vph)	516	0	0	347	72	0
Enter Blocked Intersection	No	No	No	No	No	No
Lane Alignment	Left	Right	Left	Left	Left	Right
Median Width(ft)	0			0	12	
Link Offset(ft)	0			0	0	
Crosswalk Width(ft)	16			16	16	
Two way Left Turn Lane						
Headway Factor	1.00	1.00	1.00	1.00	1.00	1.00
Turning Speed (mph)	9		15	15		9
Sign Control	Free			Free	Stop	

Intersection Summary

Area Type:	Other
Control Type:	Unsignalized
Intersection Capacity Utilization	56.0% ICU Level of Service B
Analysis Period (min)	15

Intersection						
Int Delay, s/veh	1.4					
Movement	EBT	EBR	WBL	WBT	NBL	NBR
Lane Configurations	↑			↑	↑	
Traffic Vol, veh/h	331	133	44	268	9	56
Future Vol, veh/h	331	133	44	268	9	56
Conflicting Peds, #/hr	0	0	0	0	0	0
Sign Control	Free	Free	Free	Free	Stop	Stop
RT Channelized	-	None	-	None	-	None
Storage Length	-	-	-	-	0	-
Veh in Median Storage, #	0	-	-	0	0	-
Grade, %	0	-	-	0	0	-
Peak Hour Factor	90	90	90	90	90	90
Heavy Vehicles, %	2	2	2	2	2	2
Mvmt Flow	368	148	49	298	10	62

















Major/Minor	Major1	Major2	Minor1		
Conflicting Flow All	0	0	516	0	838 442
Stage 1	-	-	-	-	442 -
Stage 2	-	-	-	-	396 -
Critical Hdwy	-	-	4.12	-	6.42 6.22
Critical Hdwy Stg 1	-	-	-	-	5.42 -
Critical Hdwy Stg 2	-	-	-	-	5.42 -
Follow-up Hdwy	-	-	2.218	-	3.518 3.318
Pot Cap-1 Maneuver	-	-	1050	-	336 615
Stage 1	-	-	-	-	648 -
Stage 2	-	-	-	-	680 -
Platoon blocked, %	-	-	-	-	-
Mov Cap-1 Maneuver	-	-	1050	-	317 615
Mov Cap-2 Maneuver	-	-	-	-	317 -
Stage 1	-	-	-	-	648 -
Stage 2	-	-	-	-	642 -

Approach	EB	WB	NB
HCM Ctrl Dly, s/v	0	1.2	12.6
HCM LOS			B

Minor Lane/Major Mvmt	NBLn1	EBT	EBR	WBL	WBT
Capacity (veh/h)	544	-	-	1050	-
HCM Lane V/C Ratio	0.133	-	-	0.047	-
HCM Ctrl Dly (s/v)	12.6	-	-	8.6	0
HCM Lane LOS	B	-	-	A	A
HCM 95th %tile Q (veh)	0.5	-	-	0.1	-

Lanes, Volumes, Timings
4: Hedge Street & Curtis Street

Existing (2025) PM
Burdette North TIS

												
Lane Group	EBL	EBT	EBR	WBL	WBT	WBR	NBL	NBT	NBR	SBL	SBT	SBR
Lane Configurations												
Traffic Volume (vph)	16	542	11	75	275	11	5	78	209	107	67	6
Future Volume (vph)	16	542	11	75	275	11	5	78	209	107	67	6
Ideal Flow (vphpl)	1900	1900	1900	1900	1900	1900	1900	1900	1900	1900	1900	1900
Lane Util. Factor	1.00	1.00	1.00	1.00	1.00	1.00	1.00	1.00	1.00	1.00	1.00	1.00
Fr _t		0.997			0.996			0.904			0.995	
Fl _t Protected		0.999			0.990			0.999			0.971	
Satd. Flow (prot)	0	1855	0	0	1837	0	0	1682	0	0	1800	0
Fl _t Permitted		0.985			0.778			0.999			0.971	
Satd. Flow (perm)	0	1829	0	0	1443	0	0	1682	0	0	1800	0
Right Turn on Red			Yes			Yes			Yes			Yes
Satd. Flow (RTOR)		1			2			114			2	
Link Speed (mph)		25			25			25			25	
Link Distance (ft)		379			1213			1024			568	
Travel Time (s)		10.3			33.1			27.9			15.5	
Peak Hour Factor	0.90	0.90	0.90	0.90	0.90	0.90	0.90	0.90	0.90	0.90	0.90	0.90
Adj. Flow (vph)	18	602	12	83	306	12	6	87	232	119	74	7
Shared Lane Traffic (%)												
Lane Group Flow (vph)	0	632	0	0	401	0	0	325	0	0	200	0
Enter Blocked Intersection	No	No	No	No	No	No	No	No	No	No	No	No
Lane Alignment	Left	Left	Right	Left	Left	Right	Left	Left	Right	Left	Left	Right
Median Width(ft)		0			0			0			0	
Link Offset(ft)		0			0			0			0	
Crosswalk Width(ft)		16			16			16			16	
Two way Left Turn Lane												
Headway Factor	1.00	1.00	1.00	1.00	1.00	1.00	1.00	1.00	1.00	1.00	1.00	1.00
Turning Speed (mph)	15		9	15		9	15		9	15		9
Number of Detectors	1	2		1	0		1	1		1	1	
Detector Template	Left	Thru		Left			Left			Left		
Leading Detector (ft)	20	100		20	0		20	30		20	30	
Trailing Detector (ft)	0	0		0	0		0	0		0	0	
Detector 1 Position(ft)	0	0		0	0		0	0		0	0	
Detector 1 Size(ft)	20	6		20	6		20	30		20	30	
Detector 1 Type	Cl+Ex	Cl+Ex		Cl+Ex	Cl+Ex		Cl+Ex	Cl+Ex		Cl+Ex	Cl+Ex	
Detector 1 Channel												
Detector 1 Extend (s)	0.0	0.0		0.0	0.0		0.0	0.0		0.0	0.0	
Detector 1 Queue (s)	0.0	0.0		0.0	0.0		0.0	0.0		0.0	0.0	
Detector 1 Delay (s)	0.0	0.0		0.0	0.0		0.0	0.0		0.0	0.0	
Detector 2 Position(ft)		94										
Detector 2 Size(ft)		6										
Detector 2 Type		Cl+Ex										
Detector 2 Channel												
Detector 2 Extend (s)		0.0										
Turn Type	Perm	NA		Perm	NA		Split	NA		Split	NA	
Protected Phases		2			6		4	4		8	8	
Permitted Phases	2			6								
Detector Phase	2	2		6	6		4	4		8	8	
Switch Phase												
Minimum Initial (s)	7.0	7.0		7.0	7.0		7.0	7.0		7.0	7.0	

Lanes, Volumes, Timings
4: Hedge Street & Curtis Street

Existing (2025) PM
Burdette North TIS

Lane Group	EBL	EBT	EBR	WBL	WBT	WBR	NBL	NBT	NBR	SBL	SBT	SBR
Minimum Split (s)	22.5	22.5		22.5	22.5		22.5	22.5		22.5	22.5	
Total Split (s)	51.0	51.0		51.0	51.0		26.0	26.0		23.0	23.0	
Total Split (%)	51.0%	51.0%		51.0%	51.0%		26.0%	26.0%		23.0%	23.0%	
Maximum Green (s)	46.5	46.5		46.5	46.5		21.5	21.5		18.5	18.5	
Yellow Time (s)	3.5	3.5		3.5	3.5		3.5	3.5		3.5	3.5	
All-Red Time (s)	1.0	1.0		1.0	1.0		1.0	1.0		1.0	1.0	
Lost Time Adjust (s)		0.0			0.0			0.0			0.0	
Total Lost Time (s)		4.5			4.5			4.5			4.5	
Lead/Lag												
Lead-Lag Optimize?												
Vehicle Extension (s)	3.0	3.0		3.0	3.0		3.0	3.0		3.0	3.0	
Recall Mode	C-Max	C-Max		Max	Max		None	None		None	None	
Walk Time (s)	7.0	7.0		7.0	7.0		7.0	7.0		7.0	7.0	
Flash Don't Walk (s)	11.0	11.0		11.0	11.0		11.0	11.0		11.0	11.0	
Pedestrian Calls (#/hr)	0	0		0	0		0	0		0	0	
Act Effct Green (s)		53.6			53.6			17.4			15.4	
Actuated g/C Ratio		0.54			0.54			0.17			0.15	
v/c Ratio		0.64			0.52			0.84			0.72	
Control Delay (s/veh)		16.0			19.8			44.6			51.3	
Queue Delay		1.2			0.0			0.0			0.0	
Total Delay (s/veh)		17.2			19.8			44.6			51.3	
LOS		B			B			D			D	
Approach Delay (s/veh)		17.2			19.8			44.6			51.3	
Approach LOS		B			B			D			D	

Intersection Summary





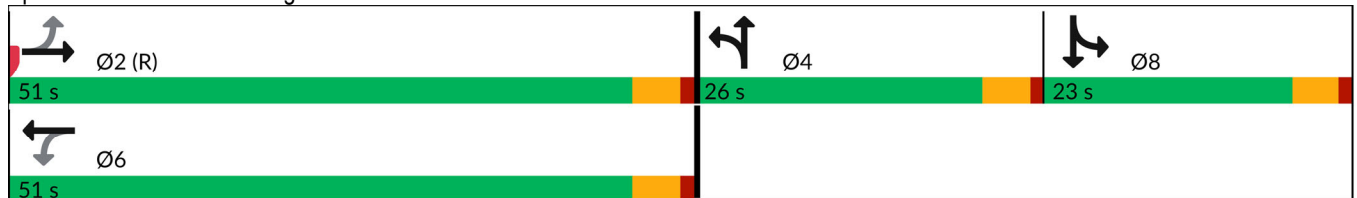











Area Type:	Other
Cycle Length:	100
Actuated Cycle Length:	100
Offset:	8 (8%), Referenced to phase 2:EBTL, Start of Green
Natural Cycle:	80
Control Type:	Actuated-Coordinated
Maximum v/c Ratio:	0.84
Intersection Signal Delay (s/veh):	27.9
Intersection LOS:	C
Intersection Capacity Utilization:	91.4%
ICU Level of Service:	F
Analysis Period (min):	15

Splits and Phases: 4: Hedge Street & Curtis Street



Lanes, Volumes, Timings
5: Main Street & College Street

Existing (2025) PM
Burdette North TIS

												
Lane Group	EBL	EBT	EBR	WBL	WBT	WBR	NBL	NBT	NBR	SBL	SBT	SBR
Lane Configurations												
Traffic Volume (vph)	3	217	2	15	175	4	4	0	6	14	0	28
Future Volume (vph)	3	217	2	15	175	4	4	0	6	14	0	28
Ideal Flow (vphpl)	1900	1900	1900	1900	1900	1900	1900	1900	1900	1900	1900	1900
Lane Util. Factor	1.00	1.00	1.00	1.00	1.00	1.00	1.00	1.00	1.00	1.00	1.00	1.00
Frt		0.999			0.997			0.914			0.911	
Flt Protected		0.999			0.996			0.982			0.983	
Satd. Flow (prot)	0	1859	0	0	1850	0	0	1672	0	0	1668	0
Flt Permitted		0.999			0.996			0.982			0.983	
Satd. Flow (perm)	0	1859	0	0	1850	0	0	1672	0	0	1668	0
Link Speed (mph)		25			25			25			25	
Link Distance (ft)		1082			82			565			1260	
Travel Time (s)		29.5			2.2			15.4			34.4	
Peak Hour Factor	0.90	0.90	0.90	0.90	0.90	0.90	0.90	0.90	0.90	0.90	0.90	0.90
Adj. Flow (vph)	3	241	2	17	194	4	4	0	7	16	0	31
Shared Lane Traffic (%)												
Lane Group Flow (vph)	0	246	0	0	215	0	0	11	0	0	47	0
Enter Blocked Intersection	No	No	No	No	No	No	No	No	No	No	No	No
Lane Alignment	Left	Left	Right	Left	Left	Right	Left	Left	Right	Left	Left	Right
Median Width(ft)		0			0			0			0	
Link Offset(ft)		0			0			0			0	
Crosswalk Width(ft)		16			16			16			16	
Two way Left Turn Lane												
Headway Factor	1.00	1.00	1.00	1.00	1.00	1.00	1.00	1.00	1.00	1.00	1.00	1.00
Turning Speed (mph)	15		9	15		9	15		9	15		9
Sign Control		Free			Free			Stop			Stop	

Intersection Summary

Area Type:	Other
Control Type:	Unsignalized
Intersection Capacity Utilization	28.5%
ICU Level of Service	A
Analysis Period (min)	15

Intersection												
Int Delay, s/veh	1.5											
Movement	EBL	EBT	EBR	WBL	WBT	WBR	NBL	NBT	NBR	SBL	SBT	SBR
Lane Configurations		↕			↕			↕			↕	
Traffic Vol, veh/h	3	217	2	15	175	4	4	0	6	14	0	28
Future Vol, veh/h	3	217	2	15	175	4	4	0	6	14	0	28
Conflicting Peds, #/hr	0	0	0	0	0	0	0	0	0	0	0	0
Sign Control	Free	Free	Free	Free	Free	Free	Stop	Stop	Stop	Stop	Stop	Stop
RT Channelized	-	-	None	-	-	None	-	-	None	-	-	None
Storage Length	-	-	-	-	-	-	-	-	-	-	-	-
Veh in Median Storage, #	-	0	-	-	0	-	-	0	-	-	0	-
Grade, %	-	0	-	-	0	-	-	0	-	-	0	-
Peak Hour Factor	90	90	90	90	90	90	90	90	90	90	90	90
Heavy Vehicles, %	2	2	2	2	2	2	2	2	2	2	2	2
Mvmt Flow	3	241	2	17	194	4	4	0	7	16	0	31

















Major/Minor	Major1			Major2			Minor1			Minor2		
Conflicting Flow All	198	0	0	243	0	0	494	480	242	482	479	196
Stage 1	-	-	-	-	-	-	248	248	-	230	230	-
Stage 2	-	-	-	-	-	-	246	232	-	252	249	-
Critical Hdwy	4.12	-	-	4.12	-	-	7.12	6.52	6.22	7.12	6.52	6.22
Critical Hdwy Stg 1	-	-	-	-	-	-	6.12	5.52	-	6.12	5.52	-
Critical Hdwy Stg 2	-	-	-	-	-	-	6.12	5.52	-	6.12	5.52	-
Follow-up Hdwy	2.218	-	-	2.218	-	-	3.518	4.018	3.318	3.518	4.018	3.318
Pot Cap-1 Maneuver	1375	-	-	1323	-	-	486	485	797	495	486	845
Stage 1	-	-	-	-	-	-	756	701	-	773	714	-
Stage 2	-	-	-	-	-	-	758	713	-	752	701	-
Platoon blocked, %		-	-		-	-						
Mov Cap-1 Maneuver	1375	-	-	1323	-	-	462	477	797	485	478	845
Mov Cap-2 Maneuver	-	-	-	-	-	-	462	477	-	485	478	-
Stage 1	-	-	-	-	-	-	754	699	-	771	704	-
Stage 2	-	-	-	-	-	-	720	703	-	743	699	-

Approach	EB			WB			NB			SB		
HCM Ctrl Dly, s/v	0.1			0.6			10.9			10.7		
HCM LOS							B			B		

Minor Lane/Major Mvmt	NBLn1	EBL	EBT	EBR	WBL	WBT	WBR	SBLn1
Capacity (veh/h)	618	1375	-	-	1323	-	-	677
HCM Lane V/C Ratio	0.018	0.002	-	-	0.013	-	-	0.069
HCM Ctrl Dly (s/v)	10.9	7.6	0	-	7.8	0	-	10.7
HCM Lane LOS	B	A	A	-	A	A	-	B
HCM 95th %tile Q (veh)	0.1	0	-	-	0	-	-	0.2

Lanes, Volumes, Timings
6: Main Street & Curtis Street

Existing (2025) PM
Burdette North TIS

												
Lane Group	EBL	EBT	EBR	WBL	WBT	WBR	NBL	NBT	NBR	SBL	SBT	SBR
Lane Configurations												
Traffic Volume (vph)	4	255	2	31	244	10	9	0	23	11	0	29
Future Volume (vph)	4	255	2	31	244	10	9	0	23	11	0	29
Ideal Flow (vphpl)	1900	1900	1900	1900	1900	1900	1900	1900	1900	1900	1900	1900
Lane Util. Factor	1.00	1.00	1.00	1.00	1.00	1.00	1.00	1.00	1.00	1.00	1.00	1.00
Frt		0.999			0.995			0.902			0.902	
Flt Protected		0.999			0.995			0.986			0.987	
Satd. Flow (prot)	0	1859	0	0	1844	0	0	1657	0	0	1658	0
Flt Permitted		0.999			0.995			0.986			0.987	
Satd. Flow (perm)	0	1859	0	0	1844	0	0	1657	0	0	1658	0
Link Speed (mph)		25			25			25			25	
Link Distance (ft)		1197			85			1027			565	
Travel Time (s)		32.6			2.3			28.0			15.4	
Peak Hour Factor	0.90	0.90	0.90	0.90	0.90	0.90	0.90	0.90	0.90	0.90	0.90	0.90
Adj. Flow (vph)	4	283	2	34	271	11	10	0	26	12	0	32
Shared Lane Traffic (%)												
Lane Group Flow (vph)	0	289	0	0	316	0	0	36	0	0	44	0
Enter Blocked Intersection	No	No	No	No	No	No	No	No	No	No	No	No
Lane Alignment	Left	Left	Right	Left	Left	Right	Left	Left	Right	Left	Left	Right
Median Width(ft)		0			0			0			0	
Link Offset(ft)		0			0			0			0	
Crosswalk Width(ft)		16			16			16			16	
Two way Left Turn Lane												
Headway Factor	1.00	1.00	1.00	1.00	1.00	1.00	1.00	1.00	1.00	1.00	1.00	1.00
Turning Speed (mph)	15		9	15		9	15		9	15		9
Sign Control		Free			Free			Stop			Stop	

Intersection Summary	
Area Type:	Other
Control Type:	Unsignalized
Intersection Capacity Utilization	41.9%
Analysis Period (min)	15
	ICU Level of Service A

Intersection												
Int Delay, s/veh	1.8											
Movement	EBL	EBT	EBR	WBL	WBT	WBR	NBL	NBT	NBR	SBL	SBT	SBR
Lane Configurations		↕			↕			↕			↕	
Traffic Vol, veh/h	4	255	2	31	244	10	9	0	23	11	0	29
Future Vol, veh/h	4	255	2	31	244	10	9	0	23	11	0	29
Conflicting Peds, #/hr	0	0	0	0	0	0	0	0	0	0	0	0
Sign Control	Free	Free	Free	Free	Free	Free	Stop	Stop	Stop	Stop	Stop	Stop
RT Channelized	-	-	None	-	-	None	-	-	None	-	-	None
Storage Length	-	-	-	-	-	-	-	-	-	-	-	-
Veh in Median Storage, #	-	0	-	-	0	-	-	0	-	-	0	-
Grade, %	-	0	-	-	0	-	-	0	-	-	0	-
Peak Hour Factor	90	90	90	90	90	90	90	90	90	90	90	90
Heavy Vehicles, %	2	2	2	2	2	2	2	2	2	2	2	2
Mvmt Flow	4	283	2	34	271	11	10	0	26	12	0	32

Major/Minor	Major1		Major2		Minor1		Minor2					
Conflicting Flow All	282	0	0	285	0	0	653	642	284	650	638	277
Stage 1	-	-	-	-	-	-	292	292	-	345	345	-
Stage 2	-	-	-	-	-	-	361	350	-	305	293	-
Critical Hdwy	4.12	-	-	4.12	-	-	7.12	6.52	6.22	7.12	6.52	6.22
Critical Hdwy Stg 1	-	-	-	-	-	-	6.12	5.52	-	6.12	5.52	-
Critical Hdwy Stg 2	-	-	-	-	-	-	6.12	5.52	-	6.12	5.52	-
Follow-up Hdwy	2.218	-	-	2.218	-	-	3.518	4.018	3.318	3.518	4.018	3.318
Pot Cap-1 Maneuver	1280	-	-	1277	-	-	380	392	755	382	394	762
Stage 1	-	-	-	-	-	-	716	671	-	671	636	-
Stage 2	-	-	-	-	-	-	657	633	-	705	670	-
Platoon blocked, %		-	-		-	-						
Mov Cap-1 Maneuver	1280	-	-	1277	-	-	354	378	755	359	380	762
Mov Cap-2 Maneuver	-	-	-	-	-	-	354	378	-	359	380	-
Stage 1	-	-	-	-	-	-	713	668	-	668	616	-
Stage 2	-	-	-	-	-	-	609	613	-	678	667	-

Approach	EB		WB		NB		SB	
HCM Ctrl Dly, s/v	0.1		0.9		11.7		11.7	
HCM LOS					B		B	

Minor Lane/Major Mvmt	NBLn1	EBL	EBT	EBR	WBL	WBT	WBR	SBLn1
Capacity (veh/h)	573	1280	-	-	1277	-	-	582
HCM Lane V/C Ratio	0.062	0.003	-	-	0.027	-	-	0.076
HCM Ctrl Dly (s/v)	11.7	7.8	0	-	7.9	0	-	11.7
HCM Lane LOS	B	A	A	-	A	A	-	B
HCM 95th %tile Q (veh)	0.2	0	-	-	0.1	-	-	0.2

Lanes, Volumes, Timings
1: NE Main Street (SC 417) & College Street

No-Build (2028) AM
Burdette North TIS



Lane Group	EBL	EBT	EBR	WBL	WBT	WBR	NBL	NBT	NBR	SBL	SBT	SBR
Lane Configurations					↔↔		↗	↖			↘	↙
Traffic Volume (vph)	0	0	0	122	462	337	30	495	0	0	611	42
Future Volume (vph)	0	0	0	122	462	337	30	495	0	0	611	42
Ideal Flow (vphpl)	1900	1900	1900	1900	1900	1900	1900	1900	1900	1900	1900	1900
Storage Length (ft)	0		0	0		0	150		0	125		0
Storage Lanes	0		0	0		0	1		0	0		0
Taper Length (ft)	100			100			100			100		
Lane Util. Factor	1.00	1.00	1.00	0.95	0.95	0.95	1.00	1.00	1.00	1.00	1.00	1.00
Frt					0.945							0.991
Flt Protected					0.993		0.950					
Satd. Flow (prot)	0	0	0	0	3321	0	1770	1863	0	0	1846	0
Flt Permitted					0.993		0.188					
Satd. Flow (perm)	0	0	0	0	3321	0	350	1863	0	0	1846	0
Right Turn on Red			Yes			Yes			Yes			Yes
Satd. Flow (RTOR)					123							5
Link Speed (mph)		25			25			35				35
Link Distance (ft)		82			413			570				1253
Travel Time (s)		2.2			11.3			11.1				24.4
Peak Hour Factor	0.90	0.90	0.90	0.90	0.90	0.90	0.90	0.90	0.90	0.90	0.90	0.90
Adj. Flow (vph)	0	0	0	136	513	374	33	550	0	0	679	47
Shared Lane Traffic (%)												
Lane Group Flow (vph)	0	0	0	0	1023	0	33	550	0	0	726	0
Enter Blocked Intersection	No	No	No	No	No	No	No	No	No	No	No	No
Lane Alignment	Left	Left	Right	Left	Left	Right	Left	Left	Right	Left	Left	Right
Median Width(ft)		0			0			12				12
Link Offset(ft)		0			0			0				0
Crosswalk Width(ft)		16			16			16				16
Two way Left Turn Lane												
Headway Factor	1.00	1.00	1.00	1.00	1.00	1.00	1.00	1.00	1.00	1.00	1.00	1.00
Turning Speed (mph)	15		9	15		9	15		9	15		9
Number of Detectors				1	2		1	2				2
Detector Template				Left	Thru		Left	Thru				Thru
Leading Detector (ft)				20	100		20	100				100
Trailing Detector (ft)				0	0		0	0				0
Detector 1 Position(ft)				0	0		0	0				0
Detector 1 Size(ft)				20	6		20	6				6
Detector 1 Type				Cl+Ex	Cl+Ex		Cl+Ex	Cl+Ex				Cl+Ex
Detector 1 Channel												
Detector 1 Extend (s)				0.0	0.0		0.0	0.0				0.0
Detector 1 Queue (s)				0.0	0.0		0.0	0.0				0.0
Detector 1 Delay (s)				0.0	0.0		0.0	0.0				0.0
Detector 2 Position(ft)					94			94				94
Detector 2 Size(ft)					6			6				6
Detector 2 Type					Cl+Ex			Cl+Ex				Cl+Ex
Detector 2 Channel												
Detector 2 Extend (s)					0.0			0.0				0.0
Turn Type				Perm	NA		pm+pt	NA				NA
Protected Phases					8		5	2				6
Permitted Phases				8			2					

Lanes, Volumes, Timings
 1: NE Main Street (SC 417) & College Street

No-Build (2028) AM
 Burdette North TIS

Lane Group	EBL	EBT	EBR	WBL	WBT	WBR	NBL	NBT	NBR	SBL	SBT	SBR
Detector Phase				8	8		5	2				6
Switch Phase												
Minimum Initial (s)				7.0	7.0		5.0	12.0				12.0
Minimum Split (s)				22.5	22.5		9.5	22.5				22.5
Total Split (s)				38.0	38.0		9.6	62.0				52.4
Total Split (%)				38.0%	38.0%		9.6%	62.0%				52.4%
Maximum Green (s)				33.5	33.5		5.1	57.5				47.9
Yellow Time (s)				3.5	3.5		3.5	3.5				3.5
All-Red Time (s)				1.0	1.0		1.0	1.0				1.0
Lost Time Adjust (s)					0.0		0.0	0.0				0.0
Total Lost Time (s)					4.5		4.5	4.5				4.5
Lead/Lag							Lag					Lead
Lead-Lag Optimize?							Yes					Yes
Vehicle Extension (s)				3.0	3.0		3.0	3.0				3.0
Recall Mode				None	None		None	C-Max				C-Max
Walk Time (s)				7.0	7.0			7.0				7.0
Flash Don't Walk (s)				11.0	11.0			11.0				11.0
Pedestrian Calls (#/hr)				0	0			0				0
Act Effct Green (s)					32.5		58.5	58.5				52.8
Actuated g/C Ratio					0.33		0.59	0.59				0.53
v/c Ratio					0.88		0.12	0.50				0.74
Control Delay (s/veh)					38.0		3.0	4.0				25.8
Queue Delay					0.0		0.0	0.1				0.0
Total Delay (s/veh)					38.0		3.0	4.1				25.8
LOS					D		A	A				C
Approach Delay (s/veh)					38.0			4.0				25.8
Approach LOS					D			A				C

Intersection Summary

















Area Type: Other
 Cycle Length: 100
 Actuated Cycle Length: 100
 Offset: 14 (14%), Referenced to phase 2:NBTL and 6:SBT, Start of Green
 Natural Cycle: 80
 Control Type: Actuated-Coordinated
 Maximum v/c Ratio: 0.88
 Intersection Signal Delay (s/veh): 25.7 Intersection LOS: C
 Intersection Capacity Utilization 77.2% ICU Level of Service D
 Analysis Period (min) 15

Splits and Phases: 1: NE Main Street (SC 417) & College Street



Lanes, Volumes, Timings
2: NE Main Street (SC 417) & Curtis Street

No-Build (2028) AM
Burdette North TIS

												
Lane Group	EBL	EBT	EBR	WBL	WBT	WBR	NBL	NBT	NBR	SBL	SBT	SBR
Lane Configurations												
Traffic Volume (vph)	65	333	27	0	0	0	0	441	63	190	533	0
Future Volume (vph)	65	333	27	0	0	0	0	441	63	190	533	0
Ideal Flow (vphpl)	1900	1900	1900	1900	1900	1900	1900	1900	1900	1900	1900	1900
Storage Length (ft)	0		0	0		0	150		0	225		0
Storage Lanes	0		0	0		0	0		0	1		0
Taper Length (ft)	100			100			100			100		
Lane Util. Factor	0.95	0.95	0.95	1.00	1.00	1.00	1.00	1.00	1.00	1.00	1.00	1.00
Frt		0.990						0.983				
Flt Protected		0.992								0.950		
Satd. Flow (prot)	0	3476	0	0	0	0	0	1831	0	1770	1863	0
Flt Permitted		0.992								0.329		
Satd. Flow (perm)	0	3476	0	0	0	0	0	1831	0	613	1863	0
Right Turn on Red			Yes			Yes			Yes			Yes
Satd. Flow (RTOR)		6						10				
Link Speed (mph)		25			25			35				35
Link Distance (ft)		85			379			1084				570
Travel Time (s)		2.3			10.3			21.1				11.1
Peak Hour Factor	0.90	0.90	0.90	0.90	0.90	0.90	0.90	0.90	0.90	0.90	0.90	0.90
Adj. Flow (vph)	72	370	30	0	0	0	0	490	70	211	592	0
Shared Lane Traffic (%)												
Lane Group Flow (vph)	0	472	0	0	0	0	0	560	0	211	592	0
Enter Blocked Intersection	No	No	No	No	No	No	No	No	No	No	No	No
Lane Alignment	Left	Left	Right	Left	Left	Right	Left	Left	Right	Left	Left	Right
Median Width(ft)		0			0			12				12
Link Offset(ft)		0			0			0				0
Crosswalk Width(ft)		16			16			16				16
Two way Left Turn Lane												
Headway Factor	1.00	1.00	1.00	1.00	1.00	1.00	1.00	1.00	1.00	1.00	1.00	1.00
Turning Speed (mph)	15		9	15		9	15		9	15		9
Number of Detectors	1	2						2		1	2	
Detector Template	Left	Thru						Thru		Left	Thru	
Leading Detector (ft)	20	100						100		20	100	
Trailing Detector (ft)	0	0						0		0	0	
Detector 1 Position(ft)	0	0						0		0	0	
Detector 1 Size(ft)	20	6						6		20	6	
Detector 1 Type	Cl+Ex	Cl+Ex						Cl+Ex		Cl+Ex	Cl+Ex	
Detector 1 Channel												
Detector 1 Extend (s)	0.0	0.0						0.0		0.0	0.0	
Detector 1 Queue (s)	0.0	0.0						0.0		0.0	0.0	
Detector 1 Delay (s)	0.0	0.0						0.0		0.0	0.0	
Detector 2 Position(ft)		94						94			94	
Detector 2 Size(ft)		6						6			6	
Detector 2 Type		Cl+Ex						Cl+Ex			Cl+Ex	
Detector 2 Channel												
Detector 2 Extend (s)		0.0						0.0			0.0	
Turn Type	Perm	NA						NA		pm+pt	NA	
Protected Phases		4						2		1	6	
Permitted Phases		4								6		

Lanes, Volumes, Timings
2: NE Main Street (SC 417) & Curtis Street

No-Build (2028) AM
Burdette North TIS

	↖		→		↗		↖		↗		↘	
Lane Group	EBL	EBT	EBR	WBL	WBT	WBR	NBL	NBT	NBR	SBL	SBT	SBR
Detector Phase	4	4						2		1	6	
Switch Phase												
Minimum Initial (s)	7.0	7.0						12.0		5.0	12.0	
Minimum Split (s)	22.5	22.5						22.5		9.5	22.5	
Total Split (s)	27.0	27.0						55.0		18.0	73.0	
Total Split (%)	27.0%	27.0%						55.0%		18.0%	73.0%	
Maximum Green (s)	22.5	22.5						50.5		13.5	68.5	
Yellow Time (s)	3.5	3.5						3.5		3.5	3.5	
All-Red Time (s)	1.0	1.0						1.0		1.0	1.0	
Lost Time Adjust (s)		0.0						0.0		0.0	0.0	
Total Lost Time (s)		4.5						4.5		4.5	4.5	
Lead/Lag								Lead		Lag		
Lead-Lag Optimize?								Yes		Yes		
Vehicle Extension (s)	3.0	3.0						3.0		3.0	3.0	
Recall Mode	None	None						C-Max		None	C-Max	
Walk Time (s)	7.0	7.0						7.0			7.0	
Flash Don't Walk (s)	11.0	11.0						11.0			11.0	
Pedestrian Calls (#/hr)	0	0						0			0	
Act Effct Green (s)		18.8						54.2		72.2	72.2	
Actuated g/C Ratio		0.19						0.54		0.72	0.72	
v/c Ratio		0.72						0.56		0.35	0.44	
Control Delay (s/veh)		43.9						18.2		2.6	2.2	
Queue Delay		0.0						0.0		0.0	0.3	
Total Delay (s/veh)		43.9						18.2		2.6	2.5	
LOS		D						B		A	A	
Approach Delay (s/veh)		43.9						18.2			2.5	
Approach LOS		D						B			A	

Intersection Summary

Area Type: Other
 Cycle Length: 100
 Actuated Cycle Length: 100
 Offset: 9 (9%), Referenced to phase 2:NBT and 6:SBTL, Start of Green
 Natural Cycle: 60
 Control Type: Actuated-Coordinated
 Maximum v/c Ratio: 0.72
 Intersection Signal Delay (s/veh): 18.0 Intersection LOS: B
 Intersection Capacity Utilization 77.2% ICU Level of Service D
 Analysis Period (min) 15

Splits and Phases: 2: NE Main Street (SC 417) & Curtis Street

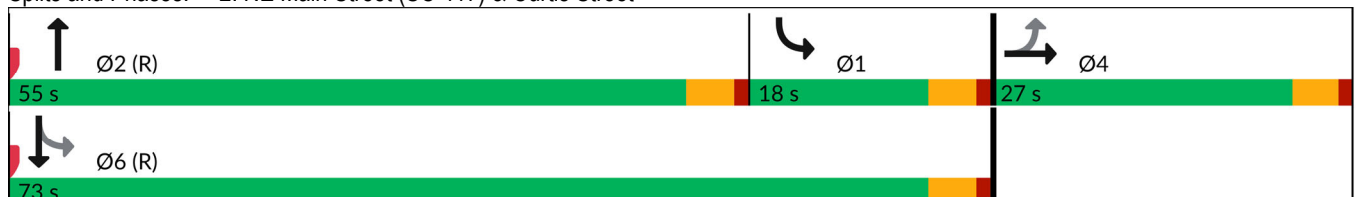

Lanes, Volumes, Timings
 3: Hedge Street & College Street

No-Build (2028) AM
 Burdette North TIS

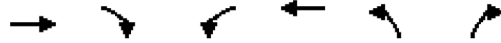

Lane Group	EBT	EBR	WBL	WBT	NBL	NBR
Lane Configurations				↔↔	↔	
Traffic Volume (vph)	0	0	213	890	24	0
Future Volume (vph)	0	0	213	890	24	0
Ideal Flow (vphp)	1900	1900	1900	1900	1900	1900
Lane Util. Factor	1.00	1.00	0.95	0.95	1.00	1.00
Frnt						
Flt Protected				0.990	0.950	
Satd. Flow (prot)	0	0	0	3504	1770	0
Flt Permitted				0.990	0.950	
Satd. Flow (perm)	0	0	0	3504	1770	0
Link Speed (mph)	25			25	25	
Link Distance (ft)	413			1158	568	
Travel Time (s)	11.3			31.6	15.5	
Peak Hour Factor	0.90	0.90	0.90	0.90	0.90	0.90
Adj. Flow (vph)	0	0	237	989	27	0
Shared Lane Traffic (%)						
Lane Group Flow (vph)	0	0	0	1226	27	0
Enter Blocked Intersection	No	No	No	No	No	No
Lane Alignment	Left	Right	Left	Left	Left	Right
Median Width(ft)	0			0	12	
Link Offset(ft)	0			0	0	
Crosswalk Width(ft)	16			16	16	
Two way Left Turn Lane						
Headway Factor	1.00	1.00	1.00	1.00	1.00	1.00
Turning Speed (mph)		9	15		15	9
Sign Control	Free			Free	Stop	

Intersection Summary	
Area Type:	Other
Control Type:	Unsignalized
Intersection Capacity Utilization	40.8% ICU Level of Service A
Analysis Period (min)	15

Intersection						
Int Delay, s/veh	0.4					
Movement	EBT	EBR	WBL	WBT	NBL	NBR
Lane Configurations				↑↑	↑	
Traffic Vol, veh/h	0	0	213	890	24	0
Future Vol, veh/h	0	0	213	890	24	0
Conflicting Peds, #/hr	0	0	0	0	0	0
Sign Control	Free	Free	Free	Free	Stop	Stop
RT Channelized	-	None	-	None	-	None
Storage Length	-	-	-	-	0	-
Veh in Median Storage, #	0	-	-	0	0	-
Grade, %	0	-	-	0	0	-
Peak Hour Factor	90	90	90	90	90	90
Heavy Vehicles, %	2	2	2	2	2	2
Mvmt Flow	0	0	237	989	27	0















Major/Minor	Major2	Minor1		
Conflicting Flow All	0	0	969	-
Stage 1	-	-	0	-
Stage 2	-	-	969	-
Critical Hdwy	4.14	-	6.84	-
Critical Hdwy Stg 1	-	-	-	-
Critical Hdwy Stg 2	-	-	5.84	-
Follow-up Hdwy	2.22	-	3.52	-
Pot Cap-1 Maneuver	-	-	251	0
Stage 1	-	-	-	0
Stage 2	-	-	329	0
Platoon blocked, %			-	
Mov Cap-1 Maneuver	-	-	251	-
Mov Cap-2 Maneuver	-	-	251	-
Stage 1	-	-	-	-
Stage 2	-	-	329	-

Approach	WB	NB
HCM Ctrl Dly, s/v		21
HCM LOS		C

Minor Lane/Major Mvmt	NBLn1	WBL	WBT
Capacity (veh/h)	251	-	-
HCM Lane V/C Ratio	0.106	-	-
HCM Ctrl Dly (s/v)	21	-	-
HCM Lane LOS	C	-	-
HCM 95th %tile Q (veh)	0.4	-	-

Lanes, Volumes, Timings
4: Hedge Street & Curtis Street

No-Build (2028) AM
Burdette North TIS

												
Lane Group	EBL	EBT	EBR	WBL	WBT	WBR	NBL	NBT	NBR	SBL	SBT	SBR
Lane Configurations												
Traffic Volume (vph)	4	501	54	0	0	0	0	28	194	37	180	0
Future Volume (vph)	4	501	54	0	0	0	0	28	194	37	180	0
Ideal Flow (vphpl)	1900	1900	1900	1900	1900	1900	1900	1900	1900	1900	1900	1900
Lane Util. Factor	0.95	0.95	0.95	1.00	1.00	1.00	1.00	1.00	1.00	1.00	1.00	1.00
Fr _t		0.986						0.882				
Fl _t Protected											0.992	
Satd. Flow (prot)	0	3490	0	0	0	0	0	1643	0	0	1848	0
Fl _t Permitted											0.992	
Satd. Flow (perm)	0	3490	0	0	0	0	0	1643	0	0	1848	0
Right Turn on Red			Yes			Yes			Yes			Yes
Satd. Flow (RTOR)		12						216				
Link Speed (mph)		25			25			25			25	
Link Distance (ft)		379			1213			1024			568	
Travel Time (s)		10.3			33.1			27.9			15.5	
Peak Hour Factor	0.90	0.90	0.90	0.90	0.90	0.90	0.90	0.90	0.90	0.90	0.90	0.90
Adj. Flow (vph)	4	557	60	0	0	0	0	31	216	41	200	0
Shared Lane Traffic (%)												
Lane Group Flow (vph)	0	621	0	0	0	0	0	247	0	0	241	0
Enter Blocked Intersection	No	No	No	No	No	No	No	No	No	No	No	No
Lane Alignment	Left	Left	Right	Left	Left	Right	Left	Left	Right	Left	Left	Right
Median Width(ft)		0			0			0			0	
Link Offset(ft)		0			0			0			0	
Crosswalk Width(ft)		16			16			16			16	
Two way Left Turn Lane												
Headway Factor	1.00	1.00	1.00	1.00	1.00	1.00	1.00	1.00	1.00	1.00	1.00	1.00
Turning Speed (mph)	15		9	15		9	15		9	15		9
Number of Detectors	1	2						1		1	1	
Detector Template	Left	Thru								Left		
Leading Detector (ft)	20	100						30		20	30	
Trailing Detector (ft)	0	0						0		0	0	
Detector 1 Position(ft)	0	0						0		0	0	
Detector 1 Size(ft)	20	6						30		20	30	
Detector 1 Type	Cl+Ex	Cl+Ex						Cl+Ex		Cl+Ex	Cl+Ex	
Detector 1 Channel												
Detector 1 Extend (s)	0.0	0.0						0.0		0.0	0.0	
Detector 1 Queue (s)	0.0	0.0						0.0		0.0	0.0	
Detector 1 Delay (s)	0.0	0.0						0.0		0.0	0.0	
Detector 2 Position(ft)		94										
Detector 2 Size(ft)		6										
Detector 2 Type		Cl+Ex										
Detector 2 Channel												
Detector 2 Extend (s)		0.0										
Turn Type	Perm	NA						NA		Split	NA	
Protected Phases		2						4		8	8	
Permitted Phases	2											
Detector Phase	2	2						4		8	8	
Switch Phase												
Minimum Initial (s)	7.0	7.0						7.0		7.0	7.0	

Lanes, Volumes, Timings
4: Hedge Street & Curtis Street

No-Build (2028) AM
Burdette North TIS

Lane Group	EBL	EBT	EBR	WBL	WBT	WBR	NBL	NBT	NBR	SBL	SBT	SBR
Minimum Split (s)	22.5	22.5						22.5		22.5	22.5	
Total Split (s)	38.0	38.0						29.0		33.0	33.0	
Total Split (%)	38.0%	38.0%						29.0%		33.0%	33.0%	
Maximum Green (s)	33.5	33.5						24.5		28.5	28.5	
Yellow Time (s)	3.5	3.5						3.5		3.5	3.5	
All-Red Time (s)	1.0	1.0						1.0		1.0	1.0	
Lost Time Adjust (s)		0.0						0.0			0.0	
Total Lost Time (s)		4.5						4.5			4.5	
Lead/Lag												
Lead-Lag Optimize?												
Vehicle Extension (s)	3.0	3.0						3.0		3.0	3.0	
Recall Mode	C-Max	C-Max						None		None	None	
Walk Time (s)	7.0	7.0						7.0		7.0	7.0	
Flash Don't Walk (s)	11.0	11.0						11.0		11.0	11.0	
Pedestrian Calls (#/hr)	0	0						0		0	0	
Act Effct Green (s)		58.5						9.7			18.3	
Actuated g/C Ratio		0.59						0.10			0.18	
v/c Ratio		0.30						0.70			0.71	
Control Delay (s/veh)		6.7						19.6			49.8	
Queue Delay		0.2						0.0			0.0	
Total Delay (s/veh)		6.9						19.6			49.8	
LOS		A						B			D	
Approach Delay (s/veh)		6.9						19.6			49.8	
Approach LOS		A						B			D	

Intersection Summary





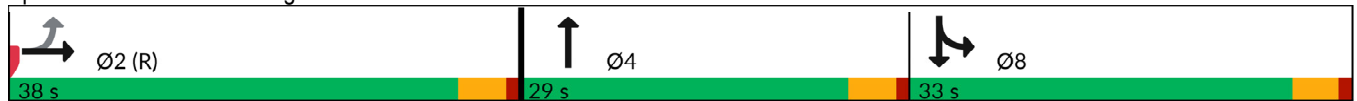









Area Type:	Other
Cycle Length:	100
Actuated Cycle Length:	100
Offset:	76 (76%), Referenced to phase 2:EBTL, Start of Green
Natural Cycle:	70
Control Type:	Actuated-Coordinated
Maximum v/c Ratio:	0.71
Intersection Signal Delay (s/veh):	19.0
Intersection LOS:	B
Intersection Capacity Utilization:	51.9%
ICU Level of Service:	A
Analysis Period (min):	15

Splits and Phases: 4: Hedge Street & Curtis Street



Lanes, Volumes, Timings
5: Main Street & College Street

No-Build (2028) AM
Burdette North TIS

												
Lane Group	EBL	EBT	EBR	WBL	WBT	WBR	NBL	NBT	NBR	SBL	SBT	SBR
Lane Configurations												
Traffic Volume (vph)	0	0	0	27	498	10	32	5	0	0	1	22
Future Volume (vph)	0	0	0	27	498	10	32	5	0	0	1	22
Ideal Flow (vphpl)	1900	1900	1900	1900	1900	1900	1900	1900	1900	1900	1900	1900
Lane Util. Factor	1.00	1.00	1.00	0.95	0.95	0.95	1.00	1.00	1.00	1.00	1.00	1.00
Frt					0.997						0.870	
Flt Protected					0.997			0.959				
Satd. Flow (prot)	0	0	0	0	3518	0	0	1786	0	0	1621	0
Flt Permitted					0.997			0.959				
Satd. Flow (perm)	0	0	0	0	3518	0	0	1786	0	0	1621	0
Link Speed (mph)		25			25			25			25	
Link Distance (ft)		1082			82			565			1260	
Travel Time (s)		29.5			2.2			15.4			34.4	
Peak Hour Factor	0.90	0.90	0.90	0.90	0.90	0.90	0.90	0.90	0.90	0.90	0.90	0.90
Adj. Flow (vph)	0	0	0	30	553	11	36	6	0	0	1	24
Shared Lane Traffic (%)												
Lane Group Flow (vph)	0	0	0	0	594	0	0	42	0	0	25	0
Enter Blocked Intersection	No	No	No	No	No	No	No	No	No	No	No	No
Lane Alignment	Left	Left	Right	Left	Left	Right	Left	Left	Right	Left	Left	Right
Median Width(ft)		0			0			0			0	
Link Offset(ft)		0			0			0			0	
Crosswalk Width(ft)		16			16			16			16	
Two way Left Turn Lane												
Headway Factor	1.00	1.00	1.00	1.00	1.00	1.00	1.00	1.00	1.00	1.00	1.00	1.00
Turning Speed (mph)	15		9	15		9	15		9	15		9
Sign Control		Free			Free			Stop			Stop	
Intersection Summary												
Area Type:	Other											
Control Type:	Unsignalized											
Intersection Capacity Utilization	30.2%			ICU Level of Service A								
Analysis Period (min)	15											

Intersection												
Int Delay, s/veh	1.2											
Movement	EBL	EBT	EBR	WBL	WBT	WBR	NBL	NBT	NBR	SBL	SBT	SBR
Lane Configurations					↔↔			↔			↔	
Traffic Vol, veh/h	0	0	0	27	498	10	32	5	0	0	1	22
Future Vol, veh/h	0	0	0	27	498	10	32	5	0	0	1	22
Conflicting Peds, #/hr	0	0	0	0	0	0	0	0	0	0	0	0
Sign Control	Free	Free	Free	Free	Free	Free	Stop	Stop	Stop	Stop	Stop	Stop
RT Channelized	-	-	None	-	-	None	-	-	None	-	-	None
Storage Length	-	-	-	-	-	-	-	-	-	-	-	-
Veh in Median Storage, #	-	0	-	-	0	-	-	0	-	-	0	-
Grade, %	-	0	-	-	0	-	-	0	-	-	0	-
Peak Hour Factor	90	90	90	90	90	90	90	90	90	90	90	90
Heavy Vehicles, %	2	2	2	2	2	2	2	2	2	2	2	2
Mvmt Flow	0	0	0	30	553	11	36	6	0	0	1	24















Major/Minor	Major2	Minor1	Minor2
Conflicting Flow All	0	0	0
Stage 1	-	-	-
Stage 2	-	-	-
Critical Hdwy	4.14	-	-
Critical Hdwy Stg 1	-	-	-
Critical Hdwy Stg 2	-	-	-
Follow-up Hdwy	2.22	-	-
Pot Cap-1 Maneuver	-	-	-
Stage 1	-	-	-
Stage 2	-	-	-
Platoon blocked, %	-	-	-
Mov Cap-1 Maneuver	-	-	-
Mov Cap-2 Maneuver	-	-	-
Stage 1	-	-	-
Stage 2	-	-	-

Approach	WB	NB	SB
HCM Ctrl Dly, s/v		12.2	10.4
HCM LOS		B	B

Minor Lane/Major Mvmt	NBLn1	WBL	WBT	WBR	SBLn1
Capacity (veh/h)	541	-	-	-	692
HCM Lane V/C Ratio	0.076	-	-	-	0.037
HCM Ctrl Dly (s/v)	12.2	-	-	-	10.4
HCM Lane LOS	B	-	-	-	B
HCM 95th %tile Q (veh)	0.2	-	-	-	0.1

Lanes, Volumes, Timings
6: Main Street & Curtis Street

No-Build (2028) AM
Burdette North TIS

												
Lane Group	EBL	EBT	EBR	WBL	WBT	WBR	NBL	NBT	NBR	SBL	SBT	SBR
Lane Configurations												
Traffic Volume (vph)	6	402	13	0	0	0	0	7	20	2	13	0
Future Volume (vph)	6	402	13	0	0	0	0	7	20	2	13	0
Ideal Flow (vphpl)	1900	1900	1900	1900	1900	1900	1900	1900	1900	1900	1900	1900
Lane Util. Factor	0.95	0.95	0.95	1.00	1.00	1.00	1.00	1.00	1.00	1.00	1.00	1.00
Fr _t		0.996						0.901				
Fl _t Protected		0.999									0.994	
Satd. Flow (prot)	0	3522	0	0	0	0	0	1678	0	0	1852	0
Fl _t Permitted		0.999									0.994	
Satd. Flow (perm)	0	3522	0	0	0	0	0	1678	0	0	1852	0
Link Speed (mph)		25			25			25			25	
Link Distance (ft)		1197			85			1027			565	
Travel Time (s)		32.6			2.3			28.0			15.4	
Peak Hour Factor	0.90	0.90	0.90	0.90	0.90	0.90	0.90	0.90	0.90	0.90	0.90	0.90
Adj. Flow (vph)	7	447	14	0	0	0	0	8	22	2	14	0
Shared Lane Traffic (%)												
Lane Group Flow (vph)	0	468	0	0	0	0	0	30	0	0	16	0
Enter Blocked Intersection	No	No	No	No	No	No	No	No	No	No	No	No
Lane Alignment	Left	Left	Right	Left	Left	Right	Left	Left	Right	Left	Left	Right
Median Width(ft)		0			0			0			0	
Link Offset(ft)		0			0			0			0	
Crosswalk Width(ft)		16			16			16			16	
Two way Left Turn Lane												
Headway Factor	1.00	1.00	1.00	1.00	1.00	1.00	1.00	1.00	1.00	1.00	1.00	1.00
Turning Speed (mph)	15		9	15		9	15		9	15		9
Sign Control		Free			Free			Stop			Stop	
Intersection Summary												
Area Type:	Other											
Control Type:	Unsignalized											
Intersection Capacity Utilization	21.7%						ICU Level of Service A					
Analysis Period (min)	15											

Intersection												
Int Delay, s/veh	1											
Movement	EBL	EBT	EBR	WBL	WBT	WBR	NBL	NBT	NBR	SBL	SBT	SBR
Lane Configurations		↔↔						↔			↔	
Traffic Vol, veh/h	6	402	13	0	0	0	0	7	20	2	13	0
Future Vol, veh/h	6	402	13	0	0	0	0	7	20	2	13	0
Conflicting Peds, #/hr	0	0	0	0	0	0	0	0	0	0	0	0
Sign Control	Free	Free	Free	Free	Free	Free	Stop	Stop	Stop	Stop	Stop	Stop
RT Channelized	-	-	None	-	-	None	-	-	None	-	-	None
Storage Length	-	-	-	-	-	-	-	-	-	-	-	-
Veh in Median Storage, #	-	0	-	-	0	-	-	0	-	-	0	-
Grade, %	-	0	-	-	0	-	-	0	-	-	0	-
Peak Hour Factor	90	90	90	90	90	90	90	90	90	90	90	90
Heavy Vehicles, %	2	2	2	2	2	2	2	2	2	2	2	2
Mvmt Flow	7	447	14	0	0	0	0	8	22	2	14	0

Major/Minor	Major1			Minor1			Minor2		
Conflicting Flow All	0	0	0	-	468	231	242	475	-
Stage 1	-	-	-	-	468	-	0	0	-
Stage 2	-	-	-	-	0	-	242	475	-
Critical Hdwy	4.14	-	-	-	6.54	6.94	7.54	6.54	-
Critical Hdwy Stg 1	-	-	-	-	5.54	-	-	-	-
Critical Hdwy Stg 2	-	-	-	-	-	-	6.54	5.54	-
Follow-up Hdwy	2.22	-	-	-	4.02	3.32	3.52	4.02	-
Pot Cap-1 Maneuver	-	-	-	0	491	771	692	487	0
Stage 1	-	-	-	0	560	-	-	-	0
Stage 2	-	-	-	0	-	-	740	556	0
Platoon blocked, %	-	-	-	-	-	-	-	-	-
Mov Cap-1 Maneuver	-	-	-	-	491	771	664	487	-
Mov Cap-2 Maneuver	-	-	-	-	491	-	664	487	-
Stage 1	-	-	-	-	560	-	-	-	-
Stage 2	-	-	-	-	-	-	709	556	-

Approach	EB	NB	SB
HCM Ctrl Dly, s/v		10.6	12.4
HCM LOS		B	B

Minor Lane/Major Mvmt	NBLn1	EBL	EBT	EBR	SBLn1
Capacity (veh/h)	672	-	-	-	505
HCM Lane V/C Ratio	0.045	-	-	-	0.033
HCM Ctrl Dly (s/v)	10.6	-	-	-	12.4
HCM Lane LOS	B	-	-	-	B
HCM 95th %tile Q (veh)	0.1	-	-	-	0.1

Lanes, Volumes, Timings
1: NE Main Street (SC 417) & College Street

No-Build (2028) PM
Burdette North TIS



Lane Group	EBL	EBT	EBR	WBL	WBT	WBR	NBL	NBT	NBR	SBL	SBT	SBR
Lane Configurations					↔↔		↗	↖			↘	↙
Traffic Volume (vph)	0	0	0	76	371	167	59	506	0	0	834	77
Future Volume (vph)	0	0	0	76	371	167	59	506	0	0	834	77
Ideal Flow (vphpl)	1900	1900	1900	1900	1900	1900	1900	1900	1900	1900	1900	1900
Storage Length (ft)	0		0	0		0	150		0	125		0
Storage Lanes	0		0	0		0	1		0	0		0
Taper Length (ft)	100			100			100			100		
Lane Util. Factor	1.00	1.00	1.00	0.95	0.95	0.95	1.00	1.00	1.00	1.00	1.00	1.00
Frt					0.959							0.989
Flt Protected					0.994		0.950					
Satd. Flow (prot)	0	0	0	0	3374	0	1770	1863	0	0	1842	0
Flt Permitted					0.994		0.083					
Satd. Flow (perm)	0	0	0	0	3374	0	155	1863	0	0	1842	0
Right Turn on Red			Yes			Yes			Yes			Yes
Satd. Flow (RTOR)					50							8
Link Speed (mph)		25			25			35				35
Link Distance (ft)		82			413			570				1253
Travel Time (s)		2.2			11.3			11.1				24.4
Peak Hour Factor	0.90	0.90	0.90	0.90	0.90	0.90	0.90	0.90	0.90	0.90	0.90	0.90
Adj. Flow (vph)	0	0	0	84	412	186	66	562	0	0	927	86
Shared Lane Traffic (%)												
Lane Group Flow (vph)	0	0	0	0	682	0	66	562	0	0	1013	0
Enter Blocked Intersection	No	No	No	No	No	No	No	No	No	No	No	No
Lane Alignment	Left	Left	Right	Left	Left	Right	Left	Left	Right	Left	Left	Right
Median Width(ft)		0			0			12				12
Link Offset(ft)		0			0			0				0
Crosswalk Width(ft)		16			16			16				16
Two way Left Turn Lane												
Headway Factor	1.00	1.00	1.00	1.00	1.00	1.00	1.00	1.00	1.00	1.00	1.00	1.00
Turning Speed (mph)	15		9	15		9	15		9	15		9
Number of Detectors				1	2		1	2				2
Detector Template				Left	Thru		Left	Thru				Thru
Leading Detector (ft)				20	100		20	100				100
Trailing Detector (ft)				0	0		0	0				0
Detector 1 Position(ft)				0	0		0	0				0
Detector 1 Size(ft)				20	6		20	6				6
Detector 1 Type				Cl+Ex	Cl+Ex		Cl+Ex	Cl+Ex				Cl+Ex
Detector 1 Channel												
Detector 1 Extend (s)				0.0	0.0		0.0	0.0				0.0
Detector 1 Queue (s)				0.0	0.0		0.0	0.0				0.0
Detector 1 Delay (s)				0.0	0.0		0.0	0.0				0.0
Detector 2 Position(ft)					94			94				94
Detector 2 Size(ft)					6			6				6
Detector 2 Type					Cl+Ex			Cl+Ex				Cl+Ex
Detector 2 Channel												
Detector 2 Extend (s)					0.0			0.0				0.0
Turn Type				Perm	NA		pm+pt	NA				NA
Protected Phases					8		5	2				6
Permitted Phases				8			2					

Lanes, Volumes, Timings
 1: NE Main Street (SC 417) & College Street

No-Build (2028) PM
 Burdette North TIS

Lane Group	EBL	EBT	EBR	WBL	WBT	WBR	NBL	NBT	NBR	SBL	SBT	SBR
Detector Phase				8	8		5	2			6	
Switch Phase												
Minimum Initial (s)				7.0	7.0		5.0	12.0			12.0	
Minimum Split (s)				22.5	22.5		9.5	22.5			22.5	
Total Split (s)				27.0	27.0		10.0	73.0			63.0	
Total Split (%)				27.0%	27.0%		10.0%	73.0%			63.0%	
Maximum Green (s)				22.5	22.5		5.5	68.5			58.5	
Yellow Time (s)				3.5	3.5		3.5	3.5			3.5	
All-Red Time (s)				1.0	1.0		1.0	1.0			1.0	
Lost Time Adjust (s)					0.0		0.0	0.0			0.0	
Total Lost Time (s)					4.5		4.5	4.5			4.5	
Lead/Lag							Lag				Lead	
Lead-Lag Optimize?							Yes				Yes	
Vehicle Extension (s)				3.0	3.0		3.0	3.0			3.0	
Recall Mode				None	None		None	C-Max			C-Max	
Walk Time (s)				7.0	7.0			7.0			7.0	
Flash Don't Walk (s)				11.0	11.0			11.0			11.0	
Pedestrian Calls (#/hr)				0	0			0			0	
Act Effct Green (s)					21.9		69.1	69.1			61.1	
Actuated g/C Ratio					0.22		0.69	0.69			0.61	
v/c Ratio					0.88		0.34	0.44			0.90	
Control Delay (s/veh)					48.6		7.7	2.0			30.5	
Queue Delay					0.0		0.0	0.5			0.0	
Total Delay (s/veh)					48.6		7.7	2.4			30.5	
LOS					D		A	A			C	
Approach Delay (s/veh)					48.6			3.0			30.5	
Approach LOS					D			A			C	

Intersection Summary

















Area Type: Other
 Cycle Length: 100
 Actuated Cycle Length: 100
 Offset: 38 (38%), Referenced to phase 2:NBTL and 6:SBT, Start of Green
 Natural Cycle: 90
 Control Type: Actuated-Coordinated
 Maximum v/c Ratio: 0.90
 Intersection Signal Delay (s/veh): 28.4 Intersection LOS: C
 Intersection Capacity Utilization 82.8% ICU Level of Service E
 Analysis Period (min) 15

Splits and Phases: 1: NE Main Street (SC 417) & College Street



Lanes, Volumes, Timings
2: NE Main Street (SC 417) & Curtis Street

No-Build (2028) PM
Burdette North TIS

												
Lane Group	EBL	EBT	EBR	WBL	WBT	WBR	NBL	NBT	NBR	SBL	SBT	SBR
Lane Configurations												
Traffic Volume (vph)	52	455	51	0	0	0	0	454	221	333	551	0
Future Volume (vph)	52	455	51	0	0	0	0	454	221	333	551	0
Ideal Flow (vphp)	1900	1900	1900	1900	1900	1900	1900	1900	1900	1900	1900	1900
Storage Length (ft)	0		0	0		0	150		0	225		0
Storage Lanes	0		0	0		0	0		0	1		0
Taper Length (ft)	100			100			100			100		
Lane Util. Factor	0.95	0.95	0.95	1.00	1.00	1.00	1.00	1.00	1.00	1.00	1.00	1.00
Frt		0.986						0.956				
Flt Protected		0.995								0.950		
Satd. Flow (prot)	0	3472	0	0	0	0	0	1781	0	1770	1863	0
Flt Permitted		0.995								0.144		
Satd. Flow (perm)	0	3472	0	0	0	0	0	1781	0	268	1863	0
Right Turn on Red			Yes			Yes			Yes			Yes
Satd. Flow (RTOR)		10						33				
Link Speed (mph)		25			25			35				35
Link Distance (ft)		85			379			1084				570
Travel Time (s)		2.3			10.3			21.1				11.1
Peak Hour Factor	0.90	0.90	0.90	0.90	0.90	0.90	0.90	0.90	0.90	0.90	0.90	0.90
Adj. Flow (vph)	58	506	57	0	0	0	0	504	246	370	612	0
Shared Lane Traffic (%)												
Lane Group Flow (vph)	0	621	0	0	0	0	0	750	0	370	612	0
Enter Blocked Intersection	No	No	No	No	No	No	No	No	No	No	No	No
Lane Alignment	Left	Left	Right	Left	Left	Right	Left	Left	Right	Left	Left	Right
Median Width(ft)		0			0			12				12
Link Offset(ft)		0			0			0				0
Crosswalk Width(ft)		16			16			16				16
Two way Left Turn Lane												
Headway Factor	1.00	1.00	1.00	1.00	1.00	1.00	1.00	1.00	1.00	1.00	1.00	1.00
Turning Speed (mph)	15		9	15		9	15		9	15		9
Number of Detectors	1	2						2		1	2	
Detector Template	Left	Thru						Thru		Left	Thru	
Leading Detector (ft)	20	100						100		20	100	
Trailing Detector (ft)	0	0						0		0	0	
Detector 1 Position(ft)	0	0						0		0	0	
Detector 1 Size(ft)	20	6						6		20	6	
Detector 1 Type	Cl+Ex	Cl+Ex						Cl+Ex		Cl+Ex	Cl+Ex	
Detector 1 Channel												
Detector 1 Extend (s)	0.0	0.0						0.0		0.0	0.0	
Detector 1 Queue (s)	0.0	0.0						0.0		0.0	0.0	
Detector 1 Delay (s)	0.0	0.0						0.0		0.0	0.0	
Detector 2 Position(ft)		94						94			94	
Detector 2 Size(ft)		6						6			6	
Detector 2 Type		Cl+Ex						Cl+Ex			Cl+Ex	
Detector 2 Channel												
Detector 2 Extend (s)		0.0						0.0			0.0	
Turn Type	Perm	NA						NA		pm+pt	NA	
Protected Phases		4						2		1	6	
Permitted Phases		4								6		

Lanes, Volumes, Timings
2: NE Main Street (SC 417) & Curtis Street

No-Build (2028) PM
Burdette North TIS

	↖		→		↘		↙		←		↗		↖		↑		↘		↓		↙		
Lane Group	EBL	EBT	EBR	WBL	WBT	WBR	NBL	NBT	NBR	SBL	SBT	SBR											
Detector Phase	4	4						2		1	6												
Switch Phase																							
Minimum Initial (s)	7.0	7.0						12.0		5.0	12.0												
Minimum Split (s)	22.5	22.5						22.5		9.5	22.5												
Total Split (s)	25.0	25.0						52.0		23.0	75.0												
Total Split (%)	25.0%	25.0%						52.0%		23.0%	75.0%												
Maximum Green (s)	20.5	20.5						47.5		18.5	70.5												
Yellow Time (s)	3.5	3.5						3.5		3.5	3.5												
All-Red Time (s)	1.0	1.0						1.0		1.0	1.0												
Lost Time Adjust (s)		0.0						0.0		0.0	0.0												
Total Lost Time (s)		4.5						4.5		4.5	4.5												
Lead/Lag								Lead		Lag													
Lead-Lag Optimize?								Yes		Yes													
Vehicle Extension (s)	3.0	3.0						3.0		3.0	3.0												
Recall Mode	None	None						C-Max		None	C-Max												
Walk Time (s)	7.0	7.0						7.0			7.0												
Flash Don't Walk (s)	11.0	11.0						11.0			11.0												
Pedestrian Calls (#/hr)	0	0						0			0												
Act Effct Green (s)		20.0						48.0		71.0	71.0												
Actuated g/C Ratio		0.20						0.48		0.71	0.71												
v/c Ratio		0.88						0.86		0.79	0.46												
Control Delay (s/veh)		54.0						34.1		20.2	1.5												
Queue Delay		0.0						0.0		0.7	0.4												
Total Delay (s/veh)		54.0						34.1		21.0	1.9												
LOS		D						C		C	A												
Approach Delay (s/veh)		54.0						34.1			9.1												
Approach LOS		D						C			A												

Intersection Summary

Area Type: Other
 Cycle Length: 100
 Actuated Cycle Length: 100
 Offset: 39 (39%), Referenced to phase 2:NBT and 6:SBTL, Start of Green
 Natural Cycle: 90
 Control Type: Actuated-Coordinated
 Maximum v/c Ratio: 0.88
 Intersection Signal Delay (s/veh): 28.9 Intersection LOS: C
 Intersection Capacity Utilization 82.8% ICU Level of Service E
 Analysis Period (min) 15

Splits and Phases: 2: NE Main Street (SC 417) & Curtis Street



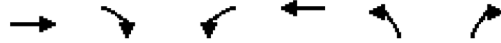

Lane Group	EBT	EBR	WBL	WBT	NBL	NBR
Lane Configurations				↔↔	↔	
Traffic Volume (vph)	0	0	138	576	21	0
Future Volume (vph)	0	0	138	576	21	0
Ideal Flow (vphp)	1900	1900	1900	1900	1900	1900
Lane Util. Factor	1.00	1.00	0.95	0.95	1.00	1.00
Frnt						
Flt Protected				0.990	0.950	
Satd. Flow (prot)	0	0	0	3504	1770	0
Flt Permitted				0.990	0.950	
Satd. Flow (perm)	0	0	0	3504	1770	0
Link Speed (mph)	25			25	25	
Link Distance (ft)	413			1158	568	
Travel Time (s)	11.3			31.6	15.5	
Peak Hour Factor	0.90	0.90	0.90	0.90	0.90	0.90
Adj. Flow (vph)	0	0	153	640	23	0
Shared Lane Traffic (%)						
Lane Group Flow (vph)	0	0	0	793	23	0
Enter Blocked Intersection	No	No	No	No	No	No
Lane Alignment	Left	Right	Left	Left	Left	Right
Median Width(ft)	0			0	12	
Link Offset(ft)	0			0	0	
Crosswalk Width(ft)	16			16	16	
Two way Left Turn Lane						
Headway Factor	1.00	1.00	1.00	1.00	1.00	1.00
Turning Speed (mph)		9	15		15	9
Sign Control	Free			Free	Stop	

Intersection Summary	
Area Type:	Other
Control Type:	Unsignalized
Intersection Capacity Utilization	29.9% ICU Level of Service A
Analysis Period (min)	15

Intersection						
Int Delay, s/veh	0.4					
Movement	EBT	EBR	WBL	WBT	NBL	NBR
Lane Configurations				↑↑	↑	
Traffic Vol, veh/h	0	0	138	576	21	0
Future Vol, veh/h	0	0	138	576	21	0
Conflicting Peds, #/hr	0	0	0	0	0	0
Sign Control	Free	Free	Free	Free	Stop	Stop
RT Channelized	-	None	-	None	-	None
Storage Length	-	-	-	-	0	-
Veh in Median Storage, #	0	-	-	0	0	-
Grade, %	0	-	-	0	0	-
Peak Hour Factor	90	90	90	90	90	90
Heavy Vehicles, %	2	2	2	2	2	2
Mvmt Flow	0	0	153	640	23	0















Major/Minor	Major2	Minor1		
Conflicting Flow All	0	0	626	-
Stage 1	-	-	0	-
Stage 2	-	-	626	-
Critical Hdwy	4.14	-	6.84	-
Critical Hdwy Stg 1	-	-	-	-
Critical Hdwy Stg 2	-	-	5.84	-
Follow-up Hdwy	2.22	-	3.52	-
Pot Cap-1 Maneuver	-	-	416	0
Stage 1	-	-	-	0
Stage 2	-	-	495	0
Platoon blocked, %			-	
Mov Cap-1 Maneuver	-	-	416	-
Mov Cap-2 Maneuver	-	-	416	-
Stage 1	-	-	-	-
Stage 2	-	-	495	-

Approach	WB	NB
HCM Ctrl Dly, s/v		14.2
HCM LOS		B

Minor Lane/Major Mvmt	NBLn1	WBL	WBT
Capacity (veh/h)	416	-	-
HCM Lane V/C Ratio	0.056	-	-
HCM Ctrl Dly (s/v)	14.2	-	-
HCM Lane LOS	B	-	-
HCM 95th %tile Q (veh)	0.2	-	-

Lanes, Volumes, Timings
4: Hedge Street & Curtis Street

No-Build (2028) PM
Burdette North TIS

												
Lane Group	EBL	EBT	EBR	WBL	WBT	WBR	NBL	NBT	NBR	SBL	SBT	SBR
Lane Configurations												
Traffic Volume (vph)	17	926	153	0	0	0	0	29	281	114	10	0
Future Volume (vph)	17	926	153	0	0	0	0	29	281	114	10	0
Ideal Flow (vphpl)	1900	1900	1900	1900	1900	1900	1900	1900	1900	1900	1900	1900
Lane Util. Factor	0.95	0.95	0.95	1.00	1.00	1.00	1.00	1.00	1.00	1.00	1.00	1.00
Fr _t		0.979						0.878				
Fl _t Protected		0.999									0.956	
Satd. Flow (prot)	0	3461	0	0	0	0	0	1635	0	0	1781	0
Fl _t Permitted		0.999									0.956	
Satd. Flow (perm)	0	3461	0	0	0	0	0	1635	0	0	1781	0
Right Turn on Red			Yes			Yes			Yes			Yes
Satd. Flow (RTOR)		23						165				
Link Speed (mph)		25			25			25			25	
Link Distance (ft)		379			1213			1024			568	
Travel Time (s)		10.3			33.1			27.9			15.5	
Peak Hour Factor	0.90	0.90	0.90	0.90	0.90	0.90	0.90	0.90	0.90	0.90	0.90	0.90
Adj. Flow (vph)	19	1029	170	0	0	0	0	32	312	127	11	0
Shared Lane Traffic (%)												
Lane Group Flow (vph)	0	1218	0	0	0	0	0	344	0	0	138	0
Enter Blocked Intersection	No	No	No	No	No	No	No	No	No	No	No	No
Lane Alignment	Left	Left	Right	Left	Left	Right	Left	Left	Right	Left	Left	Right
Median Width(ft)		0			0			0			0	
Link Offset(ft)		0			0			0			0	
Crosswalk Width(ft)		16			16			16			16	
Two way Left Turn Lane												
Headway Factor	1.00	1.00	1.00	1.00	1.00	1.00	1.00	1.00	1.00	1.00	1.00	1.00
Turning Speed (mph)	15		9	15		9	15		9	15		9
Number of Detectors	1	2						1		1	1	
Detector Template	Left	Thru								Left		
Leading Detector (ft)	20	100						30		20	30	
Trailing Detector (ft)	0	0						0		0	0	
Detector 1 Position(ft)	0	0						0		0	0	
Detector 1 Size(ft)	20	6						30		20	30	
Detector 1 Type	Cl+Ex	Cl+Ex						Cl+Ex		Cl+Ex	Cl+Ex	
Detector 1 Channel												
Detector 1 Extend (s)	0.0	0.0						0.0		0.0	0.0	
Detector 1 Queue (s)	0.0	0.0						0.0		0.0	0.0	
Detector 1 Delay (s)	0.0	0.0						0.0		0.0	0.0	
Detector 2 Position(ft)		94										
Detector 2 Size(ft)		6										
Detector 2 Type		Cl+Ex										
Detector 2 Channel												
Detector 2 Extend (s)		0.0										
Turn Type	Perm	NA						NA		Split	NA	
Protected Phases		2						4		8	8	
Permitted Phases	2											
Detector Phase	2	2						4		8	8	
Switch Phase												
Minimum Initial (s)	7.0	7.0						7.0		7.0	7.0	

Lanes, Volumes, Timings
4: Hedge Street & Curtis Street

No-Build (2028) PM
Burdette North TIS

Lane Group	EBL	EBT	EBR	WBL	WBT	WBR	NBL	NBT	NBR	SBL	SBT	SBR
Minimum Split (s)	22.5	22.5						22.5		22.5	22.5	
Total Split (s)	49.2	49.2						28.0		22.8	22.8	
Total Split (%)	49.2%	49.2%						28.0%		22.8%	22.8%	
Maximum Green (s)	44.7	44.7						23.5		18.3	18.3	
Yellow Time (s)	3.5	3.5						3.5		3.5	3.5	
All-Red Time (s)	1.0	1.0						1.0		1.0	1.0	
Lost Time Adjust (s)		0.0						0.0			0.0	
Total Lost Time (s)		4.5						4.5			4.5	
Lead/Lag												
Lead-Lag Optimize?												
Vehicle Extension (s)	3.0	3.0						3.0		3.0	3.0	
Recall Mode	C-Max	C-Max						None		None	None	
Walk Time (s)	7.0	7.0						7.0		7.0	7.0	
Flash Don't Walk (s)	11.0	11.0						11.0		11.0	11.0	
Pedestrian Calls (#/hr)	0	0						0		0	0	
Act Effct Green (s)		56.8						16.7			13.0	
Actuated g/C Ratio		0.57						0.17			0.13	
v/c Ratio		0.62						0.84			0.60	
Control Delay (s/veh)		9.8						38.3			51.2	
Queue Delay		0.5						0.0			0.0	
Total Delay (s/veh)		10.2						38.3			51.2	
LOS		B						D			D	
Approach Delay (s/veh)		10.2						38.3			51.2	
Approach LOS		B						D			D	

Intersection Summary















Area Type:	Other
Cycle Length:	100
Actuated Cycle Length:	100
Offset:	0 (0%), Referenced to phase 2:EBTL, Start of Green
Natural Cycle:	80
Control Type:	Actuated-Coordinated
Maximum v/c Ratio:	0.84
Intersection Signal Delay (s/veh):	19.2
Intersection LOS:	B
Intersection Capacity Utilization:	67.9%
ICU Level of Service:	C
Analysis Period (min):	15

Splits and Phases: 4: Hedge Street & Curtis Street



Lanes, Volumes, Timings
5: Main Street & College Street

No-Build (2028) PM
Burdette North TIS

												
Lane Group	EBL	EBT	EBR	WBL	WBT	WBR	NBL	NBT	NBR	SBL	SBT	SBR
Lane Configurations												
Traffic Volume (vph)	0	0	0	59	445	4	45	3	0	0	15	30
Future Volume (vph)	0	0	0	59	445	4	45	3	0	0	15	30
Ideal Flow (vphpl)	1900	1900	1900	1900	1900	1900	1900	1900	1900	1900	1900	1900
Lane Util. Factor	1.00	1.00	1.00	0.95	0.95	0.95	1.00	1.00	1.00	1.00	1.00	1.00
Frt					0.999						0.911	
Flt Protected					0.994			0.955				
Satd. Flow (prot)	0	0	0	0	3514	0	0	1779	0	0	1697	0
Flt Permitted					0.994			0.955				
Satd. Flow (perm)	0	0	0	0	3514	0	0	1779	0	0	1697	0
Link Speed (mph)		25			25			25			25	
Link Distance (ft)		1082			82			565			1260	
Travel Time (s)		29.5			2.2			15.4			34.4	
Peak Hour Factor	0.90	0.90	0.90	0.90	0.90	0.90	0.90	0.90	0.90	0.90	0.90	0.90
Adj. Flow (vph)	0	0	0	66	494	4	50	3	0	0	17	33
Shared Lane Traffic (%)												
Lane Group Flow (vph)	0	0	0	0	564	0	0	53	0	0	50	0
Enter Blocked Intersection	No	No	No	No	No	No	No	No	No	No	No	No
Lane Alignment	Left	Left	Right	Left	Left	Right	Left	Left	Right	Left	Left	Right
Median Width(ft)		0			0			0			0	
Link Offset(ft)		0			0			0			0	
Crosswalk Width(ft)		16			16			16			16	
Two way Left Turn Lane												
Headway Factor	1.00	1.00	1.00	1.00	1.00	1.00	1.00	1.00	1.00	1.00	1.00	1.00
Turning Speed (mph)	15		9	15		9	15		9	15		9
Sign Control		Free			Free			Stop			Stop	
Intersection Summary												
Area Type:	Other											
Control Type:	Unsignalized											
Intersection Capacity Utilization	30.1%			ICU Level of Service A								
Analysis Period (min)	15											

Intersection												
Int Delay, s/veh	1.9											
Movement	EBL	EBT	EBR	WBL	WBT	WBR	NBL	NBT	NBR	SBL	SBT	SBR
Lane Configurations					↔			↔			↔	
Traffic Vol, veh/h	0	0	0	59	445	4	45	3	0	0	15	30
Future Vol, veh/h	0	0	0	59	445	4	45	3	0	0	15	30
Conflicting Peds, #/hr	0	0	0	0	0	0	0	0	0	0	0	0
Sign Control	Free	Free	Free	Free	Free	Free	Stop	Stop	Stop	Stop	Stop	Stop
RT Channelized	-	-	None	-	-	None	-	-	None	-	-	None
Storage Length	-	-	-	-	-	-	-	-	-	-	-	-
Veh in Median Storage, #	-	0	-	-	0	-	-	0	-	-	0	-
Grade, %	-	0	-	-	0	-	-	0	-	-	0	-
Peak Hour Factor	90	90	90	90	90	90	90	90	90	90	90	90
Heavy Vehicles, %	2	2	2	2	2	2	2	2	2	2	2	2
Mvmt Flow	0	0	0	66	494	4	50	3	0	0	17	33















Major/Minor	Major2	Minor1	Minor2
Conflicting Flow All	0	0	388 630
Stage 1	-	-	0 0
Stage 2	-	-	388 630
Critical Hdwy	4.14	-	7.54 6.54
Critical Hdwy Stg 1	-	-	- 5.54
Critical Hdwy Stg 2	-	-	6.54 5.54
Follow-up Hdwy	2.22	-	3.52 4.02
Pot Cap-1 Maneuver	-	-	545 397
Stage 1	-	-	0 0 474
Stage 2	-	-	607 473
Platoon blocked, %	-	-	-
Mov Cap-1 Maneuver	-	-	504 397
Mov Cap-2 Maneuver	-	-	504 397
Stage 1	-	-	- 474
Stage 2	-	-	560 473

Approach	WB	NB	SB
HCM Ctrl Dly, s/v		13.1	11.8
HCM LOS		B	B

Minor Lane/Major Mvmt	NBLn1	WBL	WBT	WBR	SBLn1
Capacity (veh/h)	496	-	-	-	580
HCM Lane V/C Ratio	0.108	-	-	-	0.086
HCM Ctrl Dly (s/v)	13.1	-	-	-	11.8
HCM Lane LOS	B	-	-	-	B
HCM 95th %tile Q (veh)	0.4	-	-	-	0.3

Lanes, Volumes, Timings
6: Main Street & Curtis Street

No-Build (2028) PM
Burdette North TIS

												
Lane Group	EBL	EBT	EBR	WBL	WBT	WBR	NBL	NBT	NBR	SBL	SBT	SBR
Lane Configurations												
Traffic Volume (vph)	7	501	4	0	0	0	0	3	31	27	31	0
Future Volume (vph)	7	501	4	0	0	0	0	3	31	27	31	0
Ideal Flow (vphpl)	1900	1900	1900	1900	1900	1900	1900	1900	1900	1900	1900	1900
Lane Util. Factor	0.95	0.95	0.95	1.00	1.00	1.00	1.00	1.00	1.00	1.00	1.00	1.00
Fr _t		0.999						0.876				
Fl _t Protected		0.999									0.977	
Satd. Flow (prot)	0	3532	0	0	0	0	0	1632	0	0	1820	0
Fl _t Permitted		0.999									0.977	
Satd. Flow (perm)	0	3532	0	0	0	0	0	1632	0	0	1820	0
Link Speed (mph)		25			25			25			25	
Link Distance (ft)		1197			85			1027			565	
Travel Time (s)		32.6			2.3			28.0			15.4	
Peak Hour Factor	0.90	0.90	0.90	0.90	0.90	0.90	0.90	0.90	0.90	0.90	0.90	0.90
Adj. Flow (vph)	8	557	4	0	0	0	0	3	34	30	34	0
Shared Lane Traffic (%)												
Lane Group Flow (vph)	0	569	0	0	0	0	0	37	0	0	64	0
Enter Blocked Intersection	No	No	No	No	No	No	No	No	No	No	No	No
Lane Alignment	Left	Left	Right	Left	Left	Right	Left	Left	Right	Left	Left	Right
Median Width(ft)		0			0			0			0	
Link Offset(ft)		0			0			0			0	
Crosswalk Width(ft)		16			16			16			16	
Two way Left Turn Lane												
Headway Factor	1.00	1.00	1.00	1.00	1.00	1.00	1.00	1.00	1.00	1.00	1.00	1.00
Turning Speed (mph)	15		9	15		9	15		9	15		9
Sign Control		Free			Free			Stop			Stop	
Intersection Summary												
Area Type:	Other											
Control Type:	Unsignalized											
Intersection Capacity Utilization	30.6%						ICU Level of Service A					
Analysis Period (min)	15											

Intersection												
Int Delay, s/veh	1.9											
Movement	EBL	EBT	EBR	WBL	WBT	WBR	NBL	NBT	NBR	SBL	SBT	SBR
Lane Configurations		↔↔						↔			↔	
Traffic Vol, veh/h	7	501	4	0	0	0	0	3	31	27	31	0
Future Vol, veh/h	7	501	4	0	0	0	0	3	31	27	31	0
Conflicting Peds, #/hr	0	0	0	0	0	0	0	0	0	0	0	0
Sign Control	Free	Free	Free	Free	Free	Free	Stop	Stop	Stop	Stop	Stop	Stop
RT Channelized	-	-	None	-	-	None	-	-	None	-	-	None
Storage Length	-	-	-	-	-	-	-	-	-	-	-	-
Veh in Median Storage, #	-	0	-	-	0	-	-	0	-	-	0	-
Grade, %	-	0	-	-	0	-	-	0	-	-	0	-
Peak Hour Factor	90	90	90	90	90	90	90	90	90	90	90	90
Heavy Vehicles, %	2	2	2	2	2	2	2	2	2	2	2	2
Mvmt Flow	8	557	4	0	0	0	0	3	34	30	34	0

Major/Minor	Major1			Minor1			Minor2		
Conflicting Flow All	0	0	0	-	575	281	296	577	-
Stage 1	-	-	-	-	575	-	0	0	-
Stage 2	-	-	-	-	0	-	296	577	-
Critical Hdwy	4.14	-	-	-	6.54	6.94	7.54	6.54	-
Critical Hdwy Stg 1	-	-	-	-	5.54	-	-	-	-
Critical Hdwy Stg 2	-	-	-	-	-	-	6.54	5.54	-
Follow-up Hdwy	2.22	-	-	-	4.02	3.32	3.52	4.02	-
Pot Cap-1 Maneuver	-	-	-	0	427	716	634	426	0
Stage 1	-	-	-	0	501	-	-	-	0
Stage 2	-	-	-	0	-	-	688	500	0
Platoon blocked, %	-	-	-	-	-	-	-	-	-
Mov Cap-1 Maneuver	-	-	-	-	427	716	600	426	-
Mov Cap-2 Maneuver	-	-	-	-	427	-	600	426	-
Stage 1	-	-	-	-	501	-	-	-	-
Stage 2	-	-	-	-	-	-	651	500	-

Approach	EB	NB	SB
HCM Ctrl Dly, s/v		10.6	13.4
HCM LOS		B	B

Minor Lane/Major Mvmt	NBLn1	EBL	EBT	EBR	SBLn1
Capacity (veh/h)	676	-	-	-	492
HCM Lane V/C Ratio	0.056	-	-	-	0.131
HCM Ctrl Dly (s/v)	10.6	-	-	-	13.4
HCM Lane LOS	B	-	-	-	B
HCM 95th %tile Q (veh)	0.2	-	-	-	0.4

Lanes, Volumes, Timings
 1: NE Main Street (SC 417) & College Street

Build (2028) AM
 Burdette North TIS



Lane Group	EBL	EBT	EBR	WBL	WBT	WBR	NBL	NBT	NBR	SBL	SBT	SBR
Lane Configurations					⇄		↗	↖			↘	↙
Traffic Volume (vph)	0	0	0	129	472	352	30	495	0	0	620	42
Future Volume (vph)	0	0	0	129	472	352	30	495	0	0	620	42
Ideal Flow (vphpl)	1900	1900	1900	1900	1900	1900	1900	1900	1900	1900	1900	1900
Storage Length (ft)	0		0	0		0	150		0	125		0
Storage Lanes	0		0	0		0	1		0	0		0
Taper Length (ft)	100			100			100			100		
Lane Util. Factor	1.00	1.00	1.00	0.95	0.95	0.95	1.00	1.00	1.00	1.00	1.00	1.00
Frt					0.945							0.991
Flt Protected					0.993		0.950					
Satd. Flow (prot)	0	0	0	0	3321	0	1770	1863	0	0	1846	0
Flt Permitted					0.993		0.179					
Satd. Flow (perm)	0	0	0	0	3321	0	333	1863	0	0	1846	0
Right Turn on Red			Yes			Yes			Yes			Yes
Satd. Flow (RTOR)					128							5
Link Speed (mph)		25			25			35				35
Link Distance (ft)		82			314			570				1253
Travel Time (s)		2.2			8.6			11.1				24.4
Peak Hour Factor	0.90	0.90	0.90	0.90	0.90	0.90	0.90	0.90	0.90	0.90	0.90	0.90
Adj. Flow (vph)	0	0	0	143	524	391	33	550	0	0	689	47
Shared Lane Traffic (%)												
Lane Group Flow (vph)	0	0	0	0	1058	0	33	550	0	0	736	0
Enter Blocked Intersection	No	No	No	No	No	No	No	No	No	No	No	No
Lane Alignment	Left	Left	Right	Left	Left	Right	Left	Left	Right	Left	Left	Right
Median Width(ft)		0			0			12				12
Link Offset(ft)		0			0			0				0
Crosswalk Width(ft)		16			16			16				16
Two way Left Turn Lane												
Headway Factor	1.00	1.00	1.00	1.00	1.00	1.00	1.00	1.00	1.00	1.00	1.00	1.00
Turning Speed (mph)	15		9	15		9	15		9	15		9
Number of Detectors				1	2		1	2				2
Detector Template				Left	Thru		Left	Thru				Thru
Leading Detector (ft)				20	100		20	100				100
Trailing Detector (ft)				0	0		0	0				0
Detector 1 Position(ft)				0	0		0	0				0
Detector 1 Size(ft)				20	6		20	6				6
Detector 1 Type				Cl+Ex	Cl+Ex		Cl+Ex	Cl+Ex				Cl+Ex
Detector 1 Channel												
Detector 1 Extend (s)				0.0	0.0		0.0	0.0				0.0
Detector 1 Queue (s)				0.0	0.0		0.0	0.0				0.0
Detector 1 Delay (s)				0.0	0.0		0.0	0.0				0.0
Detector 2 Position(ft)					94			94				94
Detector 2 Size(ft)					6			6				6
Detector 2 Type					Cl+Ex			Cl+Ex				Cl+Ex
Detector 2 Channel												
Detector 2 Extend (s)					0.0			0.0				0.0
Turn Type				Perm	NA		pm+pt	NA				NA
Protected Phases					8		5	2				6
Permitted Phases				8			2					

Lanes, Volumes, Timings
 1: NE Main Street (SC 417) & College Street

Build (2028) AM
 Burdette North TIS



Lane Group	EBL	EBT	EBR	WBL	WBT	WBR	NBL	NBT	NBR	SBL	SBT	SBR
Detector Phase				8	8		5	2			6	
Switch Phase												
Minimum Initial (s)				7.0	7.0		5.0	12.0			12.0	
Minimum Split (s)				22.5	22.5		9.5	22.5			22.5	
Total Split (s)				38.0	38.0		9.6	62.0			52.4	
Total Split (%)				38.0%	38.0%		9.6%	62.0%			52.4%	
Maximum Green (s)				33.5	33.5		5.1	57.5			47.9	
Yellow Time (s)				3.5	3.5		3.5	3.5			3.5	
All-Red Time (s)				1.0	1.0		1.0	1.0			1.0	
Lost Time Adjust (s)					0.0		0.0	0.0			0.0	
Total Lost Time (s)					4.5		4.5	4.5			4.5	
Lead/Lag							Lag				Lead	
Lead-Lag Optimize?							Yes				Yes	
Vehicle Extension (s)				3.0	3.0		3.0	3.0			3.0	
Recall Mode				None	None		None	C-Max			C-Max	
Walk Time (s)				7.0	7.0			7.0			7.0	
Flash Don't Walk (s)				11.0	11.0			11.0			11.0	
Pedestrian Calls (#/hr)				0	0			0			0	
Act Effct Green (s)					32.7		58.3	58.3			52.5	
Actuated g/C Ratio					0.33		0.58	0.58			0.53	
v/c Ratio					0.90		0.12	0.51			0.76	
Control Delay (s/veh)					39.8		3.1	4.0			26.5	
Queue Delay					0.0		0.0	0.1			0.0	
Total Delay (s/veh)					39.8		3.1	4.2			26.5	
LOS					D		A	A			C	
Approach Delay (s/veh)					39.8			4.1			26.5	
Approach LOS					D			A			C	

Intersection Summary

Area Type: Other
 Cycle Length: 100
 Actuated Cycle Length: 100
 Offset: 14 (14%), Referenced to phase 2:NBTL and 6:SBT, Start of Green
 Natural Cycle: 80
 Control Type: Actuated-Coordinated
 Maximum v/c Ratio: 0.90
 Intersection Signal Delay (s/veh): 26.9 Intersection LOS: C
 Intersection Capacity Utilization 78.7% ICU Level of Service D
 Analysis Period (min) 15

Splits and Phases: 1: NE Main Street (SC 417) & College Street

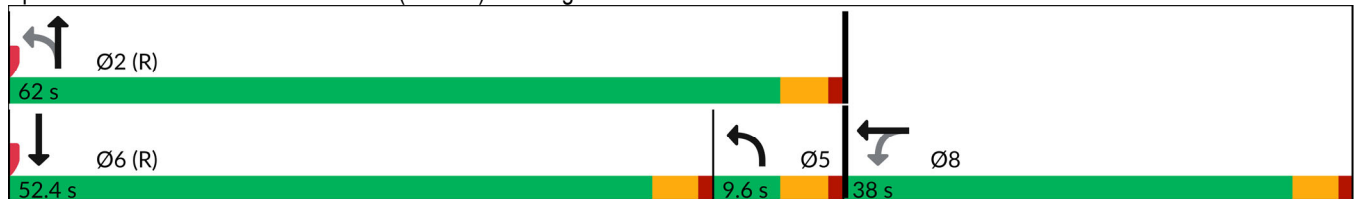

Lanes, Volumes, Timings
2: NE Main Street (SC 417) & Curtis Street

Build (2028) AM
Burdette North TIS



Lane Group	EBL	EBT	EBR	WBL	WBT	WBR	NBL	NBT	NBR	SBL	SBT	SBR
Lane Configurations		↔↔						↔		↔	↔	
Traffic Volume (vph)	65	339	27	0	0	0	0	441	67	199	540	0
Future Volume (vph)	65	339	27	0	0	0	0	441	67	199	540	0
Ideal Flow (vphpl)	1900	1900	1900	1900	1900	1900	1900	1900	1900	1900	1900	1900
Storage Length (ft)	0		0	0		0	150		0	225		0
Storage Lanes	0		0	0		0	0		0	1		0
Taper Length (ft)	100			100			100			100		
Lane Util. Factor	0.95	0.95	0.95	1.00	1.00	1.00	1.00	1.00	1.00	1.00	1.00	1.00
Frt		0.991						0.982				
Flt Protected		0.993								0.950		
Satd. Flow (prot)	0	3483	0	0	0	0	0	1829	0	1770	1863	0
Flt Permitted		0.993								0.326		
Satd. Flow (perm)	0	3483	0	0	0	0	0	1829	0	607	1863	0
Right Turn on Red			Yes			Yes			Yes			Yes
Satd. Flow (RTOR)		6						11				
Link Speed (mph)		25			25			35			35	
Link Distance (ft)		85			379			1084			570	
Travel Time (s)		2.3			10.3			21.1			11.1	
Peak Hour Factor	0.90	0.90	0.90	0.90	0.90	0.90	0.90	0.90	0.90	0.90	0.90	0.90
Adj. Flow (vph)	72	377	30	0	0	0	0	490	74	221	600	0
Shared Lane Traffic (%)												
Lane Group Flow (vph)	0	479	0	0	0	0	0	564	0	221	600	0
Enter Blocked Intersection	No	No	No	No	No	No	No	No	No	No	No	No
Lane Alignment	Left	Left	Right	Left	Left	Right	Left	Left	Right	Left	Left	Right
Median Width(ft)		0			0			12			12	
Link Offset(ft)		0			0			0			0	
Crosswalk Width(ft)		16			16			16			16	
Two way Left Turn Lane												
Headway Factor	1.00	1.00	1.00	1.00	1.00	1.00	1.00	1.00	1.00	1.00	1.00	1.00
Turning Speed (mph)	15		9	15		9	15		9	15		9
Number of Detectors	1	2						2		1	2	
Detector Template	Left	Thru						Thru		Left	Thru	
Leading Detector (ft)	20	100						100		20	100	
Trailing Detector (ft)	0	0						0		0	0	
Detector 1 Position(ft)	0	0						0		0	0	
Detector 1 Size(ft)	20	6						6		20	6	
Detector 1 Type	Cl+Ex	Cl+Ex						Cl+Ex		Cl+Ex	Cl+Ex	
Detector 1 Channel												
Detector 1 Extend (s)	0.0	0.0						0.0		0.0	0.0	
Detector 1 Queue (s)	0.0	0.0						0.0		0.0	0.0	
Detector 1 Delay (s)	0.0	0.0						0.0		0.0	0.0	
Detector 2 Position(ft)		94						94			94	
Detector 2 Size(ft)		6						6			6	
Detector 2 Type		Cl+Ex						Cl+Ex			Cl+Ex	
Detector 2 Channel												
Detector 2 Extend (s)		0.0						0.0			0.0	
Turn Type	Perm	NA						NA		pm+pt	NA	
Protected Phases		4						2		1	6	
Permitted Phases		4								6		

Lanes, Volumes, Timings
2: NE Main Street (SC 417) & Curtis Street

Build (2028) AM
Burdette North TIS

Lane Group	EBL	EBT	EBR	WBL	WBT	WBR	NBL	NBT	NBR	SBL	SBT	SBR
Detector Phase	4	4						2		1	6	
Switch Phase												
Minimum Initial (s)	7.0	7.0						12.0		5.0	12.0	
Minimum Split (s)	22.5	22.5						22.5		9.5	22.5	
Total Split (s)	27.0	27.0						55.0		18.0	73.0	
Total Split (%)	27.0%	27.0%						55.0%		18.0%	73.0%	
Maximum Green (s)	22.5	22.5						50.5		13.5	68.5	
Yellow Time (s)	3.5	3.5						3.5		3.5	3.5	
All-Red Time (s)	1.0	1.0						1.0		1.0	1.0	
Lost Time Adjust (s)		0.0						0.0		0.0	0.0	
Total Lost Time (s)		4.5						4.5		4.5	4.5	
Lead/Lag								Lead		Lag		
Lead-Lag Optimize?								Yes		Yes		
Vehicle Extension (s)	3.0	3.0						3.0		3.0	3.0	
Recall Mode	None	None						C-Max		None	C-Max	
Walk Time (s)	7.0	7.0						7.0			7.0	
Flash Don't Walk (s)	11.0	11.0						11.0			11.0	
Pedestrian Calls (#/hr)	0	0						0			0	
Act Effct Green (s)		18.9						54.1		72.1	72.1	
Actuated g/C Ratio		0.19						0.54		0.72	0.72	
v/c Ratio		0.72						0.57		0.37	0.45	
Control Delay (s/veh)		44.0						18.4		2.7	2.2	
Queue Delay		0.0						0.0		0.0	0.3	
Total Delay (s/veh)		44.0						18.4		2.7	2.5	
LOS		D						B		A	A	
Approach Delay (s/veh)		44.0						18.4			2.6	
Approach LOS		D						B			A	

Intersection Summary

Area Type: Other
 Cycle Length: 100
 Actuated Cycle Length: 100
 Offset: 9 (9%), Referenced to phase 2:NBT and 6:SBTL, Start of Green
 Natural Cycle: 60
 Control Type: Actuated-Coordinated
 Maximum v/c Ratio: 0.72
 Intersection Signal Delay (s/veh): 18.0 Intersection LOS: B
 Intersection Capacity Utilization 78.7% ICU Level of Service D
 Analysis Period (min) 15

Splits and Phases: 2: NE Main Street (SC 417) & Curtis Street

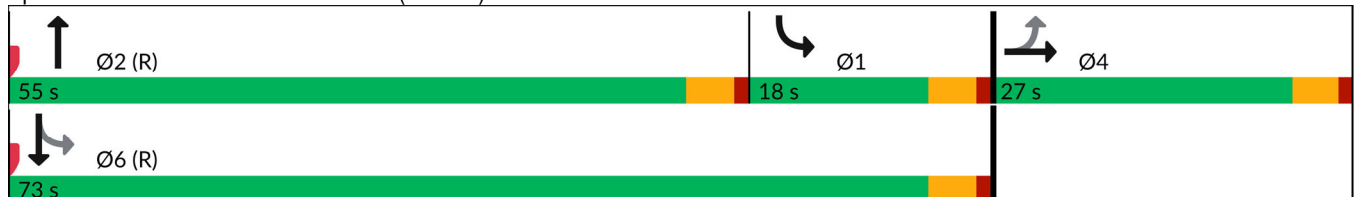

Lanes, Volumes, Timings
3: Hedge Street & College Street

Build (2028) AM
Burdette North TIS



Lane Group	EBT	EBR	WBL	WBT	NBL	NBR
Lane Configurations				↑↑	↑	
Traffic Volume (vph)	0	0	217	893	31	0
Future Volume (vph)	0	0	217	893	31	0
Ideal Flow (vphpl)	1900	1900	1900	1900	1900	1900
Lane Util. Factor	1.00	1.00	0.95	0.95	1.00	1.00
Fr						
Flt Protected				0.990	0.950	
Satd. Flow (prot)	0	0	0	3504	1770	0
Flt Permitted				0.990	0.950	
Satd. Flow (perm)	0	0	0	3504	1770	0
Link Speed (mph)	25			25	25	
Link Distance (ft)	99			1158	256	
Travel Time (s)	2.7			31.6	7.0	
Peak Hour Factor	0.90	0.90	0.90	0.90	0.90	0.90
Adj. Flow (vph)	0	0	241	992	34	0
Shared Lane Traffic (%)						
Lane Group Flow (vph)	0	0	0	1233	34	0
Enter Blocked Intersection	No	No	No	No	No	No
Lane Alignment	Left	Right	Left	Left	Left	Right
Median Width(ft)	0			0	12	
Link Offset(ft)	0			0	0	
Crosswalk Width(ft)	16			16	16	
Two way Left Turn Lane						
Headway Factor	1.00	1.00	1.00	1.00	1.00	1.00
Turning Speed (mph)		9	15		15	9
Sign Control	Free			Free	Stop	

Intersection Summary

Area Type:	Other
Control Type:	Unsignalized
Intersection Capacity Utilization	41.0%
Analysis Period (min)	15
	ICU Level of Service A

Intersection						
Int Delay, s/veh	0.6					
Movement	EBT	EBR	WBL	WBT	NBL	NBR
Lane Configurations				↑↑	↑	
Traffic Vol, veh/h	0	0	217	893	31	0
Future Vol, veh/h	0	0	217	893	31	0
Conflicting Peds, #/hr	0	0	0	0	0	0
Sign Control	Free	Free	Free	Free	Stop	Stop
RT Channelized	-	None	-	None	-	None
Storage Length	-	-	-	-	0	-
Veh in Median Storage, #	0	-	-	0	0	-
Grade, %	0	-	-	0	0	-
Peak Hour Factor	90	90	90	90	90	90
Heavy Vehicles, %	2	2	2	2	2	2
Mvmt Flow	0	0	241	992	34	0

Major/Minor	Major2	Minor1		
Conflicting Flow All	0	0	978	-
Stage 1	-	-	0	-
Stage 2	-	-	978	-
Critical Hdwy	4.14	-	6.84	-
Critical Hdwy Stg 1	-	-	-	-
Critical Hdwy Stg 2	-	-	5.84	-
Follow-up Hdwy	2.22	-	3.52	-
Pot Cap-1 Maneuver	-	-	248	0
Stage 1	-	-	-	0
Stage 2	-	-	325	0
Platoon blocked, %			-	
Mov Cap-1 Maneuver	-	-	248	-
Mov Cap-2 Maneuver	-	-	248	-
Stage 1	-	-	-	-
Stage 2	-	-	325	-

Approach	WB	NB
HCM Ctrl Dly, s/v		21.8
HCM LOS		C

Minor Lane/Major Mvmt	NBLn1	WBL	WBT
Capacity (veh/h)	248	-	-
HCM Lane V/C Ratio	0.139	-	-
HCM Ctrl Dly (s/v)	21.8	-	-
HCM Lane LOS	C	-	-
HCM 95th %tile Q (veh)	0.5	-	-

Lanes, Volumes, Timings
4: Hedge Street & Curtis Street

Build (2028) AM
Burdette North TIS



Lane Group	EBL	EBT	EBR	WBL	WBT	WBR	NBL	NBT	NBR	SBL	SBT	SBR
Lane Configurations		↔↔						↔			↔	
Traffic Volume (vph)	23	501	54	0	0	0	0	31	194	49	185	0
Future Volume (vph)	23	501	54	0	0	0	0	31	194	49	185	0
Ideal Flow (vphpl)	1900	1900	1900	1900	1900	1900	1900	1900	1900	1900	1900	1900
Lane Util. Factor	0.95	0.95	0.95	1.00	1.00	1.00	1.00	1.00	1.00	1.00	1.00	1.00
Fr _t		0.986						0.883				
Fl _t Protected		0.998									0.990	
Satd. Flow (prot)	0	3483	0	0	0	0	0	1645	0	0	1844	0
Fl _t Permitted		0.998									0.990	
Satd. Flow (perm)	0	3483	0	0	0	0	0	1645	0	0	1844	0
Right Turn on Red			Yes			Yes			Yes			Yes
Satd. Flow (RTOR)		12						216				
Link Speed (mph)		25			25			25			25	
Link Distance (ft)		379			1213			1024			312	
Travel Time (s)		10.3			33.1			27.9			8.5	
Peak Hour Factor	0.90	0.90	0.90	0.90	0.90	0.90	0.90	0.90	0.90	0.90	0.90	0.90
Adj. Flow (vph)	26	557	60	0	0	0	0	34	216	54	206	0
Shared Lane Traffic (%)												
Lane Group Flow (vph)	0	643	0	0	0	0	0	250	0	0	260	0
Enter Blocked Intersection	No	No	No	No	No	No	No	No	No	No	No	No
Lane Alignment	Left	Left	Right	Left	Left	Right	Left	Left	Right	Left	Left	Right
Median Width(ft)		0			0			0			0	
Link Offset(ft)		0			0			0			0	
Crosswalk Width(ft)		16			16			16			16	
Two way Left Turn Lane												
Headway Factor	1.00	1.00	1.00	1.00	1.00	1.00	1.00	1.00	1.00	1.00	1.00	1.00
Turning Speed (mph)	15		9	15		9	15		9	15		9
Number of Detectors	1	2						1		1	1	
Detector Template	Left	Thru								Left		
Leading Detector (ft)	20	100						30		20	30	
Trailing Detector (ft)	0	0						0		0	0	
Detector 1 Position(ft)	0	0						0		0	0	
Detector 1 Size(ft)	20	6						30		20	30	
Detector 1 Type	Cl+Ex	Cl+Ex						Cl+Ex		Cl+Ex	Cl+Ex	
Detector 1 Channel												
Detector 1 Extend (s)	0.0	0.0						0.0		0.0	0.0	
Detector 1 Queue (s)	0.0	0.0						0.0		0.0	0.0	
Detector 1 Delay (s)	0.0	0.0						0.0		0.0	0.0	
Detector 2 Position(ft)		94										
Detector 2 Size(ft)		6										
Detector 2 Type		Cl+Ex										
Detector 2 Channel												
Detector 2 Extend (s)		0.0										
Turn Type	Perm	NA						NA		Split	NA	
Protected Phases		2						4		8	8	
Permitted Phases	2											
Detector Phase	2	2						4		8	8	
Switch Phase												
Minimum Initial (s)	7.0	7.0						7.0		7.0	7.0	

Lanes, Volumes, Timings
4: Hedge Street & Curtis Street

Build (2028) AM
Burdette North TIS

Lane Group	EBL	EBT	EBR	WBL	WBT	WBR	NBL	NBT	NBR	SBL	SBT	SBR
Minimum Split (s)	22.5	22.5						22.5		22.5	22.5	
Total Split (s)	38.0	38.0						29.0		33.0	33.0	
Total Split (%)	38.0%	38.0%						29.0%		33.0%	33.0%	
Maximum Green (s)	33.5	33.5						24.5		28.5	28.5	
Yellow Time (s)	3.5	3.5						3.5		3.5	3.5	
All-Red Time (s)	1.0	1.0						1.0		1.0	1.0	
Lost Time Adjust (s)		0.0						0.0			0.0	
Total Lost Time (s)		4.5						4.5			4.5	
Lead/Lag												
Lead-Lag Optimize?												
Vehicle Extension (s)	3.0	3.0						3.0		3.0	3.0	
Recall Mode	C-Max	C-Max						None		None	None	
Walk Time (s)	7.0	7.0						7.0		7.0	7.0	
Flash Don't Walk (s)	11.0	11.0						11.0		11.0	11.0	
Pedestrian Calls (#/hr)	0	0						0		0	0	
Act Effct Green (s)		57.3						9.8			19.3	
Actuated g/C Ratio		0.57						0.10			0.19	
v/c Ratio		0.32						0.70			0.73	
Control Delay (s/veh)		7.4						19.9			49.5	
Queue Delay		0.2						0.0			0.0	
Total Delay (s/veh)		7.6						19.9			49.5	
LOS		A						B			D	
Approach Delay (s/veh)		7.6						19.9			49.5	
Approach LOS		A						B			D	

Intersection Summary





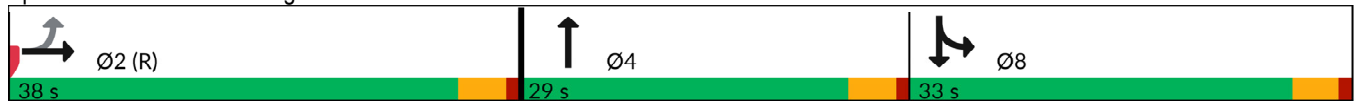









Area Type:	Other
Cycle Length:	100
Actuated Cycle Length:	100
Offset:	76 (76%), Referenced to phase 2:EBTL, Start of Green
Natural Cycle:	70
Control Type:	Actuated-Coordinated
Maximum v/c Ratio:	0.73
Intersection Signal Delay (s/veh):	19.7
Intersection LOS:	B
Intersection Capacity Utilization:	53.5%
ICU Level of Service:	A
Analysis Period (min):	15

Splits and Phases: 4: Hedge Street & Curtis Street



Lanes, Volumes, Timings
5: Main Street & College Street

Build (2028) AM
Burdette North TIS

												
Lane Group	EBL	EBT	EBR	WBL	WBT	WBR	NBL	NBT	NBR	SBL	SBT	SBR
Lane Configurations												
Traffic Volume (vph)	0	0	0	27	508	10	32	5	0	0	1	22
Future Volume (vph)	0	0	0	27	508	10	32	5	0	0	1	22
Ideal Flow (vphpl)	1900	1900	1900	1900	1900	1900	1900	1900	1900	1900	1900	1900
Lane Util. Factor	1.00	1.00	1.00	0.95	0.95	0.95	1.00	1.00	1.00	1.00	1.00	1.00
Frt					0.997						0.870	
Flt Protected					0.998			0.959				
Satd. Flow (prot)	0	0	0	0	3522	0	0	1786	0	0	1621	0
Flt Permitted					0.998			0.959				
Satd. Flow (perm)	0	0	0	0	3522	0	0	1786	0	0	1621	0
Link Speed (mph)		25			25			25			25	
Link Distance (ft)		1082			82			565			1260	
Travel Time (s)		29.5			2.2			15.4			34.4	
Peak Hour Factor	0.90	0.90	0.90	0.90	0.90	0.90	0.90	0.90	0.90	0.90	0.90	0.90
Adj. Flow (vph)	0	0	0	30	564	11	36	6	0	0	1	24
Shared Lane Traffic (%)												
Lane Group Flow (vph)	0	0	0	0	605	0	0	42	0	0	25	0
Enter Blocked Intersection	No	No	No	No	No	No	No	No	No	No	No	No
Lane Alignment	Left	Left	Right	Left	Left	Right	Left	Left	Right	Left	Left	Right
Median Width(ft)		0			0			0			0	
Link Offset(ft)		0			0			0			0	
Crosswalk Width(ft)		16			16			16			16	
Two way Left Turn Lane												
Headway Factor	1.00	1.00	1.00	1.00	1.00	1.00	1.00	1.00	1.00	1.00	1.00	1.00
Turning Speed (mph)	15		9	15		9	15		9	15		9
Sign Control		Free			Free			Stop			Stop	
Intersection Summary												
Area Type:	Other											
Control Type:	Unsignalized											
Intersection Capacity Utilization	30.5%			ICU Level of Service A								
Analysis Period (min)	15											

Intersection												
Int Delay, s/veh	1.2											
Movement	EBL	EBT	EBR	WBL	WBT	WBR	NBL	NBT	NBR	SBL	SBT	SBR
Lane Configurations					↕↕			↕			↕	
Traffic Vol, veh/h	0	0	0	27	508	10	32	5	0	0	1	22
Future Vol, veh/h	0	0	0	27	508	10	32	5	0	0	1	22
Conflicting Peds, #/hr	0	0	0	0	0	0	0	0	0	0	0	0
Sign Control	Free	Free	Free	Free	Free	Free	Stop	Stop	Stop	Stop	Stop	Stop
RT Channelized	-	-	None	-	-	None	-	-	None	-	-	None
Storage Length	-	-	-	-	-	-	-	-	-	-	-	-
Veh in Median Storage, #	-	0	-	-	0	-	-	0	-	-	0	-
Grade, %	-	0	-	-	0	-	-	0	-	-	0	-
Peak Hour Factor	90	90	90	90	90	90	90	90	90	90	90	90
Heavy Vehicles, %	2	2	2	2	2	2	2	2	2	2	2	2
Mvmt Flow	0	0	0	30	564	11	36	6	0	0	1	24















Major/Minor	Major2	Minor1	Minor2
Conflicting Flow All	0	0	343 635
Stage 1	-	-	0 0
Stage 2	-	-	343 635
Critical Hdwy	4.14	-	7.54 6.54
Critical Hdwy Stg 1	-	-	- 5.54
Critical Hdwy Stg 2	-	-	6.54 5.54
Follow-up Hdwy	2.22	-	3.52 4.02
Pot Cap-1 Maneuver	-	-	587 394
Stage 1	-	-	0 0 473
Stage 2	-	-	646 471 0 0
Platoon blocked, %	-	-	-
Mov Cap-1 Maneuver	-	-	565 394
Mov Cap-2 Maneuver	-	-	565 394
Stage 1	-	-	- 473
Stage 2	-	-	622 471

Approach	WB	NB	SB
HCM Ctrl Dly, s/v		12.3	10.5
HCM LOS		B	B

Minor Lane/Major Mvmt	NBLn1	WBL	WBT	WBR	SBLn1
Capacity (veh/h)	534	-	-	-	686
HCM Lane V/C Ratio	0.077	-	-	-	0.037
HCM Ctrl Dly (s/v)	12.3	-	-	-	10.5
HCM Lane LOS	B	-	-	-	B
HCM 95th %tile Q (veh)	0.2	-	-	-	0.1

Lanes, Volumes, Timings
6: Main Street & Curtis Street

Build (2028) AM
Burdette North TIS

												
Lane Group	EBL	EBT	EBR	WBL	WBT	WBR	NBL	NBT	NBR	SBL	SBT	SBR
Lane Configurations												
Traffic Volume (vph)	6	408	13	0	0	0	0	7	20	2	13	0
Future Volume (vph)	6	408	13	0	0	0	0	7	20	2	13	0
Ideal Flow (vphpl)	1900	1900	1900	1900	1900	1900	1900	1900	1900	1900	1900	1900
Lane Util. Factor	0.95	0.95	0.95	1.00	1.00	1.00	1.00	1.00	1.00	1.00	1.00	1.00
Fr _t		0.996						0.901				
Fl _t Protected		0.999									0.994	
Satd. Flow (prot)	0	3522	0	0	0	0	0	1678	0	0	1852	0
Fl _t Permitted		0.999									0.994	
Satd. Flow (perm)	0	3522	0	0	0	0	0	1678	0	0	1852	0
Link Speed (mph)		25			25			25			25	
Link Distance (ft)		1197			85			1027			565	
Travel Time (s)		32.6			2.3			28.0			15.4	
Peak Hour Factor	0.90	0.90	0.90	0.90	0.90	0.90	0.90	0.90	0.90	0.90	0.90	0.90
Adj. Flow (vph)	7	453	14	0	0	0	0	8	22	2	14	0
Shared Lane Traffic (%)												
Lane Group Flow (vph)	0	474	0	0	0	0	0	30	0	0	16	0
Enter Blocked Intersection	No	No	No	No	No	No	No	No	No	No	No	No
Lane Alignment	Left	Left	Right	Left	Left	Right	Left	Left	Right	Left	Left	Right
Median Width(ft)		0			0			0			0	
Link Offset(ft)		0			0			0			0	
Crosswalk Width(ft)		16			16			16			16	
Two way Left Turn Lane												
Headway Factor	1.00	1.00	1.00	1.00	1.00	1.00	1.00	1.00	1.00	1.00	1.00	1.00
Turning Speed (mph)	15		9	15		9	15		9	15		9
Sign Control		Free			Free			Stop			Stop	
Intersection Summary												
Area Type:	Other											
Control Type:	Unsignalized											
Intersection Capacity Utilization	21.9%						ICU Level of Service A					
Analysis Period (min)	15											

Intersection												
Int Delay, s/veh	1											
Movement	EBL	EBT	EBR	WBL	WBT	WBR	NBL	NBT	NBR	SBL	SBT	SBR
Lane Configurations		↔↔						↔			↔	
Traffic Vol, veh/h	6	408	13	0	0	0	0	7	20	2	13	0
Future Vol, veh/h	6	408	13	0	0	0	0	7	20	2	13	0
Conflicting Peds, #/hr	0	0	0	0	0	0	0	0	0	0	0	0
Sign Control	Free	Free	Free	Free	Free	Free	Stop	Stop	Stop	Stop	Stop	Stop
RT Channelized	-	-	None	-	-	None	-	-	None	-	-	None
Storage Length	-	-	-	-	-	-	-	-	-	-	-	-
Veh in Median Storage, #	-	0	-	-	0	-	-	0	-	-	0	-
Grade, %	-	0	-	-	0	-	-	0	-	-	0	-
Peak Hour Factor	90	90	90	90	90	90	90	90	90	90	90	90
Heavy Vehicles, %	2	2	2	2	2	2	2	2	2	2	2	2
Mvmt Flow	7	453	14	0	0	0	0	8	22	2	14	0

Major/Minor	Major1			Minor1			Minor2		
Conflicting Flow All	0	0	0	-	474	234	245	481	-
Stage 1	-	-	-	-	474	-	0	0	-
Stage 2	-	-	-	-	0	-	245	481	-
Critical Hdwy	4.14	-	-	-	6.54	6.94	7.54	6.54	-
Critical Hdwy Stg 1	-	-	-	-	5.54	-	-	-	-
Critical Hdwy Stg 2	-	-	-	-	-	-	6.54	5.54	-
Follow-up Hdwy	2.22	-	-	-	4.02	3.32	3.52	4.02	-
Pot Cap-1 Maneuver	-	-	-	0	488	768	688	483	0
Stage 1	-	-	-	0	556	-	-	-	0
Stage 2	-	-	-	0	-	-	737	552	0
Platoon blocked, %	-	-	-	-	-	-	-	-	-
Mov Cap-1 Maneuver	-	-	-	-	488	768	660	483	-
Mov Cap-2 Maneuver	-	-	-	-	488	-	660	483	-
Stage 1	-	-	-	-	556	-	-	-	-
Stage 2	-	-	-	-	-	-	706	552	-

Approach	EB	NB	SB
HCM Ctrl Dly, s/v		10.6	12.4
HCM LOS		B	B

Minor Lane/Major Mvmt	NBLn1	EBL	EBT	EBR	SBLn1
Capacity (veh/h)	669	-	-	-	501
HCM Lane V/C Ratio	0.045	-	-	-	0.033
HCM Ctrl Dly (s/v)	10.6	-	-	-	12.4
HCM Lane LOS	B	-	-	-	B
HCM 95th %tile Q (veh)	0.1	-	-	-	0.1



Lane Group	EBL	EBR	NBL	NBT	SBT	SBR
Lane Configurations						
Traffic Volume (vph)	7	17	22	32	217	4
Future Volume (vph)	7	17	22	32	217	4
Ideal Flow (vphp)	1900	1900	1900	1900	1900	1900
Lane Util. Factor	1.00	1.00	1.00	1.00	1.00	1.00
Frt	0.905			0.998		
Flt Protected	0.985			0.980		
Satd. Flow (prot)	1660	0	0	1825	1859	0
Flt Permitted	0.985			0.980		
Satd. Flow (perm)	1660	0	0	1825	1859	0
Link Speed (mph)	25			25	25	
Link Distance (ft)	1169			312	256	
Travel Time (s)	31.9			8.5	7.0	
Peak Hour Factor	0.90	0.90	0.90	0.90	0.90	0.90
Adj. Flow (vph)	8	19	24	36	241	4
Shared Lane Traffic (%)						
Lane Group Flow (vph)	27	0	0	60	245	0
Enter Blocked Intersection	No	No	No	No	No	No
Lane Alignment	Left	Right	Left	Left	Left	Right
Median Width(ft)	12			0	0	
Link Offset(ft)	0			0	0	
Crosswalk Width(ft)	16			16	16	
Two way Left Turn Lane						
Headway Factor	1.00	1.00	1.00	1.00	1.00	1.00
Turning Speed (mph)	15	9	15			9
Sign Control	Stop			Free	Free	

Intersection Summary

Area Type:	Other
Control Type:	Unsignalized
Intersection Capacity Utilization	28.3%
Analysis Period (min)	15
	ICU Level of Service A

Intersection						
Int Delay, s/veh	1.4					
Movement	EBL	EBR	NBL	NBT	SBT	SBR
Lane Configurations	T			T		
Traffic Vol, veh/h	7	17	22	32	217	4
Future Vol, veh/h	7	17	22	32	217	4
Conflicting Peds, #/hr	0	0	0	0	0	0
Sign Control	Stop	Stop	Free	Free	Free	Free
RT Channelized	-	None	-	None	-	None
Storage Length	0	-	-	-	-	-
Veh in Median Storage, #	0	-	-	0	0	-
Grade, %	0	-	-	0	0	-
Peak Hour Factor	90	90	90	90	90	90
Heavy Vehicles, %	2	2	2	2	2	2
Mvmt Flow	8	19	24	36	241	4

Major/Minor	Minor2	Major1		Major2	
Conflicting Flow All	327	243	245	0	0
Stage 1	243	-	-	-	-
Stage 2	84	-	-	-	-
Critical Hdwy	6.42	6.22	4.12	-	-
Critical Hdwy Stg 1	5.42	-	-	-	-
Critical Hdwy Stg 2	5.42	-	-	-	-
Follow-up Hdwy	3.518	3.318	2.218	-	-
Pot Cap-1 Maneuver	667	796	1321	-	-
Stage 1	797	-	-	-	-
Stage 2	939	-	-	-	-
Platoon blocked, %				-	-
Mov Cap-1 Maneuver	654	796	1321	-	-
Mov Cap-2 Maneuver	654	-	-	-	-
Stage 1	782	-	-	-	-
Stage 2	939	-	-	-	-

Approach	EB	NB	SB
HCM Ctrl Dly, s/v	10	3.2	0
HCM LOS	B		

Minor Lane/Major Mvmt	NBL	NBT	EBLn1	SBT	SBR
Capacity (veh/h)	1321	-	749	-	-
HCM Lane V/C Ratio	0.019	-	0.036	-	-
HCM Ctrl Dly (s/v)	7.8	0	10	-	-
HCM Lane LOS	A	A	B	-	-
HCM 95th %tile Q (veh)	0.1	-	0.1	-	-

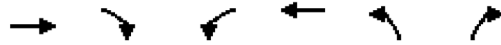

Lane Group	EBT	EBR	WBL	WBT	NBL	NBR
Lane Configurations				↕↕	↕	
Traffic Volume (vph)	0	0	3	921	25	0
Future Volume (vph)	0	0	3	921	25	0
Ideal Flow (vphpl)	1900	1900	1900	1900	1900	1900
Lane Util. Factor	1.00	1.00	0.95	0.95	1.00	1.00
Fr						
Flt Protected					0.950	
Satd. Flow (prot)	0	0	0	3539	1770	0
Flt Permitted					0.950	
Satd. Flow (perm)	0	0	0	3539	1770	0
Link Speed (mph)	25			25	30	
Link Distance (ft)	314			99	1024	
Travel Time (s)	8.6			2.7	23.3	
Peak Hour Factor	0.90	0.90	0.90	0.90	0.90	0.90
Adj. Flow (vph)	0	0	3	1023	28	0
Shared Lane Traffic (%)						
Lane Group Flow (vph)	0	0	0	1026	28	0
Enter Blocked Intersection	No	No	No	No	No	No
Lane Alignment	Left	Right	Left	Left	Left	Right
Median Width(ft)	0			0	12	
Link Offset(ft)	0			0	0	
Crosswalk Width(ft)	16			16	16	
Two way Left Turn Lane						
Headway Factor	1.00	1.00	1.00	1.00	1.00	1.00
Turning Speed (mph)		9	15		15	9
Sign Control	Free			Free	Stop	

Intersection Summary

Area Type:	Other
Control Type:	Unsignalized
Intersection Capacity Utilization	35.5%
Analysis Period (min)	15
	ICU Level of Service A

Intersection						
Int Delay, s/veh	0.3					
Movement	EBT	EBR	WBL	WBT	NBL	NBR
Lane Configurations				↑↑	↑	
Traffic Vol, veh/h	0	0	3	921	25	0
Future Vol, veh/h	0	0	3	921	25	0
Conflicting Peds, #/hr	0	0	0	0	0	0
Sign Control	Free	Free	Free	Free	Stop	Stop
RT Channelized	-	None	-	None	-	None
Storage Length	-	-	-	-	0	-
Veh in Median Storage, #	0	-	-	0	0	-
Grade, %	0	-	-	0	0	-
Peak Hour Factor	90	90	90	90	90	90
Heavy Vehicles, %	2	2	2	2	2	2
Mvmt Flow	0	0	3	1023	28	0

Major/Minor	Major2	Minor1		
Conflicting Flow All	0	0	518	-
Stage 1	-	-	0	-
Stage 2	-	-	518	-
Critical Hdwy	4.14	-	6.84	-
Critical Hdwy Stg 1	-	-	-	-
Critical Hdwy Stg 2	-	-	5.84	-
Follow-up Hdwy	2.22	-	3.52	-
Pot Cap-1 Maneuver	-	-	487	0
Stage 1	-	-	-	0
Stage 2	-	-	563	0
Platoon blocked, %			-	
Mov Cap-1 Maneuver	-	-	487	-
Mov Cap-2 Maneuver	-	-	487	-
Stage 1	-	-	-	-
Stage 2	-	-	563	-

Approach	WB	NB
HCM Ctrl Dly, s/v		12.8
HCM LOS		B

Minor Lane/Major Mvmt	NBLn1	WBL	WBT
Capacity (veh/h)	487	-	-
HCM Lane V/C Ratio	0.057	-	-
HCM Ctrl Dly (s/v)	12.8	-	-
HCM Lane LOS	B	-	-
HCM 95th %tile Q (veh)	0.2	-	-

Lanes, Volumes, Timings
1: NE Main Street (SC 417) & College Street

Build (2028) AM
Burdette North TIS



Lane Group	EBL	EBT	EBR	WBL	WBT	WBR	NBL	NBT	NBR	SBL	SBT	SBR
Lane Configurations					↔↔		↗	↖			↘	↙
Traffic Volume (vph)	0	0	0	85	383	186	59	506	0	0	857	77
Future Volume (vph)	0	0	0	85	383	186	59	506	0	0	857	77
Ideal Flow (vphpl)	1900	1900	1900	1900	1900	1900	1900	1900	1900	1900	1900	1900
Storage Length (ft)	0		0	0		0	150		0	125		0
Storage Lanes	0		0	0		0	1		0	0		0
Taper Length (ft)	100			100			100			100		
Lane Util. Factor	1.00	1.00	1.00	0.95	0.95	0.95	1.00	1.00	1.00	1.00	1.00	1.00
Frt					0.957							0.989
Flt Protected					0.994		0.950					
Satd. Flow (prot)	0	0	0	0	3367	0	1770	1863	0	0	1842	0
Flt Permitted					0.994		0.063					
Satd. Flow (perm)	0	0	0	0	3367	0	117	1863	0	0	1842	0
Right Turn on Red			Yes			Yes			Yes			Yes
Satd. Flow (RTOR)					55							8
Link Speed (mph)		25			25			35				35
Link Distance (ft)		82			313			570				1253
Travel Time (s)		2.2			8.5			11.1				24.4
Peak Hour Factor	0.90	0.90	0.90	0.90	0.90	0.90	0.90	0.90	0.90	0.90	0.90	0.90
Adj. Flow (vph)	0	0	0	94	426	207	66	562	0	0	952	86
Shared Lane Traffic (%)												
Lane Group Flow (vph)	0	0	0	0	727	0	66	562	0	0	1038	0
Enter Blocked Intersection	No	No	No	No	No	No	No	No	No	No	No	No
Lane Alignment	Left	Left	Right	Left	Left	Right	Left	Left	Right	Left	Left	Right
Median Width(ft)		0			0			12				12
Link Offset(ft)		0			0			0				0
Crosswalk Width(ft)		16			16			16				16
Two way Left Turn Lane												
Headway Factor	1.00	1.00	1.00	1.00	1.00	1.00	1.00	1.00	1.00	1.00	1.00	1.00
Turning Speed (mph)	15		9	15		9	15		9	15		9
Number of Detectors				1	2		1	2				2
Detector Template				Left	Thru		Left	Thru				Thru
Leading Detector (ft)				20	100		20	100				100
Trailing Detector (ft)				0	0		0	0				0
Detector 1 Position(ft)				0	0		0	0				0
Detector 1 Size(ft)				20	6		20	6				6
Detector 1 Type				Cl+Ex	Cl+Ex		Cl+Ex	Cl+Ex				Cl+Ex
Detector 1 Channel												
Detector 1 Extend (s)				0.0	0.0		0.0	0.0				0.0
Detector 1 Queue (s)				0.0	0.0		0.0	0.0				0.0
Detector 1 Delay (s)				0.0	0.0		0.0	0.0				0.0
Detector 2 Position(ft)					94			94				94
Detector 2 Size(ft)					6			6				6
Detector 2 Type					Cl+Ex			Cl+Ex				Cl+Ex
Detector 2 Channel												
Detector 2 Extend (s)					0.0			0.0				0.0
Turn Type				Perm	NA		pm+pt	NA				NA
Protected Phases					8		5	2				6
Permitted Phases				8			2					

Lanes, Volumes, Timings
 1: NE Main Street (SC 417) & College Street

Build (2028) AM
 Burdette North TIS



Lane Group	EBL	EBT	EBR	WBL	WBT	WBR	NBL	NBT	NBR	SBL	SBT	SBR
Detector Phase				8	8		5	2			6	
Switch Phase												
Minimum Initial (s)				7.0	7.0		5.0	12.0			12.0	
Minimum Split (s)				22.5	22.5		9.5	22.5			22.5	
Total Split (s)				27.0	27.0		10.0	73.0			63.0	
Total Split (%)				27.0%	27.0%		10.0%	73.0%			63.0%	
Maximum Green (s)				22.5	22.5		5.5	68.5			58.5	
Yellow Time (s)				3.5	3.5		3.5	3.5			3.5	
All-Red Time (s)				1.0	1.0		1.0	1.0			1.0	
Lost Time Adjust (s)					0.0		0.0	0.0			0.0	
Total Lost Time (s)					4.5		4.5	4.5			4.5	
Lead/Lag							Lag				Lead	
Lead-Lag Optimize?							Yes				Yes	
Vehicle Extension (s)				3.0	3.0		3.0	3.0			3.0	
Recall Mode				None	None		None	C-Max			C-Max	
Walk Time (s)				7.0	7.0			7.0			7.0	
Flash Don't Walk (s)				11.0	11.0			11.0			11.0	
Pedestrian Calls (#/hr)				0	0			0			0	
Act Effct Green (s)					22.3		68.7	68.7			60.7	
Actuated g/C Ratio					0.22		0.69	0.69			0.61	
v/c Ratio					0.92		0.39	0.44			0.93	
Control Delay (s/veh)					52.9		13.1	2.0			34.0	
Queue Delay					0.0		0.0	0.5			0.0	
Total Delay (s/veh)					52.9		13.1	2.5			34.0	
LOS					D		B	A			C	
Approach Delay (s/veh)					52.9			3.6			34.0	
Approach LOS					D			A			C	

Intersection Summary

Area Type: Other
 Cycle Length: 100
 Actuated Cycle Length: 100
 Offset: 38 (38%), Referenced to phase 2:NBTL and 6:SBT, Start of Green
 Natural Cycle: 90
 Control Type: Actuated-Coordinated
 Maximum v/c Ratio: 0.93
 Intersection Signal Delay (s/veh): 31.8 Intersection LOS: C
 Intersection Capacity Utilization 85.2% ICU Level of Service E
 Analysis Period (min) 15

Splits and Phases: 1: NE Main Street (SC 417) & College Street



Lanes, Volumes, Timings
2: NE Main Street (SC 417) & Curtis Street

Build (2028) AM
Burdette North TIS



Lane Group	EBL	EBT	EBR	WBL	WBT	WBR	NBL	NBT	NBR	SBL	SBT	SBR
Lane Configurations		↔↔						↔		↔	↔	↔
Traffic Volume (vph)	52	470	51	0	0	0	0	454	233	356	560	0
Future Volume (vph)	52	470	51	0	0	0	0	454	233	356	560	0
Ideal Flow (vphp)	1900	1900	1900	1900	1900	1900	1900	1900	1900	1900	1900	1900
Storage Length (ft)	0		0	0		0	150		0	225		0
Storage Lanes	0		0	0		0	0		0	1		0
Taper Length (ft)	100			100			100			100		
Lane Util. Factor	0.95	0.95	0.95	1.00	1.00	1.00	1.00	1.00	1.00	1.00	1.00	1.00
Frt		0.987						0.954				
Flt Protected		0.995								0.950		
Satd. Flow (prot)	0	3476	0	0	0	0	0	1777	0	1770	1863	0
Flt Permitted		0.995								0.131		
Satd. Flow (perm)	0	3476	0	0	0	0	0	1777	0	244	1863	0
Right Turn on Red			Yes			Yes			Yes			Yes
Satd. Flow (RTOR)		9						35				
Link Speed (mph)		25			25			35				35
Link Distance (ft)		85			379			1084				570
Travel Time (s)		2.3			10.3			21.1				11.1
Peak Hour Factor	0.90	0.90	0.90	0.90	0.90	0.90	0.90	0.90	0.90	0.90	0.90	0.90
Adj. Flow (vph)	58	522	57	0	0	0	0	504	259	396	622	0
Shared Lane Traffic (%)												
Lane Group Flow (vph)	0	637	0	0	0	0	0	763	0	396	622	0
Enter Blocked Intersection	No	No	No	No	No	No	No	No	No	No	No	No
Lane Alignment	Left	Left	Right	Left	Left	Right	Left	Left	Right	Left	Left	Right
Median Width(ft)		0			0			12				12
Link Offset(ft)		0			0			0				0
Crosswalk Width(ft)		16			16			16				16
Two way Left Turn Lane												
Headway Factor	1.00	1.00	1.00	1.00	1.00	1.00	1.00	1.00	1.00	1.00	1.00	1.00
Turning Speed (mph)	15		9	15		9	15		9	15		9
Number of Detectors	1	2						2		1	2	
Detector Template	Left	Thru						Thru		Left	Thru	
Leading Detector (ft)	20	100						100		20	100	
Trailing Detector (ft)	0	0						0		0	0	
Detector 1 Position(ft)	0	0						0		0	0	
Detector 1 Size(ft)	20	6						6		20	6	
Detector 1 Type	Cl+Ex	Cl+Ex						Cl+Ex		Cl+Ex	Cl+Ex	
Detector 1 Channel												
Detector 1 Extend (s)	0.0	0.0						0.0		0.0	0.0	
Detector 1 Queue (s)	0.0	0.0						0.0		0.0	0.0	
Detector 1 Delay (s)	0.0	0.0						0.0		0.0	0.0	
Detector 2 Position(ft)		94						94			94	
Detector 2 Size(ft)		6						6			6	
Detector 2 Type		Cl+Ex						Cl+Ex			Cl+Ex	
Detector 2 Channel												
Detector 2 Extend (s)		0.0						0.0			0.0	
Turn Type	Perm	NA						NA		pm+pt	NA	
Protected Phases		4						2		1	6	
Permitted Phases		4								6		

Lanes, Volumes, Timings
2: NE Main Street (SC 417) & Curtis Street

Build (2028) AM
Burdette North TIS

	↖		→		↘		↙		←		↖		↗		↑		↘		↓		↙	
Lane Group	EBL	EBT	EBR	WBL	WBT	WBR	NBL	NBT	NBR	SBL	SBT	SBR										
Detector Phase	4	4						2		1	6											
Switch Phase																						
Minimum Initial (s)	7.0	7.0						12.0		5.0	12.0											
Minimum Split (s)	22.5	22.5						22.5		9.5	22.5											
Total Split (s)	25.0	25.0						52.0		23.0	75.0											
Total Split (%)	25.0%	25.0%						52.0%		23.0%	75.0%											
Maximum Green (s)	20.5	20.5						47.5		18.5	70.5											
Yellow Time (s)	3.5	3.5						3.5		3.5	3.5											
All-Red Time (s)	1.0	1.0						1.0		1.0	1.0											
Lost Time Adjust (s)		0.0						0.0		0.0	0.0											
Total Lost Time (s)		4.5						4.5		4.5	4.5											
Lead/Lag								Lead		Lag												
Lead-Lag Optimize?								Yes		Yes												
Vehicle Extension (s)	3.0	3.0						3.0		3.0	3.0											
Recall Mode	None	None						C-Max		None	C-Max											
Walk Time (s)	7.0	7.0						7.0			7.0											
Flash Don't Walk (s)	11.0	11.0						11.0			11.0											
Pedestrian Calls (#/hr)	0	0						0			0											
Act Effct Green (s)		20.3						47.7		70.7	70.7											
Actuated g/C Ratio		0.20						0.48		0.71	0.71											
v/c Ratio		0.89						0.88		0.87	0.47											
Control Delay (s/veh)		54.9						36.3		26.1	1.5											
Queue Delay		0.0						0.0		4.2	0.5											
Total Delay (s/veh)		54.9						36.3		30.3	1.9											
LOS		D						D		C	A											
Approach Delay (s/veh)		54.9						36.3			13.0											
Approach LOS		D						D			B											

Intersection Summary

Area Type: Other
 Cycle Length: 100
 Actuated Cycle Length: 100
 Offset: 39 (39%), Referenced to phase 2:NBT and 6:SBTL, Start of Green
 Natural Cycle: 90
 Control Type: Actuated-Coordinated
 Maximum v/c Ratio: 0.89
 Intersection Signal Delay (s/veh): 31.4 Intersection LOS: C
 Intersection Capacity Utilization 85.2% ICU Level of Service E
 Analysis Period (min) 15

Splits and Phases: 2: NE Main Street (SC 417) & Curtis Street



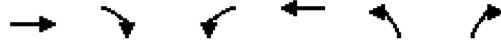

Lane Group	EBT	EBR	WBL	WBT	NBL	NBR
Lane Configurations				↕↕	↕	
Traffic Volume (vph)	0	0	150	584	30	0
Future Volume (vph)	0	0	150	584	30	0
Ideal Flow (vphp)	1900	1900	1900	1900	1900	1900
Lane Util. Factor	1.00	1.00	0.95	0.95	1.00	1.00
Fr						
Flt Protected				0.990	0.950	
Satd. Flow (prot)	0	0	0	3504	1770	0
Flt Permitted				0.990	0.950	
Satd. Flow (perm)	0	0	0	3504	1770	0
Link Speed (mph)	25			25	25	
Link Distance (ft)	100			1158	256	
Travel Time (s)	2.7			31.6	7.0	
Peak Hour Factor	0.90	0.90	0.90	0.90	0.90	0.90
Adj. Flow (vph)	0	0	167	649	33	0
Shared Lane Traffic (%)						
Lane Group Flow (vph)	0	0	0	816	33	0
Enter Blocked Intersection	No	No	No	No	No	No
Lane Alignment	Left	Right	Left	Left	Left	Right
Median Width(ft)	0			0	12	
Link Offset(ft)	0			0	0	
Crosswalk Width(ft)	16			16	16	
Two way Left Turn Lane						
Headway Factor	1.00	1.00	1.00	1.00	1.00	1.00
Turning Speed (mph)		9	15		15	9
Sign Control	Free			Free	Stop	

Intersection Summary	
Area Type:	Other
Control Type:	Unsignalized
Intersection Capacity Utilization	30.5%
Analysis Period (min)	15
	ICU Level of Service A

Intersection						
Int Delay, s/veh	0.6					
Movement	EBT	EBR	WBL	WBT	NBL	NBR
Lane Configurations				↑↑	↑	
Traffic Vol, veh/h	0	0	150	584	30	0
Future Vol, veh/h	0	0	150	584	30	0
Conflicting Peds, #/hr	0	0	0	0	0	0
Sign Control	Free	Free	Free	Free	Stop	Stop
RT Channelized	-	None	-	None	-	None
Storage Length	-	-	-	-	0	-
Veh in Median Storage, #	0	-	-	0	0	-
Grade, %	0	-	-	0	0	-
Peak Hour Factor	90	90	90	90	90	90
Heavy Vehicles, %	2	2	2	2	2	2
Mvmt Flow	0	0	167	649	33	0















Major/Minor	Major2	Minor1		
Conflicting Flow All	0	0	659	-
Stage 1	-	-	0	-
Stage 2	-	-	659	-
Critical Hdwy	4.14	-	6.84	-
Critical Hdwy Stg 1	-	-	-	-
Critical Hdwy Stg 2	-	-	5.84	-
Follow-up Hdwy	2.22	-	3.52	-
Pot Cap-1 Maneuver	-	-	397	0
Stage 1	-	-	-	0
Stage 2	-	-	476	0
Platoon blocked, %			-	
Mov Cap-1 Maneuver	-	-	397	-
Mov Cap-2 Maneuver	-	-	397	-
Stage 1	-	-	-	-
Stage 2	-	-	476	-

Approach	WB	NB
HCM Ctrl Dly, s/v		14.9
HCM LOS		B

Minor Lane/Major Mvmt	NBLn1	WBL	WBT
Capacity (veh/h)	397	-	-
HCM Lane V/C Ratio	0.084	-	-
HCM Ctrl Dly (s/v)	14.9	-	-
HCM Lane LOS	B	-	-
HCM 95th %tile Q (veh)	0.3	-	-

Lanes, Volumes, Timings
4: Hedge Street & Curtis Street

Build (2028) AM
Burdette North TIS

												
Lane Group	EBL	EBT	EBR	WBL	WBT	WBR	NBL	NBT	NBR	SBL	SBT	SBR
Lane Configurations												
Traffic Volume (vph)	67	926	153	0	0	0	0	36	281	130	16	0
Future Volume (vph)	67	926	153	0	0	0	0	36	281	130	16	0
Ideal Flow (vphpl)	1900	1900	1900	1900	1900	1900	1900	1900	1900	1900	1900	1900
Lane Util. Factor	0.95	0.95	0.95	1.00	1.00	1.00	1.00	1.00	1.00	1.00	1.00	1.00
Fr _t		0.980						0.880				
Fl _t Protected		0.997									0.957	
Satd. Flow (prot)	0	3458	0	0	0	0	0	1639	0	0	1783	0
Fl _t Permitted		0.997									0.957	
Satd. Flow (perm)	0	3458	0	0	0	0	0	1639	0	0	1783	0
Right Turn on Red			Yes			Yes			Yes			Yes
Satd. Flow (RTOR)		22						150				
Link Speed (mph)		25			25			25			25	
Link Distance (ft)		379			1213			1024			312	
Travel Time (s)		10.3			33.1			27.9			8.5	
Peak Hour Factor	0.90	0.90	0.90	0.90	0.90	0.90	0.90	0.90	0.90	0.90	0.90	0.90
Adj. Flow (vph)	74	1029	170	0	0	0	0	40	312	144	18	0
Shared Lane Traffic (%)												
Lane Group Flow (vph)	0	1273	0	0	0	0	0	352	0	0	162	0
Enter Blocked Intersection	No	No	No	No	No	No	No	No	No	No	No	No
Lane Alignment	Left	Left	Right	Left	Left	Right	Left	Left	Right	Left	Left	Right
Median Width(ft)		0			0			0			0	
Link Offset(ft)		0			0			0			0	
Crosswalk Width(ft)		16			16			16			16	
Two way Left Turn Lane												
Headway Factor	1.00	1.00	1.00	1.00	1.00	1.00	1.00	1.00	1.00	1.00	1.00	1.00
Turning Speed (mph)	15		9	15		9	15		9	15		9
Number of Detectors	1	2						1		1	1	
Detector Template	Left	Thru								Left		
Leading Detector (ft)	20	100						30		20	30	
Trailing Detector (ft)	0	0						0		0	0	
Detector 1 Position(ft)	0	0						0		0	0	
Detector 1 Size(ft)	20	6						30		20	30	
Detector 1 Type	Cl+Ex	Cl+Ex						Cl+Ex		Cl+Ex	Cl+Ex	
Detector 1 Channel												
Detector 1 Extend (s)	0.0	0.0						0.0		0.0	0.0	
Detector 1 Queue (s)	0.0	0.0						0.0		0.0	0.0	
Detector 1 Delay (s)	0.0	0.0						0.0		0.0	0.0	
Detector 2 Position(ft)		94										
Detector 2 Size(ft)		6										
Detector 2 Type		Cl+Ex										
Detector 2 Channel												
Detector 2 Extend (s)		0.0										
Turn Type	Perm	NA						NA		Split	NA	
Protected Phases		2						4		8	8	
Permitted Phases	2											
Detector Phase	2	2						4		8	8	
Switch Phase												
Minimum Initial (s)	7.0	7.0						7.0		7.0	7.0	

Lanes, Volumes, Timings
4: Hedge Street & Curtis Street

Build (2028) AM
Burdette North TIS

Lane Group	EBL	EBT	EBR	WBL	WBT	WBR	NBL	NBT	NBR	SBL	SBT	SBR
Minimum Split (s)	22.5	22.5						22.5		22.5	22.5	
Total Split (s)	49.2	49.2						28.0		22.8	22.8	
Total Split (%)	49.2%	49.2%						28.0%		22.8%	22.8%	
Maximum Green (s)	44.7	44.7						23.5		18.3	18.3	
Yellow Time (s)	3.5	3.5						3.5		3.5	3.5	
All-Red Time (s)	1.0	1.0						1.0		1.0	1.0	
Lost Time Adjust (s)		0.0						0.0			0.0	
Total Lost Time (s)		4.5						4.5			4.5	
Lead/Lag												
Lead-Lag Optimize?												
Vehicle Extension (s)	3.0	3.0						3.0		3.0	3.0	
Recall Mode	C-Max	C-Max						None		None	None	
Walk Time (s)	7.0	7.0						7.0		7.0	7.0	
Flash Don't Walk (s)	11.0	11.0						11.0		11.0	11.0	
Pedestrian Calls (#/hr)	0	0						0		0	0	
Act Effct Green (s)		54.7						17.8			14.0	
Actuated g/C Ratio		0.55						0.18			0.14	
v/c Ratio		0.67						0.85			0.65	
Control Delay (s/veh)		10.6						41.1			52.4	
Queue Delay		0.7						0.0			0.0	
Total Delay (s/veh)		11.2						41.1			52.4	
LOS		B						D			D	
Approach Delay (s/veh)		11.2						41.1			52.4	
Approach LOS		B						D			D	

Intersection Summary















Area Type:	Other
Cycle Length:	100
Actuated Cycle Length:	100
Offset:	0 (0%), Referenced to phase 2:EBTL, Start of Green
Natural Cycle:	80
Control Type:	Actuated-Coordinated
Maximum v/c Ratio:	0.85
Intersection Signal Delay (s/veh):	20.8
Intersection LOS:	C
Intersection Capacity Utilization:	71.0%
ICU Level of Service:	C
Analysis Period (min):	15

Splits and Phases: 4: Hedge Street & Curtis Street



Lanes, Volumes, Timings
5: Main Street & College Street

Build (2028) AM
Burdette North TIS

												
Lane Group	EBL	EBT	EBR	WBL	WBT	WBR	NBL	NBT	NBR	SBL	SBT	SBR
Lane Configurations												
Traffic Volume (vph)	0	0	0	59	457	4	45	3	0	0	15	30
Future Volume (vph)	0	0	0	59	457	4	45	3	0	0	15	30
Ideal Flow (vphpl)	1900	1900	1900	1900	1900	1900	1900	1900	1900	1900	1900	1900
Lane Util. Factor	1.00	1.00	1.00	0.95	0.95	0.95	1.00	1.00	1.00	1.00	1.00	1.00
Frt					0.999						0.911	
Flt Protected					0.994			0.955				
Satd. Flow (prot)	0	0	0	0	3514	0	0	1779	0	0	1697	0
Flt Permitted					0.994			0.955				
Satd. Flow (perm)	0	0	0	0	3514	0	0	1779	0	0	1697	0
Link Speed (mph)		25			25			25			25	
Link Distance (ft)		1082			82			565			1260	
Travel Time (s)		29.5			2.2			15.4			34.4	
Peak Hour Factor	0.90	0.90	0.90	0.90	0.90	0.90	0.90	0.90	0.90	0.90	0.90	0.90
Adj. Flow (vph)	0	0	0	66	508	4	50	3	0	0	17	33
Shared Lane Traffic (%)												
Lane Group Flow (vph)	0	0	0	0	578	0	0	53	0	0	50	0
Enter Blocked Intersection	No	No	No	No	No	No	No	No	No	No	No	No
Lane Alignment	Left	Left	Right	Left	Left	Right	Left	Left	Right	Left	Left	Right
Median Width(ft)		0			0			0			0	
Link Offset(ft)		0			0			0			0	
Crosswalk Width(ft)		16			16			16			16	
Two way Left Turn Lane												
Headway Factor	1.00	1.00	1.00	1.00	1.00	1.00	1.00	1.00	1.00	1.00	1.00	1.00
Turning Speed (mph)	15		9	15		9	15		9	15		9
Sign Control		Free			Free			Stop			Stop	
Intersection Summary												
Area Type:	Other											
Control Type:	Unsignalized											
Intersection Capacity Utilization	30.5%			ICU Level of Service A								
Analysis Period (min)	15											

Intersection												
Int Delay, s/veh	1.9											
Movement	EBL	EBT	EBR	WBL	WBT	WBR	NBL	NBT	NBR	SBL	SBT	SBR
Lane Configurations					↔			↔			↔	
Traffic Vol, veh/h	0	0	0	59	457	4	45	3	0	0	15	30
Future Vol, veh/h	0	0	0	59	457	4	45	3	0	0	15	30
Conflicting Peds, #/hr	0	0	0	0	0	0	0	0	0	0	0	0
Sign Control	Free	Free	Free	Free	Free	Free	Stop	Stop	Stop	Stop	Stop	Stop
RT Channelized	-	-	None	-	-	None	-	-	None	-	-	None
Storage Length	-	-	-	-	-	-	-	-	-	-	-	-
Veh in Median Storage, #	-	0	-	-	0	-	-	0	-	-	0	-
Grade, %	-	0	-	-	0	-	-	0	-	-	0	-
Peak Hour Factor	90	90	90	90	90	90	90	90	90	90	90	90
Heavy Vehicles, %	2	2	2	2	2	2	2	2	2	2	2	2
Mvmt Flow	0	0	0	66	508	4	50	3	0	0	17	33















Major/Minor	Major2	Minor1	Minor2
Conflicting Flow All	0	0	0
Stage 1	-	-	-
Stage 2	-	-	-
Critical Hdwy	4.14	-	-
Critical Hdwy Stg 1	-	-	-
Critical Hdwy Stg 2	-	-	-
Follow-up Hdwy	2.22	-	-
Pot Cap-1 Maneuver	-	-	-
Stage 1	-	-	-
Stage 2	-	-	-
Platoon blocked, %	-	-	-
Mov Cap-1 Maneuver	-	-	-
Mov Cap-2 Maneuver	-	-	-
Stage 1	-	-	-
Stage 2	-	-	-

Approach	WB	NB	SB
HCM Ctrl Dly, s/v		13.2	11.9
HCM LOS		B	B

Minor Lane/Major Mvmt	NBLn1	WBL	WBT	WBR	SBLn1
Capacity (veh/h)	490	-	-	-	572
HCM Lane V/C Ratio	0.109	-	-	-	0.087
HCM Ctrl Dly (s/v)	13.2	-	-	-	11.9
HCM Lane LOS	B	-	-	-	B
HCM 95th %tile Q (veh)	0.4	-	-	-	0.3

Lanes, Volumes, Timings
6: Main Street & Curtis Street

Build (2028) AM
Burdette North TIS

												
Lane Group	EBL	EBT	EBR	WBL	WBT	WBR	NBL	NBT	NBR	SBL	SBT	SBR
Lane Configurations												
Traffic Volume (vph)	7	516	4	0	0	0	0	3	31	27	31	0
Future Volume (vph)	7	516	4	0	0	0	0	3	31	27	31	0
Ideal Flow (vphpl)	1900	1900	1900	1900	1900	1900	1900	1900	1900	1900	1900	1900
Lane Util. Factor	0.95	0.95	0.95	1.00	1.00	1.00	1.00	1.00	1.00	1.00	1.00	1.00
Fr _t		0.999						0.876				
Fl _t Protected		0.999									0.977	
Satd. Flow (prot)	0	3532	0	0	0	0	0	1632	0	0	1820	0
Fl _t Permitted		0.999									0.977	
Satd. Flow (perm)	0	3532	0	0	0	0	0	1632	0	0	1820	0
Link Speed (mph)		25			25			25			25	
Link Distance (ft)		1197			85			1027			565	
Travel Time (s)		32.6			2.3			28.0			15.4	
Peak Hour Factor	0.90	0.90	0.90	0.90	0.90	0.90	0.90	0.90	0.90	0.90	0.90	0.90
Adj. Flow (vph)	8	573	4	0	0	0	0	3	34	30	34	0
Shared Lane Traffic (%)												
Lane Group Flow (vph)	0	585	0	0	0	0	0	37	0	0	64	0
Enter Blocked Intersection	No	No	No	No	No	No	No	No	No	No	No	No
Lane Alignment	Left	Left	Right	Left	Left	Right	Left	Left	Right	Left	Left	Right
Median Width(ft)		0			0			0			0	
Link Offset(ft)		0			0			0			0	
Crosswalk Width(ft)		16			16			16			16	
Two way Left Turn Lane												
Headway Factor	1.00	1.00	1.00	1.00	1.00	1.00	1.00	1.00	1.00	1.00	1.00	1.00
Turning Speed (mph)	15		9	15		9	15		9	15		9
Sign Control		Free			Free			Stop			Stop	
Intersection Summary												
Area Type:	Other											
Control Type:	Unsignalized											
Intersection Capacity Utilization	31.1%						ICU Level of Service A					
Analysis Period (min)	15											

Intersection												
Int Delay, s/veh	1.9											
Movement	EBL	EBT	EBR	WBL	WBT	WBR	NBL	NBT	NBR	SBL	SBT	SBR
Lane Configurations		↔↔						↔			↔	
Traffic Vol, veh/h	7	516	4	0	0	0	0	3	31	27	31	0
Future Vol, veh/h	7	516	4	0	0	0	0	3	31	27	31	0
Conflicting Peds, #/hr	0	0	0	0	0	0	0	0	0	0	0	0
Sign Control	Free	Free	Free	Free	Free	Free	Stop	Stop	Stop	Stop	Stop	Stop
RT Channelized	-	-	None	-	-	None	-	-	None	-	-	None
Storage Length	-	-	-	-	-	-	-	-	-	-	-	-
Veh in Median Storage, #	-	0	-	-	0	-	-	0	-	-	0	-
Grade, %	-	0	-	-	0	-	-	0	-	-	0	-
Peak Hour Factor	90	90	90	90	90	90	90	90	90	90	90	90
Heavy Vehicles, %	2	2	2	2	2	2	2	2	2	2	2	2
Mvmt Flow	8	573	4	0	0	0	0	3	34	30	34	0

Major/Minor	Major1			Minor1			Minor2		
Conflicting Flow All	0	0	0	-	591	289	304	593	-
Stage 1	-	-	-	-	591	-	0	0	-
Stage 2	-	-	-	-	0	-	304	593	-
Critical Hdwy	4.14	-	-	-	6.54	6.94	7.54	6.54	-
Critical Hdwy Stg 1	-	-	-	-	5.54	-	-	-	-
Critical Hdwy Stg 2	-	-	-	-	-	-	6.54	5.54	-
Follow-up Hdwy	2.22	-	-	-	4.02	3.32	3.52	4.02	-
Pot Cap-1 Maneuver	-	-	-	0	418	708	625	417	0
Stage 1	-	-	-	0	493	-	-	-	0
Stage 2	-	-	-	0	-	-	681	492	0
Platoon blocked, %	-	-	-	-	-	-	-	-	-
Mov Cap-1 Maneuver	-	-	-	-	418	708	591	417	-
Mov Cap-2 Maneuver	-	-	-	-	418	-	591	417	-
Stage 1	-	-	-	-	493	-	-	-	-
Stage 2	-	-	-	-	-	-	643	492	-

Approach	EB	NB	SB
HCM Ctrl Dly, s/v		10.7	13.6
HCM LOS		B	B

Minor Lane/Major Mvmt	NBLn1	EBL	EBT	EBR	SBLn1
Capacity (veh/h)	667	-	-	-	483
HCM Lane V/C Ratio	0.057	-	-	-	0.133
HCM Ctrl Dly (s/v)	10.7	-	-	-	13.6
HCM Lane LOS	B	-	-	-	B
HCM 95th %tile Q (veh)	0.2	-	-	-	0.5



Lane Group	EBL	EBR	NBL	NBT	SBT	SBR
Lane Configurations						
Traffic Volume (vph)	9	22	57	46	138	12
Future Volume (vph)	9	22	57	46	138	12
Ideal Flow (vphp)	1900	1900	1900	1900	1900	1900
Lane Util. Factor	1.00	1.00	1.00	1.00	1.00	1.00
Frt	0.905			0.989		
Flt Protected	0.986			0.973		
Satd. Flow (prot)	1662	0	0	1812	1842	0
Flt Permitted	0.986			0.973		
Satd. Flow (perm)	1662	0	0	1812	1842	0
Link Speed (mph)	25			25	25	
Link Distance (ft)	1169			312	256	
Travel Time (s)	31.9			8.5	7.0	
Peak Hour Factor	0.90	0.90	0.90	0.90	0.90	0.90
Adj. Flow (vph)	10	24	63	51	153	13
Shared Lane Traffic (%)						
Lane Group Flow (vph)	34	0	0	114	166	0
Enter Blocked Intersection	No	No	No	No	No	No
Lane Alignment	Left	Right	Left	Left	Left	Right
Median Width(ft)	12			0	0	
Link Offset(ft)	0			0	0	
Crosswalk Width(ft)	16			16	16	
Two way Left Turn Lane						
Headway Factor	1.00	1.00	1.00	1.00	1.00	1.00
Turning Speed (mph)	15	9	15			9
Sign Control	Stop			Free	Free	

Intersection Summary

Area Type:	Other
Control Type:	Unsignalized
Intersection Capacity Utilization	26.9%
Analysis Period (min)	15
	ICU Level of Service A

Intersection						
Int Delay, s/veh	2.6					
Movement	EBL	EBR	NBL	NBT	SBT	SBR
Lane Configurations	T		T		T	
Traffic Vol, veh/h	9	22	57	46	138	12
Future Vol, veh/h	9	22	57	46	138	12
Conflicting Peds, #/hr	0	0	0	0	0	0
Sign Control	Stop	Stop	Free	Free	Free	Free
RT Channelized	-	None	-	None	-	None
Storage Length	0	-	-	-	-	-
Veh in Median Storage, #	0	-	-	0	0	-
Grade, %	0	-	-	0	0	-
Peak Hour Factor	90	90	90	90	90	90
Heavy Vehicles, %	2	2	2	2	2	2
Mvmt Flow	10	24	63	51	153	13

Major/Minor	Minor2	Major1	Major2			
Conflicting Flow All	337	160	166	0	-	0
Stage 1	160	-	-	-	-	-
Stage 2	177	-	-	-	-	-
Critical Hdwy	6.42	6.22	4.12	-	-	-
Critical Hdwy Stg 1	5.42	-	-	-	-	-
Critical Hdwy Stg 2	5.42	-	-	-	-	-
Follow-up Hdwy	3.518	3.318	2.218	-	-	-
Pot Cap-1 Maneuver	658	885	1412	-	-	-
Stage 1	869	-	-	-	-	-
Stage 2	854	-	-	-	-	-
Platoon blocked, %				-	-	-
Mov Cap-1 Maneuver	628	885	1412	-	-	-
Mov Cap-2 Maneuver	628	-	-	-	-	-
Stage 1	829	-	-	-	-	-
Stage 2	854	-	-	-	-	-

Approach	EB	NB	SB
HCM Ctrl Dly, s/v	9.8	4.2	0
HCM LOS	A		

Minor Lane/Major Mvmt	NBL	NBT	EBLn1	SBT	SBR
Capacity (veh/h)	1412	-	791	-	-
HCM Lane V/C Ratio	0.045	-	0.044	-	-
HCM Ctrl Dly (s/v)	7.7	0	9.8	-	-
HCM Lane LOS	A	A	A	-	-
HCM 95th %tile Q (veh)	0.1	-	0.1	-	-

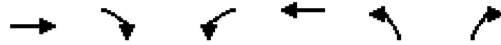

Lane Group	EBT	EBR	WBL	WBT	NBL	NBR
Lane Configurations				↔↔	↔	
Traffic Volume (vph)	0	0	8	606	31	0
Future Volume (vph)	0	0	8	606	31	0
Ideal Flow (vphp)	1900	1900	1900	1900	1900	1900
Lane Util. Factor	1.00	1.00	0.95	0.95	1.00	1.00
Frnt						
Flt Protected				0.999	0.950	
Satd. Flow (prot)	0	0	0	3536	1770	0
Flt Permitted				0.999	0.950	
Satd. Flow (perm)	0	0	0	3536	1770	0
Link Speed (mph)	25			25	25	
Link Distance (ft)	313			100	1023	
Travel Time (s)	8.5			2.7	27.9	
Peak Hour Factor	0.90	0.90	0.90	0.90	0.90	0.90
Adj. Flow (vph)	0	0	9	673	34	0
Shared Lane Traffic (%)						
Lane Group Flow (vph)	0	0	0	682	34	0
Enter Blocked Intersection	No	No	No	No	No	No
Lane Alignment	Left	Right	Left	Left	Left	Right
Median Width(ft)	0			0	12	
Link Offset(ft)	0			0	0	
Crosswalk Width(ft)	16			16	16	
Two way Left Turn Lane						
Headway Factor	1.00	1.00	1.00	1.00	1.00	1.00
Turning Speed (mph)		9	15		15	9
Sign Control	Free			Free	Stop	

Intersection Summary

Area Type:	Other
Control Type:	Unsignalized
Intersection Capacity Utilization	27.0%
Analysis Period (min)	15
	ICU Level of Service A

Intersection						
Int Delay, s/veh	0.5					
Movement	EBT	EBR	WBL	WBT	NBL	NBR
Lane Configurations				↑↑	↑	
Traffic Vol, veh/h	0	0	8	606	31	0
Future Vol, veh/h	0	0	8	606	31	0
Conflicting Peds, #/hr	0	0	0	0	0	0
Sign Control	Free	Free	Free	Free	Stop	Stop
RT Channelized	-	None	-	None	-	None
Storage Length	-	-	-	-	0	-
Veh in Median Storage, #	0	-	-	0	0	-
Grade, %	0	-	-	0	0	-
Peak Hour Factor	90	90	90	90	90	90
Heavy Vehicles, %	2	2	2	2	2	2
Mvmt Flow	0	0	9	673	34	0

Major/Minor	Major2	Minor1		
Conflicting Flow All	0	0	355	-
Stage 1	-	-	0	-
Stage 2	-	-	355	-
Critical Hdwy	4.14	-	6.84	-
Critical Hdwy Stg 1	-	-	-	-
Critical Hdwy Stg 2	-	-	5.84	-
Follow-up Hdwy	2.22	-	3.52	-
Pot Cap-1 Maneuver	-	-	617	0
Stage 1	-	-	-	0
Stage 2	-	-	681	0
Platoon blocked, %			-	
Mov Cap-1 Maneuver	-	-	617	-
Mov Cap-2 Maneuver	-	-	617	-
Stage 1	-	-	-	-
Stage 2	-	-	681	-

Approach	WB	NB
HCM Ctrl Dly, s/v		11.2
HCM LOS		B

Minor Lane/Major Mvmt	NBLn1	WBL	WBT
Capacity (veh/h)	617	-	-
HCM Lane V/C Ratio	0.056	-	-
HCM Ctrl Dly (s/v)	11.2	-	-
HCM Lane LOS	B	-	-
HCM 95th %tile Q (veh)	0.2	-	-

APPENDIX D

SIMTRAFFIC ANALYSIS REPORTS

Intersection: 1: NE Main Street (SC 417) & College Street

Movement	EB	WB	NB	NB	SB	SB
Directions Served	LTR	LTR	L	TR	L	TR
Maximum Queue (ft)	61	360	31	317	150	329
Average Queue (ft)	31	312	3	132	36	165
95th Queue (ft)	45	419	16	258	91	283
Link Distance (ft)	16	341		507		1225
Upstream Blk Time (%)	48	26				
Queuing Penalty (veh)	83	120				
Storage Bay Dist (ft)			125		125	
Storage Blk Time (%)				10		14
Queuing Penalty (veh)				1		8

Intersection: 2: NE Main Street (SC 417) & Curtis Street

Movement	EB	WB	NB	NB	SB	SB
Directions Served	LTR	LTR	L	TR	L	TR
Maximum Queue (ft)	62	334	67	327	115	175
Average Queue (ft)	31	282	15	158	46	64
95th Queue (ft)	45	392	55	279	90	134
Link Distance (ft)	13	309		1047		507
Upstream Blk Time (%)	54	13				
Queuing Penalty (veh)	124	53				
Storage Bay Dist (ft)			150		150	
Storage Blk Time (%)				9	0	1
Queuing Penalty (veh)				2	0	1

Intersection: 3: Hedge Street & College Street

Movement	EB	WB	NB
Directions Served	TR	LT	LR
Maximum Queue (ft)	15	555	292
Average Queue (ft)	1	245	140
95th Queue (ft)	9	681	412
Link Distance (ft)	341	1137	508
Upstream Blk Time (%)		2	4
Queuing Penalty (veh)		0	3
Storage Bay Dist (ft)			
Storage Blk Time (%)			
Queuing Penalty (veh)			

Intersection: 4: Hedge Street & Curtis Street

Movement	EB	WB	NB	SB
Directions Served	LTR	LTR	LTR	LTR
Maximum Queue (ft)	194	872	352	225
Average Queue (ft)	89	421	139	114
95th Queue (ft)	167	1018	308	198
Link Distance (ft)	309	1185	990	508
Upstream Blk Time (%)	1	6		
Queuing Penalty (veh)	2	0		
Storage Bay Dist (ft)				
Storage Blk Time (%)				
Queuing Penalty (veh)				

Intersection: 5: Main Street & College Street

Movement	EB	WB	NB	SB
Directions Served	LTR	LTR	LTR	LTR
Maximum Queue (ft)	209	26	36	57
Average Queue (ft)	83	2	8	18
95th Queue (ft)	177	13	29	65
Link Distance (ft)	1053	16	506	1230
Upstream Blk Time (%)		0		
Queuing Penalty (veh)		0		
Storage Bay Dist (ft)				
Storage Blk Time (%)				
Queuing Penalty (veh)				

Intersection: 6: Main Street & Curtis Street

Movement	EB	WB	NB	SB
Directions Served	LTR	LTR	LTR	LTR
Maximum Queue (ft)	326	30	138	81
Average Queue (ft)	138	2	44	21
95th Queue (ft)	296	15	135	85
Link Distance (ft)	1159	13	988	506
Upstream Blk Time (%)		0		
Queuing Penalty (veh)		0		
Storage Bay Dist (ft)				
Storage Blk Time (%)				
Queuing Penalty (veh)				

Network Summary

Network wide Queuing Penalty: 398

Intersection: 1: NE Main Street (SC 417) & College Street

Movement	EB	WB	NB	NB	SB	SB
Directions Served	LTR	LTR	L	TR	L	TR
Maximum Queue (ft)	67	355	43	208	224	783
Average Queue (ft)	32	238	7	85	59	265
95th Queue (ft)	48	382	29	165	146	766
Link Distance (ft)	16	341		507		1225
Upstream Blk Time (%)	70	13				8
Queuing Penalty (veh)	166	36				0
Storage Bay Dist (ft)			125		125	
Storage Blk Time (%)				3	0	21
Queuing Penalty (veh)				0	2	25

Intersection: 2: NE Main Street (SC 417) & Curtis Street

Movement	EB	WB	NB	NB	SB	SB
Directions Served	LTR	LTR	L	TR	L	TR
Maximum Queue (ft)	46	334	154	375	184	202
Average Queue (ft)	30	299	30	183	75	81
95th Queue (ft)	39	381	109	321	150	167
Link Distance (ft)	13	309		1047		507
Upstream Blk Time (%)	72	39				
Queuing Penalty (veh)	207	111				
Storage Bay Dist (ft)			150		150	
Storage Blk Time (%)				12	1	1
Queuing Penalty (veh)				5	7	2

Intersection: 3: Hedge Street & College Street

Movement	EB	WB	NB
Directions Served	TR	LT	LR
Maximum Queue (ft)	15	529	139
Average Queue (ft)	1	93	35
95th Queue (ft)	7	476	91
Link Distance (ft)	341	1137	508
Upstream Blk Time (%)		3	
Queuing Penalty (veh)		0	
Storage Bay Dist (ft)			
Storage Blk Time (%)			
Queuing Penalty (veh)			

Intersection: 4: Hedge Street & Curtis Street

Movement	EB	WB	NB	SB
Directions Served	LTR	LTR	LTR	LTR
Maximum Queue (ft)	272	810	440	258
Average Queue (ft)	130	423	183	117
95th Queue (ft)	232	903	418	214
Link Distance (ft)	309	1185	990	508
Upstream Blk Time (%)	0	2		
Queuing Penalty (veh)	0	0		
Storage Bay Dist (ft)				
Storage Blk Time (%)				
Queuing Penalty (veh)				

Intersection: 5: Main Street & College Street

Movement	EB	WB	NB	SB
Directions Served	LTR	LTR	LTR	LTR
Maximum Queue (ft)	792	31	161	783
Average Queue (ft)	512	5	67	423
95th Queue (ft)	961	21	175	835
Link Distance (ft)	1053	16	506	1230
Upstream Blk Time (%)	5	11		
Queuing Penalty (veh)	0	22		
Storage Bay Dist (ft)				
Storage Blk Time (%)				
Queuing Penalty (veh)				

Intersection: 6: Main Street & Curtis Street

Movement	EB	WB	NB	SB
Directions Served	LTR	LTR	LTR	LTR
Maximum Queue (ft)	1193	30	694	488
Average Queue (ft)	949	4	358	332
95th Queue (ft)	1424	21	702	554
Link Distance (ft)	1159	13	988	506
Upstream Blk Time (%)	44	0	0	13
Queuing Penalty (veh)	0	1	0	2
Storage Bay Dist (ft)				
Storage Blk Time (%)				
Queuing Penalty (veh)				

Network Summary

Network wide Queuing Penalty: 587

Intersection: 1: NE Main Street (SC 417) & College Street

Movement	WB	WB	NB	NB	SB
Directions Served	LT	TR	L	T	TR
Maximum Queue (ft)	372	380	67	219	390
Average Queue (ft)	335	343	20	83	212
95th Queue (ft)	412	406	53	175	336
Link Distance (ft)	342	342		532	1213
Upstream Blk Time (%)	37	43			
Queuing Penalty (veh)	167	194			
Storage Bay Dist (ft)			150		
Storage Blk Time (%)				1	
Queuing Penalty (veh)				0	

Intersection: 2: NE Main Street (SC 417) & Curtis Street

Movement	EB	EB	NB	SB	SB
Directions Served	LT	TR	TR	L	T
Maximum Queue (ft)	38	46	259	123	99
Average Queue (ft)	24	29	89	48	29
95th Queue (ft)	31	38	192	91	77
Link Distance (ft)	10	10	1035		532
Upstream Blk Time (%)	82	81			
Queuing Penalty (veh)	174	172			
Storage Bay Dist (ft)				225	
Storage Blk Time (%)					
Queuing Penalty (veh)					

Intersection: 3: Hedge Street & College Street

Movement	WB	WB	NB
Directions Served	LT	T	L
Maximum Queue (ft)	854	834	167
Average Queue (ft)	447	440	51
95th Queue (ft)	1042	1022	172
Link Distance (ft)	1136	1136	531
Upstream Blk Time (%)	8	9	
Queuing Penalty (veh)	0	0	
Storage Bay Dist (ft)			
Storage Blk Time (%)			
Queuing Penalty (veh)			

Intersection: 4: Hedge Street & Curtis Street

Movement	EB	EB	NB	SB
Directions Served	LT	TR	TR	LT
Maximum Queue (ft)	100	105	216	322
Average Queue (ft)	34	42	88	144
95th Queue (ft)	75	88	171	265
Link Distance (ft)	307	307	978	531
Upstream Blk Time (%)				
Queuing Penalty (veh)				
Storage Bay Dist (ft)				
Storage Blk Time (%)				
Queuing Penalty (veh)				

Intersection: 5: Main Street & College Street

Movement	WB	WB	NB	SB
Directions Served	LT	TR	LT	TR
Maximum Queue (ft)	7	8	56	40
Average Queue (ft)	0	0	21	17
95th Queue (ft)	5	5	49	44
Link Distance (ft)	17	17	530	1219
Upstream Blk Time (%)		0		
Queuing Penalty (veh)		0		
Storage Bay Dist (ft)				
Storage Blk Time (%)				
Queuing Penalty (veh)				

Intersection: 6: Main Street & Curtis Street

Movement	EB	EB	NB	SB
Directions Served	LT	TR	TR	LT
Maximum Queue (ft)	1186	1190	658	205
Average Queue (ft)	947	936	338	86
95th Queue (ft)	1423	1424	661	255
Link Distance (ft)	1155	1155	976	530
Upstream Blk Time (%)	50	49		
Queuing Penalty (veh)	0	0		
Storage Bay Dist (ft)				
Storage Blk Time (%)				
Queuing Penalty (veh)				

Network Summary

Network wide Queuing Penalty: 709

Intersection: 1: NE Main Street (SC 417) & College Street

Movement	WB	WB	NB	NB	SB
Directions Served	LT	TR	L	T	TR
Maximum Queue (ft)	364	370	223	480	1245
Average Queue (ft)	334	256	116	200	782
95th Queue (ft)	407	489	267	545	1573
Link Distance (ft)	342	342		532	1213
Upstream Blk Time (%)	74	39		21	47
Queuing Penalty (veh)	222	115		106	0
Storage Bay Dist (ft)			150		
Storage Blk Time (%)			40	5	
Queuing Penalty (veh)			201	3	

Intersection: 2: NE Main Street (SC 417) & Curtis Street

Movement	EB	EB	NB	SB	SB
Directions Served	LT	TR	TR	L	T
Maximum Queue (ft)	32	53	906	229	118
Average Queue (ft)	22	29	403	59	20
95th Queue (ft)	31	39	1060	171	76
Link Distance (ft)	10	10	1035		532
Upstream Blk Time (%)	84	79	22		
Queuing Penalty (veh)	235	222	0		
Storage Bay Dist (ft)				225	
Storage Blk Time (%)				0	0
Queuing Penalty (veh)				2	0

Intersection: 3: Hedge Street & College Street

Movement	WB	WB	NB
Directions Served	LT	T	L
Maximum Queue (ft)	1158	1164	183
Average Queue (ft)	765	757	58
95th Queue (ft)	1539	1540	167
Link Distance (ft)	1136	1136	531
Upstream Blk Time (%)	53	52	
Queuing Penalty (veh)	0	0	
Storage Bay Dist (ft)			
Storage Blk Time (%)			
Queuing Penalty (veh)			

Intersection: 4: Hedge Street & Curtis Street

Movement	EB	EB	NB	SB
Directions Served	LT	TR	TR	LT
Maximum Queue (ft)	153	156	293	173
Average Queue (ft)	42	53	118	44
95th Queue (ft)	114	132	216	133
Link Distance (ft)	307	307	978	531
Upstream Blk Time (%)				
Queuing Penalty (veh)				
Storage Bay Dist (ft)				
Storage Blk Time (%)				
Queuing Penalty (veh)				

Intersection: 5: Main Street & College Street

Movement	WB	WB	NB	SB
Directions Served	LT	TR	LT	TR
Maximum Queue (ft)	34	9	53	507
Average Queue (ft)	14	0	23	190
95th Queue (ft)	33	5	49	550
Link Distance (ft)	17	17	530	1219
Upstream Blk Time (%)	61	0		
Queuing Penalty (veh)	156	0		
Storage Bay Dist (ft)				
Storage Blk Time (%)				
Queuing Penalty (veh)				

Intersection: 6: Main Street & Curtis Street

Movement	EB	EB	NB	SB
Directions Served	LT	TR	TR	LT
Maximum Queue (ft)	1193	1195	778	536
Average Queue (ft)	1090	1083	476	462
95th Queue (ft)	1381	1386	821	665
Link Distance (ft)	1155	1155	976	530
Upstream Blk Time (%)	76	75	0	65
Queuing Penalty (veh)	0	0	0	48
Storage Bay Dist (ft)				
Storage Blk Time (%)				
Queuing Penalty (veh)				

Network Summary

Network wide Queuing Penalty: 1310

Intersection: 1: NE Main Street (SC 417) & College Street

Movement	WB	WB	NB	NB	SB
Directions Served	LT	TR	L	T	TR
Maximum Queue (ft)	265	269	93	213	383
Average Queue (ft)	225	230	22	75	201
95th Queue (ft)	331	339	62	167	361
Link Distance (ft)	244	244		532	1213
Upstream Blk Time (%)	32	39			
Queuing Penalty (veh)	153	183			
Storage Bay Dist (ft)			150		
Storage Blk Time (%)				1	
Queuing Penalty (veh)				0	

Intersection: 2: NE Main Street (SC 417) & Curtis Street

Movement	EB	EB	NB	SB	SB
Directions Served	LT	TR	TR	L	T
Maximum Queue (ft)	38	47	235	103	102
Average Queue (ft)	24	29	80	44	28
95th Queue (ft)	33	37	171	81	79
Link Distance (ft)	10	10	1035		532
Upstream Blk Time (%)	83	82			
Queuing Penalty (veh)	178	176			
Storage Bay Dist (ft)				225	
Storage Blk Time (%)					
Queuing Penalty (veh)					

Intersection: 3: Hedge Street & College Street

Movement	WB	WB	NB
Directions Served	LT	T	L
Maximum Queue (ft)	1127	1122	197
Average Queue (ft)	800	797	121
95th Queue (ft)	1479	1468	249
Link Distance (ft)	1136	1136	203
Upstream Blk Time (%)	41	42	37
Queuing Penalty (veh)	0	0	15
Storage Bay Dist (ft)			
Storage Blk Time (%)			
Queuing Penalty (veh)			

Intersection: 4: Hedge Street & Curtis Street

Movement	EB	EB	NB	SB
Directions Served	LT	TR	TR	LT
Maximum Queue (ft)	112	121	513	260
Average Queue (ft)	38	45	156	123
95th Queue (ft)	95	98	501	234
Link Distance (ft)	307	307	978	273
Upstream Blk Time (%)			3	1
Queuing Penalty (veh)			0	1
Storage Bay Dist (ft)				
Storage Blk Time (%)				
Queuing Penalty (veh)				

Intersection: 5: Main Street & College Street

Movement	WB	WB	NB	SB
Directions Served	LT	TR	LT	TR
Maximum Queue (ft)	9	3	61	43
Average Queue (ft)	0	0	18	17
95th Queue (ft)	5	0	47	44
Link Distance (ft)	17	17	530	1219
Upstream Blk Time (%)	0	0		
Queuing Penalty (veh)	0	0		
Storage Bay Dist (ft)				
Storage Blk Time (%)				
Queuing Penalty (veh)				

Intersection: 6: Main Street & Curtis Street

Movement	EB	EB	NB	SB
Directions Served	LT	TR	TR	LT
Maximum Queue (ft)	1185	1195	722	140
Average Queue (ft)	1009	998	388	55
95th Queue (ft)	1433	1434	733	189
Link Distance (ft)	1155	1155	976	530
Upstream Blk Time (%)	59	58	0	
Queuing Penalty (veh)	0	0	0	
Storage Bay Dist (ft)				
Storage Blk Time (%)				
Queuing Penalty (veh)				

Intersection: 11: Hedge Street & Access A

Movement	EB	NB	SB
Directions Served	LR	LT	TR
Maximum Queue (ft)	160	188	26
Average Queue (ft)	44	71	1
95th Queue (ft)	148	238	23
Link Distance (ft)	1140	273	203
Upstream Blk Time (%)		13	0
Queuing Penalty (veh)		7	0
Storage Bay Dist (ft)			
Storage Blk Time (%)			
Queuing Penalty (veh)			

Intersection: 18: Access B & College Street

Movement	WB	WB	NB
Directions Served	LT	T	L
Maximum Queue (ft)	60	69	98
Average Queue (ft)	42	48	30
95th Queue (ft)	77	75	88
Link Distance (ft)	41	41	1004
Upstream Blk Time (%)	28	37	
Queuing Penalty (veh)	131	172	
Storage Bay Dist (ft)			
Storage Blk Time (%)			
Queuing Penalty (veh)			

Network Summary

Network wide Queuing Penalty: 1015

Intersection: 1: NE Main Street (SC 417) & College Street

Movement	WB	WB	NB	NB	SB
Directions Served	LT	TR	L	T	TR
Maximum Queue (ft)	253	273	223	538	1235
Average Queue (ft)	245	171	121	239	886
95th Queue (ft)	252	358	272	618	1594
Link Distance (ft)	243	243		532	1213
Upstream Blk Time (%)	86	42		33	57
Queuing Penalty (veh)	274	135		167	0
Storage Bay Dist (ft)			150		
Storage Blk Time (%)			44	9	
Queuing Penalty (veh)			221	5	

Intersection: 2: NE Main Street (SC 417) & Curtis Street

Movement	EB	EB	NB	SB	SB
Directions Served	LT	TR	TR	L	T
Maximum Queue (ft)	33	42	1050	237	161
Average Queue (ft)	21	25	439	50	16
95th Queue (ft)	32	43	1121	165	91
Link Distance (ft)	10	10	1035		532
Upstream Blk Time (%)	88	68	28		0
Queuing Penalty (veh)	251	194	0		0
Storage Bay Dist (ft)				225	
Storage Blk Time (%)				0	0
Queuing Penalty (veh)				2	1

Intersection: 3: Hedge Street & College Street

Movement	WB	WB	NB
Directions Served	LT	T	L
Maximum Queue (ft)	1160	1159	198
Average Queue (ft)	812	797	102
95th Queue (ft)	1499	1507	226
Link Distance (ft)	1136	1136	203
Upstream Blk Time (%)	56	55	25
Queuing Penalty (veh)	0	0	14
Storage Bay Dist (ft)			
Storage Blk Time (%)			
Queuing Penalty (veh)			

Intersection: 4: Hedge Street & Curtis Street

Movement	EB	EB	NB	SB
Directions Served	LT	TR	TR	LT
Maximum Queue (ft)	177	186	365	185
Average Queue (ft)	52	60	153	48
95th Queue (ft)	137	153	377	131
Link Distance (ft)	307	307	978	273
Upstream Blk Time (%)			2	0
Queuing Penalty (veh)			0	0
Storage Bay Dist (ft)				
Storage Blk Time (%)				
Queuing Penalty (veh)				

Intersection: 5: Main Street & College Street

Movement	WB	WB	NB	SB
Directions Served	LT	TR	LT	TR
Maximum Queue (ft)	36	3	60	613
Average Queue (ft)	16	0	23	231
95th Queue (ft)	37	3	50	620
Link Distance (ft)	17	17	530	1219
Upstream Blk Time (%)	68	0		
Queuing Penalty (veh)	177	0		
Storage Bay Dist (ft)				
Storage Blk Time (%)				
Queuing Penalty (veh)				

Intersection: 6: Main Street & Curtis Street

Movement	EB	EB	NB	SB
Directions Served	LT	TR	TR	LT
Maximum Queue (ft)	1186	1188	790	538
Average Queue (ft)	1107	1101	465	472
95th Queue (ft)	1345	1351	837	655
Link Distance (ft)	1155	1155	976	530
Upstream Blk Time (%)	80	78		71
Queuing Penalty (veh)	0	0		52
Storage Bay Dist (ft)				
Storage Blk Time (%)				
Queuing Penalty (veh)				

Intersection: 11: Hedge Street & Access A

Movement	EB	NB
Directions Served	LR	LT
Maximum Queue (ft)	91	179
Average Queue (ft)	26	36
95th Queue (ft)	75	159
Link Distance (ft)	1140	273
Upstream Blk Time (%)		4
Queuing Penalty (veh)		4
Storage Bay Dist (ft)		
Storage Blk Time (%)		
Queuing Penalty (veh)		

Intersection: 18: Access B & College Street

Movement	WB	WB	NB
Directions Served	LT	T	L
Maximum Queue (ft)	60	66	506
Average Queue (ft)	47	33	214
95th Queue (ft)	59	76	516
Link Distance (ft)	42	42	1003
Upstream Blk Time (%)	85	42	
Queuing Penalty (veh)	260	128	
Storage Bay Dist (ft)			
Storage Blk Time (%)			
Queuing Penalty (veh)			

Network Summary

Network wide Queuing Penalty: 1886

APPENDIX E

BACKGROUND IMPROVEMENTS

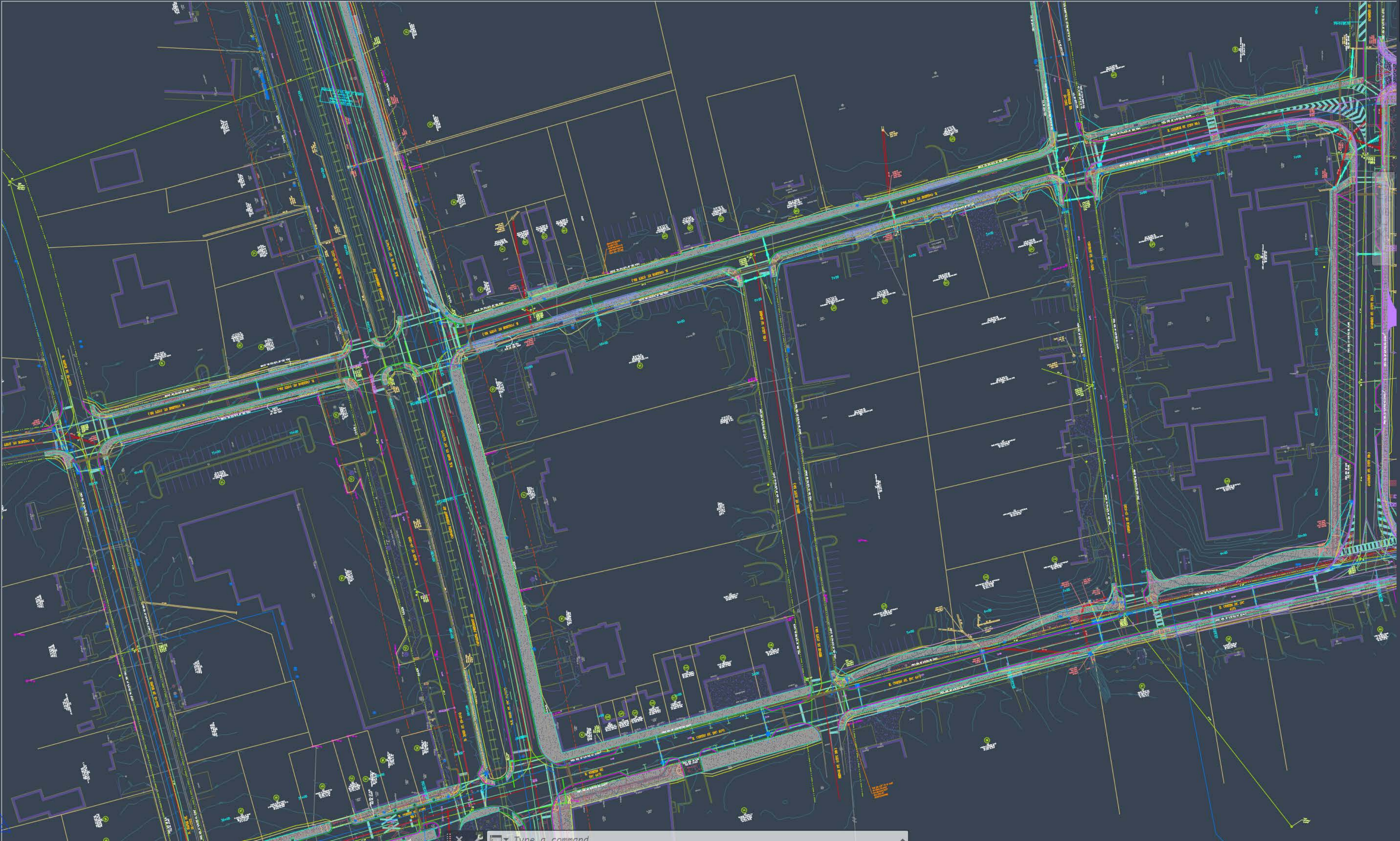

Type a command

**DEVELOPMENT AGREEMENT FOR BURDETTE NORTH DISTRICT
REDEVELOPMENT PROJECT**

THIS DEVELOPMENT AGREEMENT FOR BURDETTE NORTH DISTRICT REDEVELOPMENT PROJECT (the "Agreement") is effective _____, 2025 ("Effective Date"), between **CITY OF SIMPSONVILLE, SOUTH CAROLINA**, a body corporate and politic (the "City") of the State of South Carolina, and **BLUE RIDGE LAND HOLDINGS, LLC**, a South Carolina limited liability company ("Developer"). City and Developer are each a "Party," and collectively, the "Parties."

RECITALS:

WHEREAS, the Parties entered into a Purchase and Sale Agreement effective as of August 20, 2021, as amended by (i) Amendment to Purchase and Sale Agreement dated April 25, 2023, (ii) Second Amendment to Purchase and Sale Agreement dated November 21, 2024, (iii) Third Amendment to Purchase and Sale Agreement dated December 31, 2024, and (iv) Fourth Amendment to Purchase and Sale Agreement dated April 22, 2025 (the "PSA") whereby the Developer will purchase certain property from the City identified on Exhibit A attached hereto and made a part hereof (the "City Property") from the City; and,

WHEREAS, Developer is the owner of that certain property adjacent to the City Property being more particularly described on Exhibit B attached hereto and made a part hereof (the "Former Bank Property", and together with the City Property, the "Developer Property"); and,

WHEREAS, the Parties intend to cooperate to redevelop parcels of land more particularly described herein in the City of Simpsonville to create a privately-owned mixed-use development as set forth below; and,

WHEREAS, the Parties intend for the Burdette North District Redevelopment (defined in Section 5A below) to (i) create capital investment and full-time employment in the City's municipal limits, (ii) maximize public benefit and minimize public investment, (iii) provide business-urban district housing, provide for additional public benefit, (iv) respect existing City fabric such as height limits, historic buildings, design aesthetics, etc., and (v) provide for establishment of integrated site plans, urban design elements, land uses, architecture, site engineering, and landscape architecture, all while respecting the Simpsonville Comprehensive Plan: 2040 as it relates to land use; and,

WHEREAS, in exchange for providing these benefits to the City, Developer desires to receive the assurance that it may proceed with the development of the Developer Property (defined below) in accordance with and subject to any and all existing City development regulations and conditions of approval of the City as they exist on the effective date of the Rezoning (defined in Section 2 below), subject to the terms, conditions, and exceptions contained herein and subject to periodic potential amendments to this Agreement made in accordance with this Agreement.

WHEREAS, Developer intends to develop the improvements set forth below on the Developer Property pursuant to a rezoning of the Developer Property to the Innovative Development District designation (See Section 2.11 of the City of Simpsonville Zoning Ordinance "Zoning Ordinance"), which requires, among other things, City approval of a concept plan and master site plan pursuant to the terms of Section 2.11, the terms and conditions of which are incorporated herein as if set forth fully.

NOW, THEREFORE, in consideration and mutual dependence on the factual representations

contained in this Agreement, the Recitals set forth hereinabove, each Party's expending funds to complete their respective portions of the Development, and in reliance on each Party's exchange of promises as contained in this Agreement, the Parties agree as follows:

1. **City's Approval of Agreement:** The terms and conditions of this Agreement have undergone extensive review by City Council (the "Council") and Council has determined this Agreement to be fair, just, reasonable, and in the best interests of the City. After careful review and deliberation, the Council has determined and concluded that the Agreement meets the goals and needs of the City and complies with all statutory requirements.

On July 8, 2025, the Council considered and approved this Agreement by ordinance and authorized the City's execution of the same. The approval of this Agreement constitutes a legislative act of the Council.

2. **Rezoning of Developer Property.** In order for Developer to undertake the Project, City and Developer acknowledge the Developer Property must be rezoned from its current Business Urban zoning classification to the Innovative Development District (ID) zoning classification (the "Rezoning") as set forth under Section 2.11 of the City's zoning ordinance (the "Zoning Ordinance") in effect as of the Effective Date. The terms of Section 2.11 of the Zoning Ordinance are hereby incorporated into the terms of this Agreement. To effectuate such Rezoning, Developer agrees to submit appropriate and applicable documentation to request the Rezoning of the Property as soon as reasonably possible upon receipt of the fully effective Agreement. City agrees to use its reasonable best efforts to assist Developer in obtaining the Rezoning. This Agreement shall terminate automatically in the event the Rezoning of the Developer Property is not obtained. In the event Developer does not obtain the Rezoning of the Property, Developer shall have the right in its complete and sole discretion to either (i) terminate the PSA by delivery of written notice to City prior to the Closing Date set forth in the PSA, or (ii) waive such right and complete the acquisition of the City Property.

3. **Expansion of Developer Property.** Developer is attempting to acquire, lease or otherwise control some or all of the property currently owned by Secured Advantage Credit Union being more particularly described on Exhibit C attached hereto and made a part hereof (the "Credit Union Property"), to be utilized as part of the Project. In the event that Developer is able to accomplish the same, the portion of the Credit Union Property, Developer either acquires or leases shall become part of the Developer Property. The Parties shall thereafter amend this Agreement to include the Credit Union Property as part of the Developer Property.

4. **SC Mill Tax Credits.** Developer may elect to undertake appropriate actions with Greenville County in order to request and obtain a satisfactory resolution and a subsequent ordinance confirming that tax credits under the South Carolina Textiles Communities Revitalization Act, Section 12-67-140, et. seq., of the South Carolina Codes of Laws (the "Mill Tax Credits"), shall be applicable and available with respect to all or a portion of the Developer Property. City agrees to use its reasonable best efforts to assist Developer in obtaining the Mill Tax Credits.

5. **Developer Commitments and Benefits.**

A. **Development on Developer Property.** Developer shall acquire the City Property from the City subject to the terms of the PSA. Developer shall design, develop, construct, furnish, and do all other things necessary to redevelop, construct and operate on the Developer Property (i) up to one hundred twenty five (125) apartment units with related amenities for tenants of the apartments, (ii) up to 25,000 square feet of retail, restaurant or office space; and (iii) a surface parking lot with parking to accommodate the development with vehicular and pedestrian access to and from all improvements (collectively the "Project")

or "Burdette North District Redevelopment") in compliance with all requirements set forth in Section 4.5 of the Simpsonville Zoning Ordinance, the approved Concept Plan/Statement of Intent, and DO-TC 2.12, Design Overlay-Town Center District, as preliminarily illustrated in the drawing attached hereto as Exhibit D (the "Project Facilities") and as will be fully described on the Master Site Plan approved by Council as part of the Rezoning. The Project shall be constructed according to the Construction Schedule attached hereto as Exhibit E (the "Construction Schedule"), which may be adjusted based upon the Construction Commencement Date defined below. Developer shall use its reasonable best efforts to achieve substantial completion of the Project by June 30, 2028. For purposes of this Agreement, "substantial completion" means that the buildings and improvements for the Project Facilities are sufficiently complete so that it can be utilized for their intended use. Developer shall commence site demolition, grading, and construction after it acquires the City Property pursuant to the PSA and as soon as reasonably possible upon receipt of applicable permits and approvals after Developer acquires the City Property from the City ("Construction Commencement Date"). The Construction Commencement Date and the dates provided on the Construction Schedule are each a "Benchmark Date" and Developer's failure to comply with the same is enforceable against the Developer as set forth in Section 6(F) hereof.

B. Design Considerations. At a minimum, Developer shall design all improvements on the Developer Property in compliance with City's Building & Development Standards in the Zoning Ordinance, including Section 2.11 of the Zoning Ordinance, and must receive all required approvals by City's Department of Building & Development Standards prior to commencing each phase of construction. Developer shall submit the design of the buildings on the Developer Property to be approved by City Planning Staff subject to the plans approved by Council. Developer shall design and construct the Project Facility on Developer's Property of a scale and using materials to be complementary of public improvements and to be compatible with existing downtown buildings and other downtown development.

C. Compliance with Building, Zoning, and Environmental Laws. Subject to the Rezoning necessary in order for Developer to develop the Project Facilities as described in this Agreement, including without limitation, waiver of setback lines and height restrictions for the Developer Property, Developer shall construct and develop the Project Facilities according to all applicable federal, state, and local laws, rules, orders, ordinances, regulations, and legal requirements of all governmental entities, agencies, or instrumentalities relating to the development, use, or condition of Developer Property, including, without limitation, all building code, zoning requirements, and environmental regulations then in effect at the latter of the time applicable permits are issued and a certificate of occupancy is issued. At the completion of each phase or component of the Project Facilities, Developer shall ensure the use and operation of each phase or component of the Project Facilities is according to all applicable federal, state, and local laws, as amended for the Project Facilities. Developer shall (i) ensure construction is performed in a manner that does not cause any damage to existing land, or improvements and (ii) at City's option, promptly repair any damage that may occur.

D. General Construction Requirements. The Developer is responsible for the following items during all construction phases:

- a. Cleanliness to include entire worksite area (including, for example, dust control, garbage, construction debris, loose and blowing materials);
- b. Damage to existing on-site utilities, including, for example, water, sewer, storm water, communication, electricity, and gas;
- c. Parking for construction employees, material lay-down area, location for construction material dumpsters;

- d. Coordination with existing businesses and residents regarding noise, displaced parkers, after-hours construction, concrete pours, blasting, disruption of vehicle and pedestrian access; and
- E. Additional Developer Benefits. The general benefits to be received by Developer from the implementation of the Development, in addition to certain matters set forth above, include without limitation:
 - a. Realization of the opportunity to implement the Development plan for a mixed use development that is consistent with City's and the Developer's goals and needs;
 - b. Integration of site plans, urban design elements, land uses, architecture, site engineering, landscape architecture, and mitigation measures over the entire Project;
 - c. Security provided by certain City ordinances, standards, policies, and guidelines to achieve the Project;
 - d. Participation by the City to achieve the public benefits necessary for the Project; and
 - e. In exchange for providing the within benefits to the City, the Developer desires to receive the assurance that it may proceed with the Project in accordance with any and all existing City development regulations and conditions of approval of the City as they exist on the Effective Date, subject to the terms, conditions, and exceptions contained herein and subject to periodic potential amendments to this Agreement made in accordance with this Agreement.

6. City Commitments

- A. Rezoning. The City acknowledges that a condition to Developer's obligations herein is that the Developer receive the Rezoning so that Developer can develop the Project Facilities as described in this Agreement.
- B. Streetscape Improvements. City agrees to complete the streetscape and other public improvements planned for the area contiguous and adjacent to the Developer Property which are set forth on Exhibit F attached hereto and made a part hereof (the "Streetscape Improvements") at its expense prior to Developer's completion of the Project.
- C. Undergrounding Utilities. Prior to Developer's completion of construction of Project Facilities, City agrees to either complete, or facilitate the completion with Duke Energy, of the undergrounding utilities along College Street and Main Street in front of the Developer Property at no expense to Developer.
- D. Street Narrowing. City shall use its reasonable best efforts to cause the portion of Hedge Street that is contiguous to the Developer Property shown and depicted on the drawing attached hereto as Exhibit G to be narrowed to allow for additional parking on the Developer Property at no expense to Developer.
- E. Permitting. To the extent permitted by law and for those items under City control, the City shall attempt to expedite the processing, approval, and permitting of drawings, plats, plans, applications, and other items for and pertaining to all phases of the Project.
- F. Benchmark Dates. If Developer fails to accomplish any required task by that required task's applicable benchmark date, then, in addition to any other remedy provided under this Agreement, City may delay its performance of any obligation under this Agreement for a similar period.

7. Design and Construction Processes

- A. Designated Contact. Immediately following this Agreement's execution, City and Developer shall each designate a senior-level contact to represent that Party (each a "Designated Contact"). Designated Contacts shall address, without delay, issues related to scheduling, traffic control, utility coordination, and a process for reviewing and revising plans and specifications. Each Party shall provide that Party's communications through that Party's Designated Contact.
- B. Pre- and During Construction. Prior to preparing any plans or specifications, and through the construction process, the City and Developer shall confer on the needs, preferences, and expectations each Party has for its respective project and as much as possible achieve common goals as to how to achieve those goals. The process Parties outline in this subsection is in addition to and not in lieu of all approval and permitting processes applicable to all persons and entities developing projects in city limits.

8. Bonds and Insurance

- A. Insurance. During construction, the Developer shall obtain and maintain, or cause to be obtained and maintained, at all times one or more policies of insurance containing the following types of coverage, deductibles, limits, and other terms acceptable to the City, in its sole discretion:
- a. Builders Risk. Comprehensive builders' risk, casualty, and property insurance against any casualty on an "all risk" perils basis. This policy must include fire, extended coverage, vandalism, and malicious mischief.
 - b. General Liability. Commercial general liability insurance covering the defense and legal liability claims of bodily injury, death and property damage which occurs on, in or about or relating to the Developer Property regardless of the cause of the same. This policy must have not less than \$3,000,000 combined single limits per occurrence/aggregate for bodily injury or property damage, provided by a Commercial General Liability policy or combination of General Liability and Umbrella Liability limits.
 - c. Workers Compensation. Workers Compensation and Occupational Disease insurance meeting the State's statutory requirements, including employer's liability in an amount not less than \$1,000,000.
 - d. Motor Vehicle. Motor vehicle covering all owned, non-owned and hired automobiles of not less than \$1,000,000 combined single-limits per each occurrence/aggregate for liability, bodily injury, and property damage.
 - e. Miscellaneous. Insurance this Agreement requires must be effected under standard form policies issued by insurers of recognized responsibility authorized to do business in South Carolina which are rated at least Class A/VIII, Best Rating Services. The policies must be non-assessable and shall contain language to the effect that (i) any loss shall be payable notwithstanding any act of negligence, (ii) the policies are primary and noncontributing with insurance on which additional insured's are listed as named insured's, and (iii) the insurer is not entitled to initiate cancellation, material limitation or non-renewal except after 30 days' written notice for cancellation due to non-payment of premium) by the insurer to the Developer and City. The policies must include waivers of all rights of subrogation against the Developer, City and their respective elected officials, officers, agents, and employees. The policy described in subparagraphs (a) , (b) , and (d) of this section must include the City and Developer, and their respective elected officials, officers, agents, employees, subcontractors, and licensees as additional insureds to the extent allowed by law. The policy described in subparagraphs (e) of this section must include the

Developer as an additional insured. Each policy must contain deductibles, retentions, or both, as City, in its sole discretion, deems appropriate.

9. Damage or Destruction Prior to Substantial Completion

If, at any time prior to substantial completion, the Project is damaged or destroyed by a fire or other casualty, the Developer shall commence, and proceed as promptly as possible, to repair and restore the Project Facilities so as to cause the same to achieve substantial completion according to approved architectural drawings as soon as practicable.

10. Cooperation

Parties shall work together to correct and conform deeds, assignments, or other conveyance instruments, to reflect as-built configurations. A Party may not unreasonably withhold consent.

11. Default / Remedies

- A. Developer. Upon the default by the Developer in the due performance of or compliance with any of the terms hereof, City shall give Developer written notice of such default and thirty (30) days to cure such default; provided, however, that if the nature of Developer's obligation is such that more than thirty (30) days are required for its performance, and so long as Developer has provided written notice of the precise time frame for completion, then Developer shall not be deemed in default if it shall commence such performance within thirty (30) days and thereafter diligently pursues the same to completion, and if Developer shall fail to proceed promptly to cure the same, City may:
- a. terminate this Agreement immediately by delivery of written notice to Developer; and,
 - b. take whatever action at law or in equity as may appear necessary or desirable to enforce its rights under this Agreement; and,
- B. City. Upon the default of the City in the due performance of or compliance with any of the terms hereof, the Developer shall give the City written notice of such default and 30 days to cure such default; provided, however, that if the nature of City's obligation is such that more than thirty (30) days are required for its performance, and so long as City has provided written notice of the precise time frame for completion, then City shall not be deemed in default if it shall commence such performance within thirty (30) days and thereafter diligently pursues the same to completion and if the City shall fail to proceed promptly to cure the same, the Developer may take whatever action at law or in equity as may appear necessary or desirable to enforce its rights under this Agreement.

12. Developer Property Restriction.

In the event that Developer has both (i) acquired the City Property and (ii) entered into this Agreement with the City, Developer shall record a covenant against the Developer Property, to run with the Developer Property, that the Developer Property shall not, for a period of twenty (20) years, be transferred to, owned by, or used, by any person (legal or natural) that would result in the Developer Property, or any portion (legal or geographic), having a complete exemption from *ad valorem* property taxes without the written approval of the City; provided, however, such covenant shall not preclude or prevent Developer or a subsequent owner or user of the Developer Property, or any portion thereof, from applying for and receiving the benefit of an applicable property tax classification that would reduce, lower or otherwise benefit the *ad valorem* property taxes applicable to the Developer Property or any portion thereof (such as, for example, (i) a fee in lieu of taxes agreement with the City or (ii) ownership by a 501(C)(3) non-profit entity).

13. Entire Agreement

This Agreement is the entire agreement among Parties with respect to the subject matter of this Agreement. All prior documents, negotiations, and discussions merge in this Agreement and do not survive this Agreement's execution.

14. No Oral Modification/Waiver

Parties are not entitled to modify, in any way, this Agreement except by a writing signed by or on behalf of all Parties by a duly authorized representative of the executing Party. Neither any purported amendment, of any kind, to this Agreement, nor any purported waiver of any provision of this Agreement is valid unless all Parties have consented in writing.

15. Non-Assignment

A Party shall not assign its rights or delegate its responsibilities under this Agreement to any third party without the prior, written consent of all Parties; provided, however, the Parties recognizes that Developer shall be permitted to assign its interest in this Agreement to an entity created for the purpose of acquiring, owning and developing the Developer Property in which Developer or its principals own(s) an interest. Notwithstanding the foregoing, the City is entitled to assign some or all of its rights or delegate some or all of its duties under this Agreement to a nonprofit corporation to effect a means of financing the City's project costs. City is not required to obtain any further consent from any other Party beyond this Agreement's execution for that purpose.

16. Mutual Dependency of Commitments

Each Party's commitments under this Agreement are collectively dependent, each on the other, and are subject to the condition that each Party continues to move toward completion of that Party's projects on collectively acceptable terms and conditions of all documents contemplated by this Agreement.

17. No Third-Party Beneficiary/No Joint Venture

The Parties do not intend to create any third-party beneficiary rights, nor any form of partnership, joint venture, or any other legal relationship among the Parties, except a contractual relationship as set forth in this Agreement.

18. Force Majeure

Neither party shall be held responsible for delays in the performance of its obligations hereunder when caused by a Force Majeure event. In order for its performance to be excused for the period of a Force Majeure event, a party must give written notice to the other party within 10 days after the occurrence of the Force Majeure event. A Force Majeure event is any period of delay which arises from or through: Acts of God, including, without limitation, flood, earthquake, and severe weather conditions; strikes; explosion; sabotage; riot or civil commotion; act of war; fire or other casualty; legal requirements; or any other causes beyond the reasonable control of the party claiming delay from or through such causes.

19. Limitation of City's Liability

NOTWITHSTANDING ANYTHING ELSE IN THIS AGREEMENT TO THE CONTRARY, ANY CITY OBLIGATION CONTAINED IN THIS AGREEMENT, INCLUDING ANY OBLIGATION TO PAY MONEY, IS NOT A DEBT OR GENERAL OBLIGATION OF CITY, BUT RATHER IS PAYABLE SOLELY AND EXCLUSIVELY FROM ANNUALLY APPROPRIABLE REVENUES AND RECEIPTS

OF CITY'S GENERAL OPERATIONS.

20. No City Personnel Liability

Any City obligation contained in this Agreement, including any obligation to pay money, is an obligation of the City and not an obligation of any member of the City Council or any employee, other elected official, officer, or agent of the City in either an individual or an official capacity.

21. Absence of Certain Commercial Practices

Neither Developer nor any officer, member, director, employee or agent of them (nor any person acting on behalf of any of the foregoing), has given or agreed to give any gift or similar benefit, including, without limitation, any contribution, payment or expenditure, of more than normal value to any customer, supplier, City or other governmental employee or official or any other person who is or may be in a position to help or hinder the foregoing entities or assist them in connection with any actual or proposed activity described in this Agreement.

22. Governing Law; Venue

The law of the State, without regard to any conflict of law provision that would direct a court to use the laws of another jurisdiction, govern this Agreement. The Parties submit to venue and jurisdiction in the state and federal courts of the State.

23. State Law Limitations

Notwithstanding anything else in this Agreement to the contrary, the City's commitments are subject to the provisions of the South Carolina Code Annotated, as well as all local laws.

24. Developer and City Responsibility.

Developer, and its officers, directors and employees, agree to hold the City harmless from all claims, liabilities, damages, losses, including attorney's fees and expenses for bodily injury, sickness or death, and property damage or destruction which may be claimed against the City due to any acts or omissions by the Developer or its officers, employees or agents related to the administration of the Project. The City is a governmental entity and political subdivision of the State of South Carolina and enjoys sovereign immunity, as well as the imposition of duties and protections afforded by the South Carolina Tort Claims Act. By law, the City cannot hold harmless any contracting party. However, subject to the application of the aforementioned law and to the limits of its insurance, the City agrees that the Developer, and its officers, directors and employees shall not be liable from and against all claims, liabilities, damages, losses, including attorney's fees and expenses for bodily injury, sickness, or death, and property damage or destruction (other than to the Work itself) related to the negligent acts or omissions by the City, and the Developer's officers, employees, and agents.

25. Dispute Resolution.

(a) In the event of a dispute arising under this Agreement, the parties agree to engage in good faith discussions to resolve the matter amicably.

(b) If the dispute cannot be resolved through discussions, the parties agree to participate in non-binding mediation, with a mutually agreed-upon mediator, as a condition precedent to further legal proceedings.

(c) If mediation is unsuccessful, the parties agree to submit venue and jurisdiction in the state or federal courts located in County of Greenville, State of South Carolina.

(d) Each party shall bear its own costs of mediation, except that the costs of the mediator or shall be shared equally .

26. Benefit of the Parties.

This Agreement is intended to benefit the Parties hereto only, and therefore no third party shall have any rights under this Agreement, or be deemed a third-party beneficiary.

27. Notices.

Unless specifically provided otherwise by this Agreement, any notice, demand, request, consent, approval or communication which a Party is required to or may give to another Party hereunder shall be in writing and shall be delivered or addressed to the other at the address below set forth or to such other address as such Party may from time to time direct by written notice given in the manner herein prescribed. Any written notice or written certification or payment required by the Terms of this Agreement shall be deemed given if delivered in person or mailed certified mail, return receipt requested to the persons named below. The Parties shall make reasonable inquiry to determine whether the names or titles of the persons listed in this Agreement should be substituted with the name of the listed person's successor.

If to the City:

Attn: Tee Coker
425 E. Curtis Street
Simpsonville, SC 29681
Email: tcoker@simpsonville.com

With a copy to:

Duggan & Hughes, LLC
Attn: Daniel R. Hughes
P.O. Box 449
Greer, SC 29652
Email: dhughes@dugganhughes.com

If to Developer:

Blue Ridge Land Holdings, LLC
Attn: John T. Pazdan
P. O. Box 8856
Greenville, SC 29604
Email: chanticleer18@gmail.com

With a copy to:

Belmont Sayre, LLC
Attn: Kenneth M. Reiter
P. O. Box 1622
Carrboro, NC 27510
Email: kreiter@belmontsayre.com

28. **Jurisdiction.** This Agreement shall be binding upon the parties hereto and governed by the laws of the State of South Carolina.

29. **Counterparts.** This Agreement may be executed in one or more counterparts and shall become effective when one or more counterparts have been signed by all of the Parties; each counterpart shall be deemed an original but all counterparts shall constitute a single instrument.

30. **Agreement to Cooperate.** In the event of any legal action instituted by a third party or other governmental entity or official challenging the validity of any provision of this Agreement, the Parties hereby agree to cooperate in defending such action; provided, however, each Party shall retain the right to pursue its own independent legal defense.

31. **Severability.** In the event that a court of competent jurisdiction holds that a provision or requirement of this Agreement violates any applicable law, each such provision or requirement shall be replaced with a revision which accomplishes the purposes outlined herein and shall be enforced only to the extent it is not in violation of law or is not otherwise unenforceable and all other provisions and requirements of this Agreement, not contingent thereon, shall remain in full force and effect.

34. **Organization and Power.** Developer represents and warrants to the City that it (i) is a limited liability company organized, validly existing, and in good standing under the laws of the State of South Carolina, (ii) has the power to engage in the transactions contemplated hereby; and (iii) has the full power, authority and legal right to execute and deliver this Agreement and other documents and to perform and observe the terms and provisions thereof. The City represents and warrants to Developer that it has the right, power and authority to execute and deliver this Agreement and to perform and observe the terms thereof. This Agreement, when executed and delivered by the parties, is a valid and binding obligation of the parties and is enforceable in accordance with its terms, subject to the conditions precedent set forth above.

[ONE SIGNATURE PAGE AND ONE EXHIBIT FOLLOW]
[REMAINDER OF PAGE SUBSTANTIALLY BLANK]

WHEREFORE by its signature, the City binds itself and successors in interest as of the effective date provided in this Agreement's preamble.

CITY OF SIMPSONVILLE, SOUTH CAROLINA

By 
_Paul Shewmaker, Mayor

[SEAL]

ATTEST:

Ashley Clark, Municipal Clerk

Date of Execution: July 8th, 2025

[SIGNATURES CONTINUE ON THE FOLLOWING PAGE]

WHEREFORE by its signature, Developer binds itself and its successors in interest as of the effective date provided in this Agreement's preamble.

BLUE RIDGE LAND HOLDINGS, LLC

By: _____
John T. Pazdan, Member

Date of Execution: _____, 2025

EXHIBIT A

DESCRIPTION OF CITY PROPERTY

All that certain piece, parcel or tract of land with improvements thereon situate, lying and being in the City of Simpsonville, County of Greenville, State of South Carolina, containing 1.42 acres, more or less, bound on the north by lands now or formerly of United Federal Savings & Loan Association and Wesley V. Harrison, on the east by Hedge Street, on the south by lands now or formerly of Hendricks Properties, Inc., and on the west by N. Main Street.

This being the identical property conveyed to City of Simpsonville, a municipal corporation, by deed of Duke Power Company, dated June 6, 1996, and recorded August 13, 1996, in the Greenville County ROD Office in Deed Book 1649 at Page 1669.

TMS 0315.00-02-004.00

EXHIBIT B

DESCRIPTION OF FORMER BANK PROPERTY

Parcel 1:

All that certain piece, parcel, or lot of land, situate, lying and being in the Town of Simpsonville, County of Greenville, State of South Carolina, at the southeast corner of College and North Main Streets, and having, according to a survey made by Piedmont Engineering Service on October 2, 1951, the following metes and bounds, to-wit:

BEGINNING at the southeast intersection of College and North Main Streets, and running thence with North Main Street, S. 25-23 E., 128 feet to an iron pin; thence N. 64-24 E., 100 feet to an iron pin; thence N. 25-23 W., 129.7 feet to an iron pin on the south side of College Street; thence with the south side of College Street; thence with the south side of College Street, S. 63-36 W., 100 feet to the point of beginning.

Parcel 2:

ALL that lot of land, with improvements thereon, situate on the Southeastern side of College Street, Town of Simpsonville, Austin Township, Greenville County, State of South Carolina, shown as a portion of Lot No. 1, on Map No. 1, of A. R. Hunter Estate, made by W. J. Riddle, August, 1947, and having, according to said Map, the following metes and bounds, to-wit:

BEGINNING at an iron pin on the Southeastern side of College Street, said point being 100.ft. in a Northeasterly direction from the point where the Northeastern side of North Main Street intersects with the Southeastern side of College Street, and running thence with the Southeastern side of College Street, N. 63-35 E. 132 ft, to an iron pin with the line of Lot No, 4; thence S. 26-42 E., 131.5 ft. to an iron pin; thence with the line of Lot No, 2, S-64-24 W, 134 ft. to an iron pin in the joint line of Lots 1 and 2, said point being 100 ft, in a Northeasterly direction from the joint front corner of Lots 1 and 2; thence through Lot No. 1 N. 25-23 W., 131 ft., more or less, to the beginning corner.

Parcel 3:

ALL that certain piece, parcel or lot of land, with all improvements thereon, containing 0.37 acres, more or less, situate, lying and being in the Town of Simpsonville, County of Greenville, State of South Carolina, located at the southwestern corner of the intersection of West Hedge Street and East College Street, and being shown on a plat entitled Survey for S & S Properties, a South Carolina General Partnership, prepared by Landrith Surveying, dated February 1, 1990, recorded in Plat Book 18-G at Page 11, and having, according to a survey entitled "Property of American Federal Bank, FSB", prepared by Freeland-Clinkscales & Associates, Inc., dated July 23, 1992, recorded in Plat Book 23-F at Page 35, the following metes and bounds, to-wit:

BEGINNING at an iron pin on the southern side of College Street at the joint corner of Lots 1 and 4; thence with said College Street N 63-35-00 E 132.99 feet to an iron pin at the intersection of College Street and Hedge Street; thence with the south-stern side of Hedge Street S 20-21-39 D 131.00 feet to an iron pin at the joint corner of Lots 2 and 4; thence with the common line of said properties S 63-08-00 W 118.47 feet to an iron pin at the joint corner of Lots 1 and 4; thence with the common line of said properties N 26-43-23 W 131.20 feet to an iron pin, the point of BEGINNING.

BEING ALSO DESCRIBED AS FOLLOWS:

All that certain piece, parcel or tract of land with improvements thereon situate, lying and being in the State of South Carolina, County of Greenville, City of Simpsonville, adjacent to North East Main Street, College Street and Hedge Street, identified as Lot 1 & 4, Map No. 1, A. R. Hunter Est., containing 1.069 Acres, 46,548 Sq. Ft., more or less, on a survey entitled SURVEY FOR BLUE RIDGE LAND HOLDINGS LLC, prepared by Site Design, Inc., dated March 22, 2021, and recorded May 7, 2021, in the Greenville County ROD Office in Plat Book 1397 at Page 56, reference to said survey being hereby made for a more complete metes and bounds description thereof.

This being the identical property conveyed to Blue Ridge Land Holdings, LLC, a South Carolina limited liability company, by Truist Bank, a North Carolina banking corporation, by (i) warranty deed dated April 28, 2021, and recorded May 7, 2021, in the Greenville County ROD Office in Deed Book 2623 at Page 2891, and (ii) quitclaim deed dated April 28, 2021, and recorded May 7, 2021, in the Greenville County ROD Office in Deed Book 2623 at Page 2899.

TMS0315.00-02-001.00

EXHIBIT C

DESCRIPTION OF CREDIT UNION PROPERTY

Tract A:

ALL THAT PIECE, PARCEL OR LOT OF LAND IN SIMPSONVILLE TOWNSHIP, GREENVILLE COUNTY, STATE OF SOUTH CAROLINA, SHOWN ON PLAT OF PROPERTY ENTITLED D. L. BRAMLETT, JR., MADE BY C.O. RIDDLE, DATED AUGUST 1960 AND RECORDED IN THE ROD OFFICE FOR GREENVILLE COUNTY IN PLAT BOOK OO AT PAGE 534 AND 535, AND HAVING, ACCORDING TO SAID PLAT, THE FOLLOWING METES AND BOUNDS, TO-WIT:

BEGINNING AT AN IRON PIN ON THE EASTERN SIDE OF NORTH MAIN STREET, 48.1 FEET NORTH OF THE INTERSECTION OF EAST CURTIS STREET AND RUNNING THENCE ALONG THE EASTERN SIDE OF NORTH MAIN STREET N 22-48 W, 133.3 FEET TO AN IRON PIN AT THE CORNER OF PROPERTY THIS DAY CONVEYED TO GEO. A. WEBB; THENCE ALONG SAID PROPERTY N 70-47 E, 334.8 FEET TO AN IRON PIN ON THE WESTERN SIDE OF HEDGE STREET; THENCE ALONG SAID STREETS 15-10 E, 68.7 FEET TO AN IRON PIN AT THE CORNER OF PROPERTY NOW OR FORMERLY OF ETHEL M. HILL; THENCE S 64-50 W ALONG THE HILL AND MAYFIELD PROPERTIES, 102 FEET TO AN IRON PIN; THENCE S 65-44 W, ALONG THE CANNON, HAYNES AND TODD PROPERTIES 75 FEET TO AN IRON PIN; THENCE S 23-56 E, 30 FEET TO AN IRON PIN; THENCE ALONG THE TOWN PROPERTY S 66-35 W, 30 FEET TO AN IRON PIN; THENCE S 23-56 E, 9 FEET TO AN IRON PIN; THENCE S 66-35 W, 19.5 FEET TO AN IRON PIN; THENCE S 23-56 E, 3.83 FEET TO AN IRON PIN; THENCE ALONG PROPERTY OF WOOTENCORPORATION, JONES AND BRAMLETT, S 67-12 W, 99.3 FEET TO THE POINT OF BEGINNING.

Tract B:

ALL THAT CERTAIN PIECE, PARCEL OR LOT OF LAND IN GREENVILLE COUNTY, STATE OF SOUTH CAROLINA, LOCATED ON THE EASTERLY SIDE OF MAIN STREET IN THE TOWN OF SIMPSONVILLE, AND BEING DESCRIBED AS FOLLOWS:

BEGINNING AT AN IRON PIN ON THE EASTERLY SIDE OF MAIN STREET IN THE TOWN OF SIMPSONVILLE AND RUNNING THENCE N 74-56 E, 172.5 FEET TO AN IRON PIN; THENCE N 75-02 E 164.6 FEET TO AN IRON PIN ON THE WESTERLY SIDE OF HEDGE STREET; THENCE WITH PROPERTY OF GRANTEE HEREIN S 70-47 W, 334.8 FEET TO AN IRON PIN ON THE EASTERLY SIDE OF MAIN STREET; THENCE WITH THE EASTERLY SIDE OF MAIN STREET N 22-48 W, 23.75 FEET TO AN IRON PIN, THE BEGINNING CORNER.

Tract C:

ALL THAT CERTAIN PIECE, PARCEL OR LOT OF LAND LYING, BEING SITUATE IN THE COUNTY OF GREENVILLE, STATE OF SOUTH CAROLINA, BEING SHOWN AND DESIGNATED ON A PLAT ENTITLED "DUKE POWER COMPANY, SIMPSONVILLE BRANCH OFFICE"

DATED DECEMBER 22, 1987 AND HAVING, ACCORDING TO SAID PLAT, THE FOLLOWING METES AND BOUNDS, TO-WIT:

BEGINNING AT AN IRON PIN FOUND ALONG THE EASTERN EDGE OF S. C. HIGHWAY 14 AND U.S. HIGHWAY 276 (N. MAIN STREET) JOINT CORNER OF A 1.42 ACRE TRACT AND RUNNING THENCE N 68-1-51 E, 339.23 FEET TO A PK NAIL IN ROAD ALONG THE WESTERN EDGE OF W. HEDGE STREET; THENCE RUNNING ALONG THE WESTERN EDGE OF W. HEDGE STREET 15-21-15 E, 38.00 FEET TO A PK NAIL IN ROAD ALONG THE WESTERN EDGE OF W. HEDGE STREET; RUNNING THENCE S 74-39-45 W, 337.10 FEET TO AN IRON PIPE FOUND ALONG THE EASTERN EDGE OF S.C. HIGHWAY 14 AND U.S. HIGHWAY 276 (N. MAIN STREET), THE POINT OF BEGINNING.

This being the identical property conveyed to Secured Advantage Federal Credit Union by deed of Pontus Vault Portfolio, LLC dated August 28, 2024, and recorded September 20, 2024, in the Greenville County ROD Office in Deed Book 2731 at Page 2652, which deed corrects a prior deed between the parties recorded June 12, 2019, in Deed Book 2568 at Page 1149.

TMS 0315.00-02-006.00

EXHIBIT D

DEPICTION OF PROJECT FACILITIES

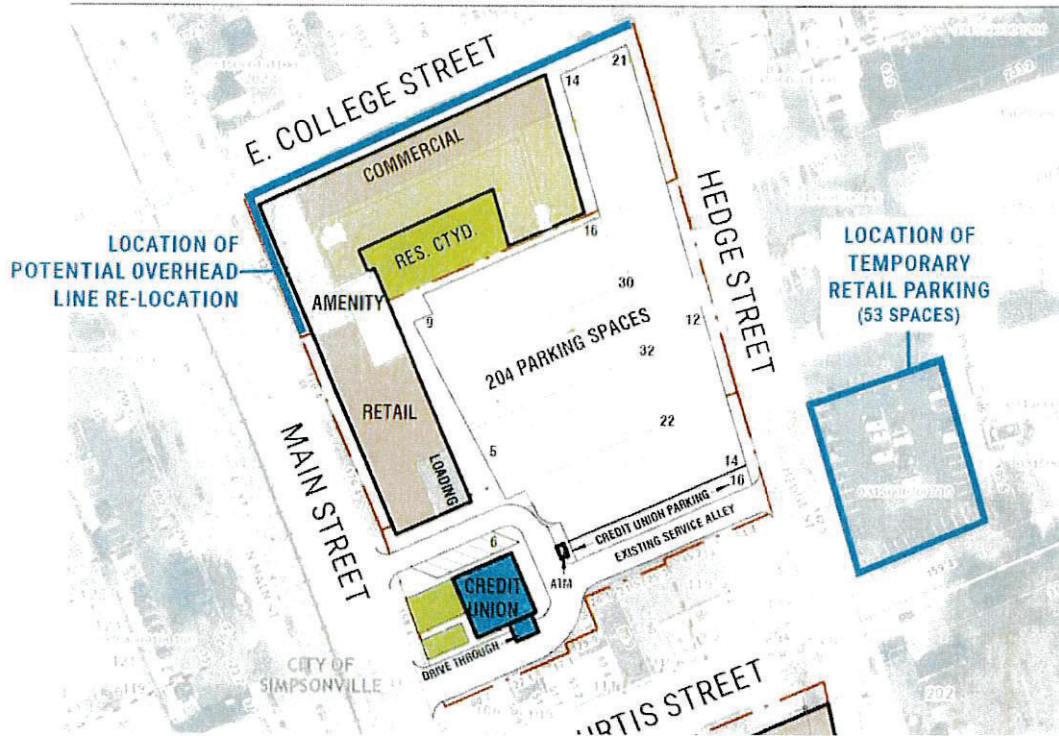

EXHIBIT E

CONSTRUCTION SCHEDULE

September 30, 2025 – Developer obtains Rezoning.

March 31, 2026 – Design and construction plans for the Project finalized and submitted to the City.

June 1, 2026 -- Building and site construction and land disturbance permits issued.

June 30, 2028 – Project construction completed and leasing commences. Residents and businesses begin to take occupancy.

EXHIBIT F
STREETScape IMPROVEMENTS

EXHIBIT G

AREA OF HEDGE STREET TO BE NARROWED

[ATTACHED ON THE FOLLOWING PAGE]



City of Simpsonville – Submission of Agenda Item

(Due at 12 p.m. on the Tuesday prior to the meeting)

To: Ashley Clark, Clerk of Council

From: Jon Derby

Department: Planning

Date Submitted: 04/06/2026

Please include the following item on the agenda for:

- Committee of the Whole Meeting (4th Tuesday of the month) **Date:**
- Business Meeting (2nd Tuesday of the month) **Date:** 04/14/2026

Agenda Item Title: A. Second Reading of Ordinance O-2026-03, to amend Division 2 (Junk or Abandoned Vehicles) of Article 2 (Nuisances) of Chapter 18 (Environment)

Summary of Item / Purpose:

Amendments to Chapter 18, Article II, Division II, Section 18-61 for the location permitting and prohibiting derelict vehicles by clarifying language better defining nuisance and appropriate storage

Action Requested of Council:

- Discussion Only
- First Reading
- Second Reading
- Approval / Vote
- Other:

Are supporting documents attached?

- Yes No

AGENDA ITEM

To: City Council

Meeting Date: 4/14/2026

Agenda Item: O-2026-03, Code of Ordinance, Derelict Vehicle

Subject: Second Reading - Amendments to Chapter 18, Article II, Division II, Section 18-61

Attachments: Proposed Code of Ordinance Proposed Zoning Ordinance
 Discussion from Council Locations Maps Petitions
 Traffic Study Supp. Sections of the Code

Brief Description of Request

From time-to-time staff discovers areas of the City Code of Ordinance that may need some refinement. In this case, staff has requested changes to the sections listed below.

Section(s)	Amendment	Reason
18-61	To Amend the location permitting & prohibiting derelict vehicles	Clarify language that better defines the nuisance and the appropriate storage.

Council Committee of the Whole

Nothing has changed since 1st Reading on March 10th.

Staff Comments

The current language for §18-61 (Abandonment prohibited; junk motor vehicle defined), defines what a junk vehicle is and provides permitted location options to allow junk vehicles within a property. These location options are also mentioned in the exception portion of *Derelict Motor Vehicle* definition § 18-36 *Definitions*. However, Section 18-61 further explains that junk vehicles can be stored in “areas” in addition to a 3-sided building or enclosed building. This term, “area” is not mentioned in the definition Section of 18-36 as an option nor is it defined. With junk vehicles being synonymous with derelict vehicles, it can create confusion or inconsistency within the intent of the code.

Staff has requested this portion be removed and better clarify the allowable locations.

**AN ORDINANCE TO AMEND DIVISION 2 (JUNK OR ABANDONED
VEHICLES) OF ARTICLE II (NUISANCES) OF CHAPTER 18
(ENVIRONMENT) OF THE CITY OF SIMPSONVILLE CODE OF
ORDINANCES**

WHEREAS, the City of Simpsonville City Council reviews its Ordinances at various times to make necessary improvements and/or changes; and,

WHEREAS, the City of Simpsonville desires to amend its existing ordinances regarding the storage of derelict vehicles and junk to resolve conflicting language pertaining to the same.

NOW, THEREFORE, BE IT ORDAINED by the Mayor and Council of the City of Simpsonville as follows:

Section 1. That Division 2 (Junk or Abandoned Vehicles) of Article II (Nuisances) of Chapter 18 (Environment) be amended as follows: [Additions are underlined; deletions are ~~struck through~~.]

Sec. 18-61 – Abandonment prohibited; ~~junk motor vehicle~~

- (a) It shall be unlawful for any person to abandon, accumulate or place or deposit or cause to be placed or deposited on any street, alleyway, or sidewalk, or anywhere within the corporate limits of the city, other than within an enclosed building ~~or area~~ any of the following: derelict motor vehicles (as defined herein) or junk, old automobiles, including old vehicles or parts of old automobiles, or vehicles, except those as may be approved by the City Council. The foregoing prohibition shall not apply to derelict motor vehicles or junk, including old vehicle or parts of old automobiles located within a commercial garage, wrecker, or storage facility, which shall be stored in accordance with the Simpsonville Zoning Ordinance.

- (b) Any motor vehicle of which the condition of is wrecked, dismantled, partially dismantled, inoperative, or discarded, and remains so for a period of 30 days, shall be deemed abandoned ~~junk motor vehicle~~.

Section 2. Severability. The provisions of this Ordinance are hereby declared to be severable and if any section, phrase or provision shall for any reason be declared by a court of competent jurisdiction to be invalid or unenforceable, such declaration shall not affect the validity of the remainder of the sections, phrases and provisions hereunder.

Section 3. Suspension of Conflicting Ordinances, Rules, Orders or Resolutions. All ordinances, rules, orders, resolutions and parts thereof in conflict herewith are, to the extent of such conflict, hereby suspended for the duration of this ordinance.

Section 4. Savings Clause: Nothing in this ordinance hereby adopted shall be construed to affect any suit or proceeding in any court, or any rights acquired, or liability incurred, or any cause or causes of action acquired or existing, under any act or ordinance hereby repealed as stated in Section 3 of the ordinance; nor shall any just or legal right or remedy of any character be lost, impaired or affected by this ordinance.

Section 5. Effective Date of the Ordinance. This ordinance shall be effective immediately upon passage.

DONE in meeting duly assembled this ____ day of _____ 2026.

SIGNATURE OF MAYOR:

Paul Shewmaker

ATTEST:

APPROVED AS TO FORM:

Ashley Clark
City Clerk

Daniel Hughes
City Attorney

First Reading: March 10, 2026

Second Reading: April, 14, 2026



City of Simpsonville – Submission of Agenda Item

(Due at 12 p.m. on the Tuesday prior to the meeting)

To: Ashley Clark, Clerk of Council

From: Jon Derby

Department: Planning

Date Submitted: 04/08/2026

Please include the following item on the agenda for:

Committee of the Whole Meeting (4th Tuesday of the month) **Date:**

Business Meeting (2nd Tuesday of the month) **Date:** 04/14/2026

Agenda Item Title: First Reading of Ordinance Z-2026-01, to propose rezoning of property located at 206 Ladean Court

Summary of Item / Purpose:

Rezoning property located at 206 Ladean Court from I-D (Innovative Development) to B-G (Business General) zoning

Action Requested of Council:

Discussion Only

First Reading

Second Reading

Approval / Vote

Other:

Are supporting documents attached?

Yes No

AGENDA ITEM

To: Planning Commission

Meeting Date: 04/14/2026

Agenda Item: Proposed rezoning to B-G

Subject: Z-2026-01 Proposed rezoning to property located at 206 Ladean Ct. Tax Map# 0330.00.01.001.24

Applicant/Owner: Justin A. Holck, Sculetown Real Estate Holdings

Attachments: Proposed Ordinance Proposed Concept Plan
 Proposed Statement of Intent Applicant Material
 Consent Letter Locations Maps Petitions
 Traffic Study Renderings

Existing Zoning	Requested Zoning	Surrounding Zoning	Future Land Use	Size of Property
ID	BG	B-G	Village Activity Center	0.66 +/- Acres

Brief Description of request

The City of Simpsonville has received a signed petition requesting the rezoning of property pursuant to Section 7.5 of the Simpsonville Zoning Ordinance. This petition is for the parcel located at 206 Ladean Ct (tax map # 0330.00.01.001.24)

The applicant has requested that this parcel be rezoned back to B-G, (Business General) from its current zoning of ID (Innovative Development). The applicant would like to market the site under the B-G use and design standards.

Z-2026-01

Location & Site Description

This parcel was rezoned to ID in 2022 for the “Scuffletown Food Truck Park”. This project saw great success over the years. The site layout is still intact for the food park concept. Ingress/egress to the site is still from the private drive via the Fairview Market shopping center besides the Wine Barn (Prior Ace Hardware).

Comprehensive Plan

The City’s Comprehensive Plan identifies this area as Village Activity Center. This designation is intended to promote a mix of uses, of which various commercial uses remain predominant, but where residential, service, and other uses are complementary. Where applied to older highway corridors characterized by commercial “strip” uses, the intent is to encourage infill and redevelopment for a more diverse and attractive mix of uses over time. Ensuring that buildings are of the appropriate scale and intensity is critical, as is ensuring that sites are designed in a coordinated, as opposed to a lot-by-lot, manner. New commercial “strip” development is discouraged.

Zoning District

Per Section 2.8.1 of the Simpsonville Zoning Ordinance: “The B-G, Business—General District is established to promote accessible and central concentrations of business activities and commercial establishments offering both retail goods and services to people from throughout the community. This district also provides opportunities to integrate residential uses subject to careful design. The district is intended to serve both pedestrians as well as people who travel by automobile. Therefore, this district is primarily located along major roadways, and businesses are encouraged to locate in close proximity to one another. Where necessary, adjacent residential areas are protected through landscaping and site design.”

Public Hearing Proceeding

A public hearing regarding this petition was conducted on March 3rd, 2026, before the body of the Simpsonville Planning Commission. There were no public comments.

Planning Commission Review

The Simpsonville Planning Commission reviewed the request to rezone the property at their March 3rd, 2026, meeting. By a vote of 6-0, the Planning Commission recommends approval of Z-2026-01.

Z-2026-01

Site Improvements

No site improvements at this time. The site is still intact from the approved master site plan for the food truck concept. Any new development would adhere to the site standards of Article 4, of the Simpsonville Zoning Ordinance.

Staff Comments

Staff recommends approval.

STAFF RECOMMENDATION: I move that the Planning Commission recommend approval of the requested rezoning set forth in Ordinance Z-2026-01.

ORDINANCE NO. Z-2026-01

**AN ORDINANCE TO AMEND THE ZONING MAP
OF THE CITY OF SIMPSONVILLE, SOUTH
CAROLINA OF LAND AT 206 LADEAN COURT,
TAX MAP# 0330.00-01-001.24, OWNED BY
SCUFFLETOWN REAL ESTATE HOLDING**

WHEREAS, the South Carolina Code of Laws of 1976, as amended, Chapter 23 Title 5 provides for the process for municipalities to rezone property; and

WHEREAS, the City of Simpsonville has enacted a Zoning Ordinance which governs amendments to the Official Zoning Map; and

WHEREAS, the hereinafter described property was advertised on February 16, 2026, and the City of Simpsonville Planning Commission held a public hearing on March 3, 2026.

NOW, THEREFORE, BE IT ORDAINED BY THE CITY COUNCIL OF THE CITY OF SIMPSONVILLE THAT:

1. **ZONING CLASSIFICATION:** The Official Zoning Map of the City of Simpsonville is hereby amended to assign Tax Map # 0330.00-01-001.24 depicted in the deed contained in Book 2682 on Page 72, of the official records of Greenville County Register of Deeds and as depicted in Exhibit "A" & "B", attached hereto, the zoning classification of B-G, Business General District.

2. **PROVISION SEVERAGE:** It is hereby declared to be the intention of the governing authority of this municipality that the sections, subsections, paragraphs, sentences, clauses and phrases are severable, and if any phrase, clause, sentence, paragraph, subsection, or section of this Ordinance shall be declared invalid or unconstitutional by the valid judgment or decree of any court or competent jurisdiction, such invalidity or unconstitutionality shall not effect any of the remaining portions of this Ordinance so held to be invalid.

3. **ORDINANCE SUPERSEDES PREVIOUS INCONSISTENT LEGISLATION:** All Ordinances or parts of Ordinances inconsistent herewith, which may have heretofore been passed by the Simpsonville City Council, are hereby repealed.

(SIGNATURE PAGE FOLLOWS)

ORDINANCE NO.: Z-2026-01

Page 2

This Ordinance shall be effective upon second and final reading by the City Council.

SIGNATURE OF MAYOR:

Paul Shewmaker

ATTEST:

APPROVED AS TO FORM:

Ashley Clark
City Clerk

Daniel Hughes
City Attorney

First Reading: April 14, 2026
Second Reading: May 12, 2026

EXHIBIT "A"



Z-2026-01 206 Ladean Ct Rezone to B-G



February 24, 2026

1:1,600

Legend

-  Subject Property
-  Parcels

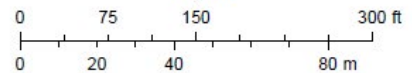
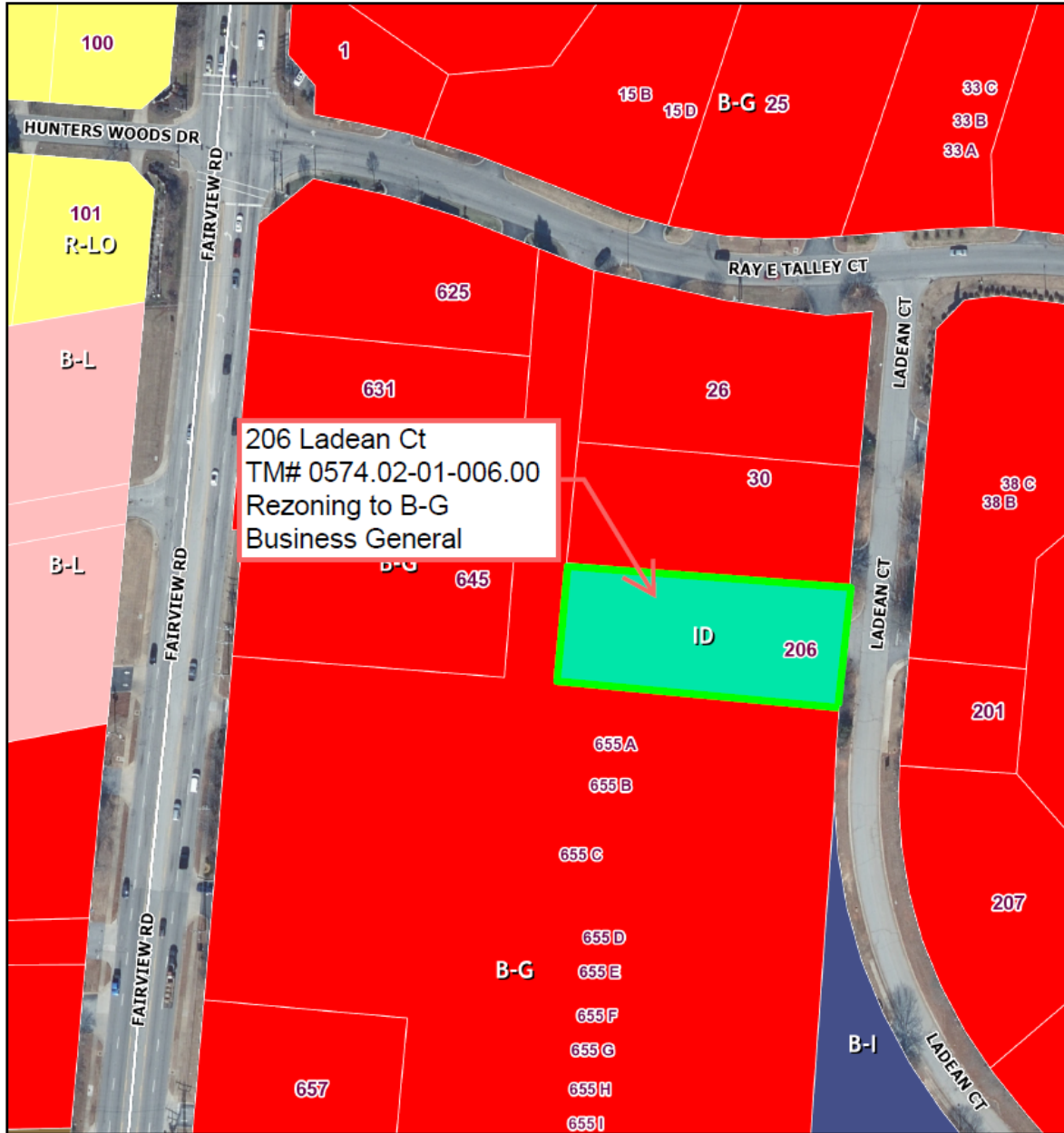

EXHIBIT B

Z-2026-01 206 Ladean Ct Rezone to B-G



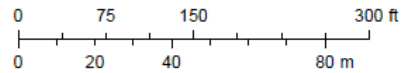

February 24, 2026

1:1,600



Legend

-  Subject Property
-  Parcels





CITY OF SIMPSONVILLE ZONING AMENDMENT (REZONING) APPLICATION

SITE/PROPERTY LOCATION:Property Address: 206 Ladean Ct, Simpsonville SC Tax Map Number: 0330000100124**APPLICANT:** Justin A HolckMailing Address: 306 Lorca DR City, State, Zip: Greenville, SC 29611
Phone Number: 541-610-2872 E-mail Address: justinaholck@gmail.com**PROPERTY OWNER** (if different from Applicant): _____Mailing Address: _____ City, State, Zip: _____
Phone Number: _____ E-mail Address: _____

	<i>Current</i>	<i>Requested</i>
Zoning District:	<u>ID</u>	<u>BG</u>
“Future Land Use Map” Designation:	<u>ID</u>	<u>BG</u>

Project Description (be specific): Change from ID zoning to BGNo. of Parcels: 1 Acreage of Parcel(s): 0.74

- Submittal Checklist*:
- Consent Letter from Property Owner (if application is not signed by property owner)
 - Cover Letter explaining your request in detail
 - Application Fee (see “Rezoning Guide”)
 - Survey/Boundary Map – 1 printed copy/1 PDF copy

*Staff reserves the right to request additional information and/or materials as necessary

I do hereby certify as property owner/authorized agent that the information shown on this application and any attached forms and/or plans is correct.

<u><i>Justin Holck</i></u> Signature	<u>Justin A Holck</u> Printed Name	<u>02/11/2026</u> Date
---	---------------------------------------	---------------------------

FOR CITY STAFF USE ONLY

Date Received: _____ By: _____ Docket #: _____ Zoning District: _____

Comments: _____ PC Review: _____ CC Review: _____

APPROVED (with conditions) DENIED

February 11, 2026

City of Simpsonville Planning Commission

118 NE Main Street

Simpsonville, SC 29681

Re: Rezoning Request – 206 Ladean Court, Simpsonville, SC

Dear Members of the Planning Commission,

Please accept this letter as a formal request to rezone the property located at 206 Ladean Court, Simpsonville, South Carolina from its current Innovative Development (ID) designation back to Business General (BG).

The purpose of this request is to restore the property's zoning classification to Business General in order to better align with surrounding commercial uses and to support appropriate business operations at this location. The Business General designation is consistent with the existing development pattern in the area and provides suitable flexibility for commercial activity while remaining compliant with all applicable municipal standards and regulations.

This proposed rezoning will not negatively impact the character of the surrounding area. Rather, it reinforces the established commercial nature of nearby properties and supports continued economic activity within the corridor.

We respectfully request review and approval of this rezoning application. Please advise if any additional documentation or supporting materials are required to assist in your evaluation.

Thank you for your time and consideration.

Sincerely,

Justin Holck

Owner

541-610-2872

justinholck@gmail.com



Z-2026-01 206 Ladean Ct Rezone to B-G



February 24, 2026

1:1,600

Legend

-  Subject Property
-  Parcels

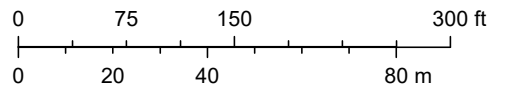

Greenville County GIS Division, Greenville, South Carolina, Greenville County GIS Division

Z-2026-01 206 Ladean Ct Rezone to B-G

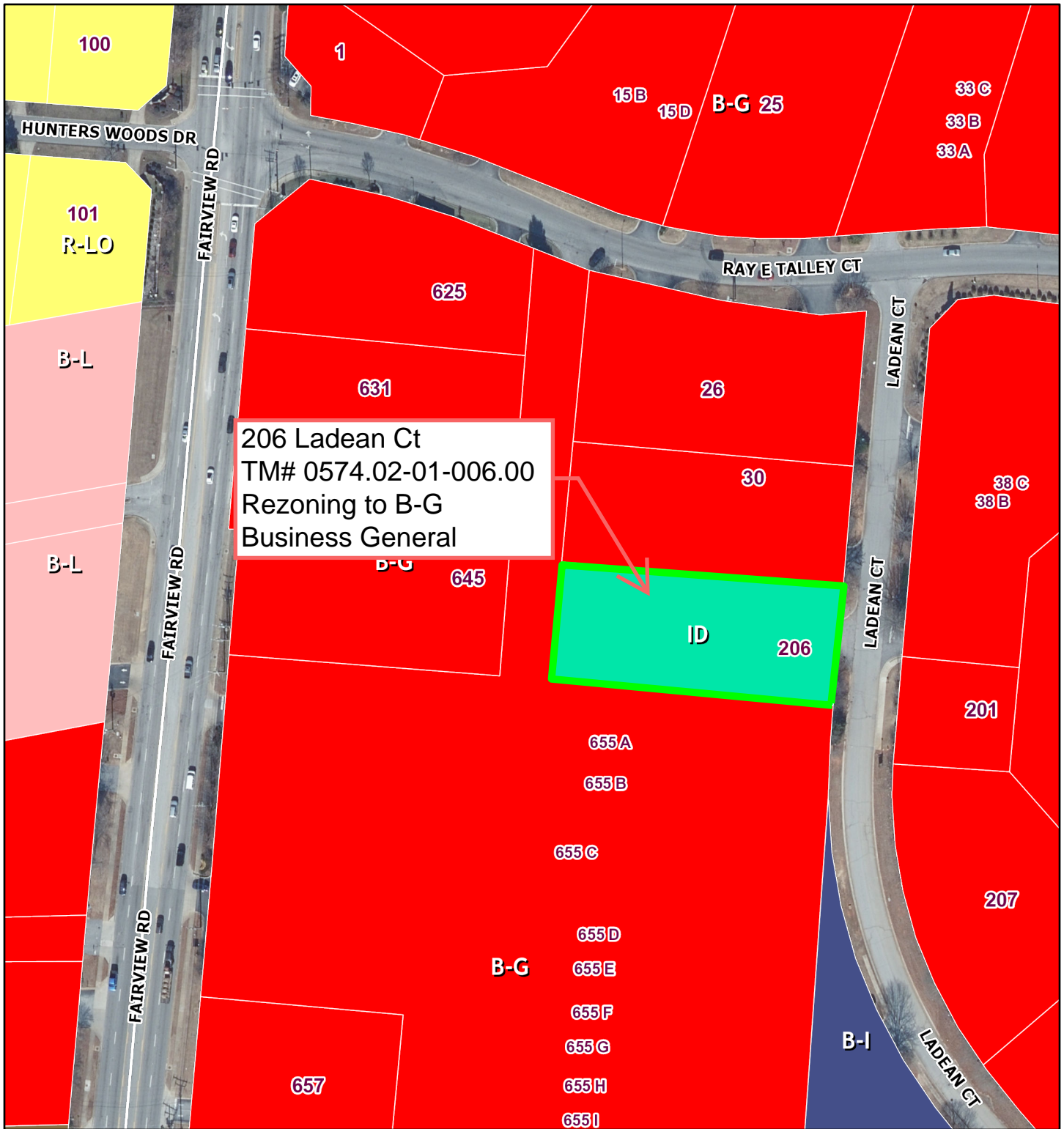

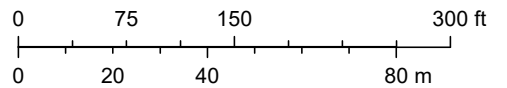

February 24, 2026

1:1,600



Legend

-  Subject Property
-  Parcels



Greenville County GIS Division, Greenville, South Carolina, Greenville County GIS Division



City of Simpsonville – Submission of Agenda Item

(Due at 12 p.m. on the Tuesday prior to the meeting)

To: Ashley Clark, Clerk of Council

From: Justin Campbell

Department: Council

Date Submitted: 04/08/2026

Please include the following item on the agenda for:

Committee of the Whole Meeting (4th Tuesday of the month) **Date:**

Business Meeting (2nd Tuesday of the month) **Date:** 04/14/2026

Agenda Item Title: Resolution R-2026-08, to accept the allocation of Community Development Block Grant and HOME Funds from GCRA as set for Program Year 2026

Summary of Item / Purpose:

To adopt resolution provided by Greenville County Redevelopment Authority to accept the allocation of Community Development Block Grant and HOME Funds from GCRA as set for Program Year 2026

Action Requested of Council:

Discussion Only

First Reading

Second Reading

Approval / Vote

Other:

Are supporting documents attached?

Yes No

STATE OF SOUTH CAROLINA
COUNTY OF GREENVILLE
CITY OF SIMPSONVILLE

**City of Simpsonville
RESOLUTION R-2026-08**

**ALLOCATION OF GREENVILLE COUNTY
CDBG AND HOME FUNDS
FOR PROGRAM YEAR 2026**

WHEREAS, the City of Simpsonville participates in the Greenville County Urban County Program; and

WHEREAS, the funds received by Greenville County available for allocation by the City of Simpsonville are as follows:

	<u>CDBG</u>	<u>HOME</u>
City Allocation	\$145,125	\$49,375
Program Income	\$ 9,400	\$0
Total Estimated	\$154,525	\$49,375

WHEREAS, the HOME funds may only be used to increase the supply of decent affordable housing for modest income persons, and CDBG funds may only be used to assist low- and moderate-income persons, reduce or eliminate slum and community blight, or meet an urgent community need where no other funding is available; and

WHEREAS, the Mayor and Council of the City of Simpsonville have discussed and reviewed projects for which these funds should be allocated by Greenville County;

NOW, THEREFORE, IT IS HEREBY RESOLVED that the City of Simpsonville accepts the allocation of funds as set forth above and budgets use of the funds as follows:

HOME funds in the amount of \$49,375 or such other amount as may be received in HOME funds in the 2026 program year to be used for new construction or reconstruction of affordable housing and assisting low- and moderate-income households in the City of Simpsonville;

CDBG funds in the amount of \$154,525 or such other amount as may be received in CDBG funds in the 2026 program year may be used on the following activities: \$22,000 in CDBG to be allocated to Public Service programs; \$49,375 for New Construction; \$128,525 for Infrastructure, and \$4,000 in disposition in the City of Simpsonville.

ANY CHANGE in CDBG and HOME funding allocations by the Greenville County Redevelopment Authority and the U.S. Department of Housing and Urban Development, increase or decrease in funding, will be distributed on a pro rata basis to all activities.

PASSED, ADOPTED AND APPROVED by the Council of the City of Simpsonville on this ___th day of _____, 2026.

CITY OF SIMPSONVILLE, SOUTH CAROLINA

BY: _____

Paul Shewmaker, Mayor

ATTEST:

Ashley Clark, City Clerk

REVIEWED:

Tee Coker, City Administrator

APPROVED AS TO FORM:

Daniel Hughes, City Attorney

**CITY OF SIMPSONVILLE
2026 COMMUNITY DEVELOPMENT BLOCK GRANT (CDBG)
AND HOME PROGRAM FACT SHEET**

Community Development Block Grant (CDBG). This grant is used to help low- and moderate-income people, prevent or eliminate blight, or meet an urgent community need where no other funding is available.

Qualified projects include:

1. ***Projects benefiting an entire neighborhood*** (public works, infrastructure, sewer, streets, sidewalks, parks, and lighting). At least 51 percent of the people in the neighborhood must be verified low to moderate income.
2. ***Projects dealing with housing*** (rehabilitation or new construction). Each household must be verified as income eligible.
3. ***Public service activities*** (education, nutrition, childcare, and medical care). Participants must be income qualified unless they are members of certain groups (seniors, disabled adults, battered and abused spouses and children, illiterates, people with HIV/AIDS, or migrant farm workers). People in these groups are automatically eligible for public service activities.
4. ***Public facilities.*** If a community center is for everyone in a neighborhood, the neighborhood must be low or moderate income. If it is for one of the special groups mentioned above, it may be located anywhere inside the city.
5. ***Projects to eliminate slums and blight on a spot basis*** – demolition activities. The site and/or the building must be declared blighted by your city codes department.
6. ***Economic Development:*** Revolving loans to existing or start up small business owners and façade improvement to commercial properties in the Central Business Areas for the purpose of creating and retaining low- and moderate-income jobs.

HOME Program. This program is used to increase the supply and provide access to decent and safe affordable housing for low- and moderate-income persons/households. Each participating household must be income qualified.

Funding Available. The City of Simpsonville has the following *estimated* allocation for Program Year 2026: **\$203,900**

Simpsonville	CDBG	HOME
Grant Estimated Allocation	\$145,125	\$49,375
Program Income	\$ 9,400	\$0
Total	\$154,525	\$49,375

Program income is generated by the repayment of CDBG or HOME funded housing loans and has the same use requirements as the original grants.

PROGRAM YEAR 2026 BEGINS JULY 1, 2026

For additional information please contact
Greenville County Redevelopment Authority • 301 University Ridge, Suite South-4300 • Greenville SC 29601
Phone: (864) 242-9801 • Fax: (864) 232-9946



City of Simpsonville – Submission of Council Agenda Item
(Due at 12 p.m. on the Wednesday prior to a Committee of the Whole meeting)

To: Tee Coker, City Administrator

Copy: Ashley Clark, Clerk of Council; Justin Campbell, Community Relations Specialist

From: Justin Campbell for Councilmember Tim Pinkerton

Department: Council W5

Date Submitted: 04/08/2026

Please include the following item on the agenda for (date of meeting): 04/14/2026

Agenda Item Title:

Impact Fees Resolution

Summary of Item / Purpose:

Approve a Resolution to approve funding for an Impact Fee Study and Capital Improvement Plan that will fund certain municipal facilities and equipment, public safety needs, and recreation facilities (parks)

Are supporting documents attached?

Yes

No

RESOLUTION R-2026-09

A RESOLUTION TO AUTHORIZE THE CITY ADMINISTRATOR TO ENGAGE A PROFESSIONAL FIRM TO COMPLETE AN IMPACT FEE STUDY AND CAPITAL IMPROVEMENT PLAN AND DIRECTING THE PLANNING COMMISSION TO INITIATE AND REVIEW THOSE STUDIES TO MAKE A RECOMMENDATION FOR AN IMPACT FEE ORDINANCE AND ASSOCIATED CAPITAL IMPROVEMENT PLAN

WHEREAS, South Carolina law authorizes municipalities to take actions not inconsistent with the Constitution and general laws of the State, regarding any subject the municipality finds necessary and proper for the health, safety, general welfare, and convenience of the municipality; and,

WHEREAS, the City of Simpsonville has experienced increased growth in population and development with increasing demands on City public facilities and the services necessary to provide for the health, safety, security, general welfare, and convenience of the City's residents and visitors; and,

WHEREAS, these services including, for example, parks and recreation services, police and fire, and other public safety services, are necessary to provide for and promote harmonious living conditions and to maintain quality standards of living for the City's residents and to encourage tourism; and,

WHEREAS, pursuant to S.C. Code §6-1-910 (the South Carolina Development Fee Act ("the Act")), the Simpsonville City Council is required to enact a Resolution directing the Planning Commission to review studies and to recommend an impact fee ordinance developed in accordance with the Act; and,

WHEREAS, the City must have a capital improvements plan prepared as well as an impact fee study to justify any impact fees that are enacted; and,

WHEREAS, City Council is authorizing the City Administrator to contract with a qualified firm to prepare the Impact Fee Study and Capital Improvement Plan; and,

WHEREAS, this study will require a funding allocation of in order to complete; and,

WHEREAS, the City Council believes that an Impact Fee Ordinance would be in the best interest of the City of Simpsonville.

NOW, THEREFORE BE IT RESOLVED by the Mayor and Council of the City of Simpsonville, in a duly assembled Council meeting, as follows:

1. **Initiation of Study.** The City of Simpsonville Planning Commission is hereby directed to initiate and complete studies to develop a proposed Impact Fee Ordinance and Capital Improvement Plan consistent with the Act.
2. **Authorization for Services.** That the City Administrator is authorized to engage the services of a professional firm specializing in development of an Impact Fee Study and Capital Improvement Plan, and to fund the cost of the Study and Plan from the General Fund Balance in an amount not to exceed \$69,600.00.

RESOLVED AND ADOPTED this _____ day of April 2026.

CITY OF SIMPSONVILLE, SOUTH CAROLINA

BY: _____
Paul Shewmaker, Mayor

ATTEST:

Ashley Clark, Municipal Clerk

APPROVED AS TO FORM:

Daniel Hughes



City of Simpsonville – Submission of Agenda Item

(Due at 12 p.m. on the Tuesday prior to the meeting)

To: Ashley Clark, Clerk of Council

From: Justin Campbell

Department: Administration

Date Submitted: 03/25/2026

Please include the following item on the agenda for:

Committee of the Whole Meeting (4th Tuesday of the month) **Date:**

Business Meeting (2nd Tuesday of the month) **Date:** 04/14/2026

Approval of Fee Schedule for Freedom of Information Act

Agenda Item Title:

Summary of Item / Purpose:

Staff would like to update and amend the current fee schedule for public records requests under the S.C. Freedom of Information Act. Legal counsel has advised that the fee schedule for FOIA requests should be approved by City Council.

Action Requested of Council:

Discussion Only

First Reading

Second Reading

Approval / Vote

Other:

Are supporting documents attached?

Yes No

RESOLUTION R-2026-10

A RESOLUTION APPROVING AN UPDATED FEE SCHEDULE FOR FREEDOM OF INFORMATION ACT REQUESTS FOR INCLUSION IN FISCAL YEAR 2026-2027 BUDGET TO GO INTO EFFECT IMMEDIATELY

WHEREAS, the City of Simpsonville processes public records requests pursuant to the South Carolina Freedom of Information Act, S.C. Code § Title 30, Chapter 4; and

WHEREAS, S.C. Code § 30-4-30(B) authorizes a public body to establish and collect reasonable fees for the search, retrieval, redaction, and copying of public records; and

WHEREAS, the City currently utilizes a fee schedule to calculate such costs, but a formal record of City Council approval has not been identified; and

WHEREAS, City Administration and the Simpsonville Police Department have reviewed and updated the fee schedule to improve clarity, consistency, and efficiency in processing requests across departments; and

WHEREAS, the proposed updates include, among other items, establishing a flat rate for reports, clarifying provisions for victims of crimes, adjusting thresholds for staff time charges, and streamlining payment practices; and

WHEREAS, City Council finds that adopting an updated fee schedule is necessary to ensure transparency, consistency, and compliance with state law while maintaining reasonable access to public records.

NOW, THEREFORE, BE IT RESOLVED THAT:

1. Approval of Fee Schedule. The updated Fee Schedule for Requests Under the Freedom of Information Act (Fee Schedule), attached hereto as Exhibit A, is hereby approved.

2. Incorporation into Budget. The approved Fee Schedule shall be incorporated into the Fiscal Year 2026–2027 Budget and shall serve as the City of Simpsonville’s official fee schedule for processing Freedom of Information Act requests.

3. Immediate Effect. Resolution R-2026-10 and the approved Fee Schedule shall take effect immediately upon adoption.

4. Future Application. The approved Fee Schedule shall remain in effect for future fiscal years unless amended or repealed by subsequent action of Simpsonville City Council.

ADOPTED this ____ day of April, 2026.

CITY OF SIMPSONVILLE, SOUTH CAROLINA

BY: _____

Paul Shewmaker, Mayor

ATTEST:

Ashley Clark, City Clerk

APPROVED AS TO FORM:

Daniel Hughes, City Attorney

EXHIBIT A:
PROPOSED FEE SCHEDULE



— CITY OF SIMPSONVILLE —

Fee Schedule for Requests Under Freedom of Information Act

Search/Retrieval Time	Search/Retrieval Time	Rate	Cost
The fee for the search, retrieval, and redaction of records shall not exceed the prorated hourly salary of the lowest paid employee who, in the reasonable discretion of the custodian of the records, has the necessary skill and training to perform the tasks.	___ hours	\$___/hour	\$___
Copies	Number of Units	Rate	Cost
A charge for printing or copies will start at 50 pages at \$.10/page.	___ copies	\$0.10/page	\$___
Media	Number of Units	Rate	Cost
Hard Drive at market rate USB Drive at market rate	___ HD ___ USB	\$___ HD \$___ USB	\$___
Reports	Number of Reports	Rate	Cost
All Police Department records requests including but not limited to: <ul style="list-style-type: none"> Incident Reports¹ Accident Reports² Local Criminal History Check Calls for Service 	___ Reports	Flat rate: \$8 per request³	\$___
TOTAL COST			\$___
DEPOSIT⁴ (Estimated Total Cost \$___ x 0.25)			\$___

A public body is permitted by S.C. Code Ann. § 30-4-30(B) of South Carolina Freedom Information Act, S.C. Code Ann. Title 30, Chapter 4 to require a fee for processing public records requests. Simpsonville City Council approved with Resolution R-2026-10 on April 14, 2026 the current FOIA fee schedule for the City of Simpsonville to be included in the Fiscal Year 2026-2027 budget and future budgets and to go into effect immediately upon approval.

¹ Victims of a crime and their legal guardians and other law enforcement agencies and certain organizations (e.g. sheriff's offices, police departments, Federal Bureau of Investigation) can receive an incident report at no charge.

² The State Collision Report does not designate a "victim" or assign "fault" but rather qualifies as a statistical document that only categorizes by "contributor." An \$8 fee will be applied to all requested collision reports. Only victims of crimes can receive free reports.

³ A charge for staff time may be made in addition to the report/s fee if the amount of time required to process the request for a report or reports is at least 1 hour.

⁴ A 25% deposit may be required prior to processing a request if the estimated total cost is at least \$20.



**EXHIBIT B:
CURRENT FEE SCHEDULE**

Fee Schedule for FOIA Requests

Search/Retrieval Time	Minutes/Hour	x Rate	= Cost
The fee for the search, retrieval, redaction or scanning of records will equal the hourly wage of the lowest paid employee who can fulfill the request.			
Copies	Number of Copies	x Rate	= Cost
If an electronic version of a record is available, and the requestor elects to receive the record electronically, then there will be no charge for copies.*		\$0.10/page	
Media	Type	Number of Units	= Cost
CD DVD Flash Drive Other			
	Type	x Rate	= Cost
Postage/Shipping	USPS UPS FedEx		
Reports	Number of Reports	x Rate + Printing (\$0.10/page)	= Cost
Incident Reports** (Simpsonville Police Department)		\$5***/report	
Accident Reports (Simpsonville Police Department)		\$5/report	
Local Criminal History Check (Simpsonville Police Department)		\$6/report	
TOTAL COST			

*Please note that if the requested records are not in an electronic form, and our office agrees to transfer the documents to an electronic format, then there may be a charge for the staff time required to transfer the documents to an electronic format.

**Victims of a crime can receive an incident report at no charge but must pick up the report at the Simpsonville Police Department at 405 E. Curtis St., Simpsonville, S.C. 29681.

***The Simpsonville Police Department may charge different fee amounts, such as printing expenses, for fulfilling FOIA requests, depending on staff hourly wage and other factors.